

G A D

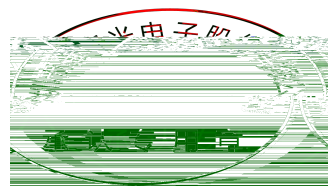

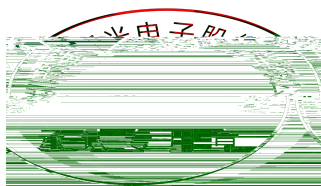

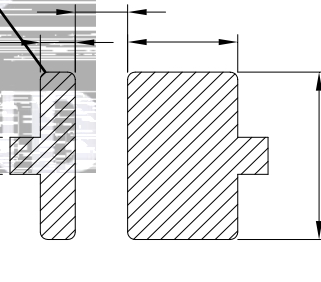

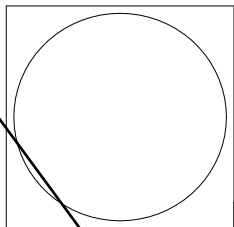
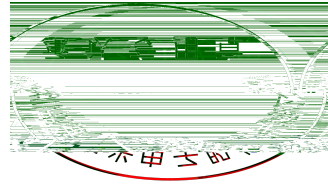
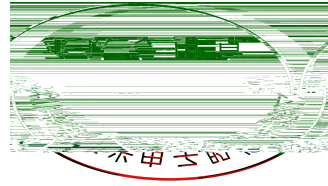

30M

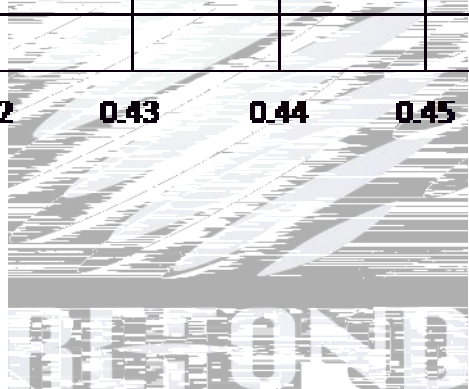
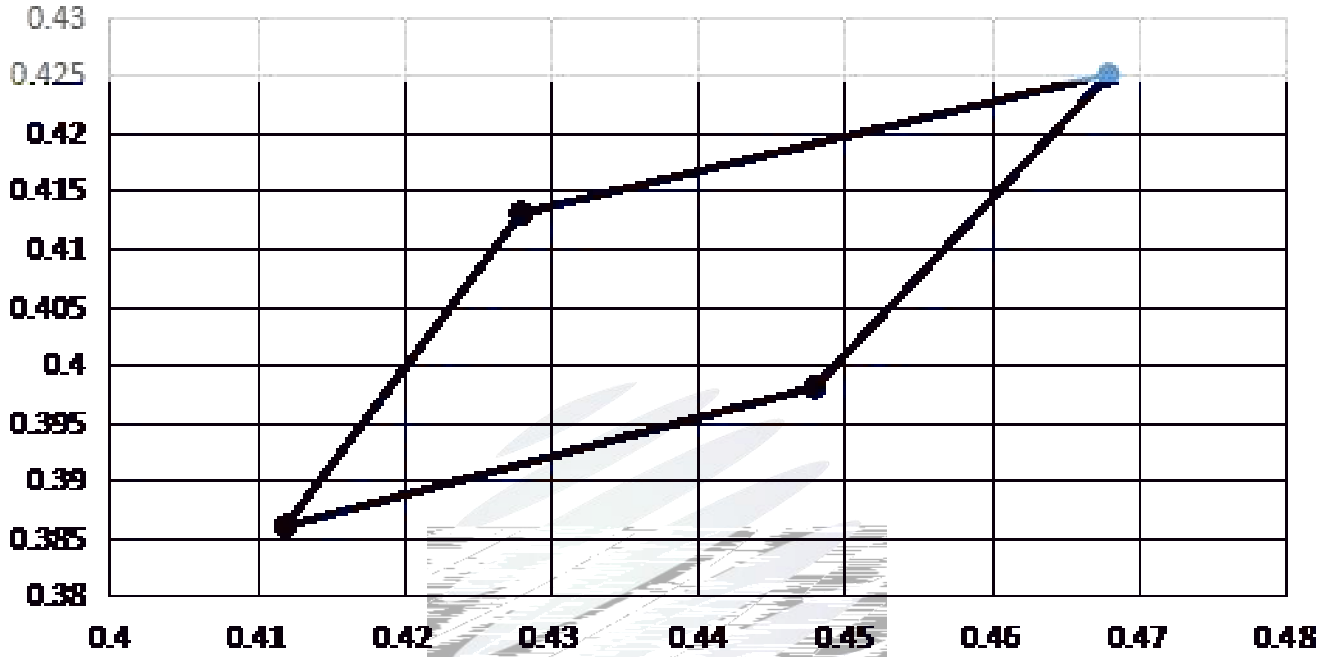

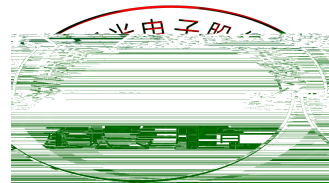

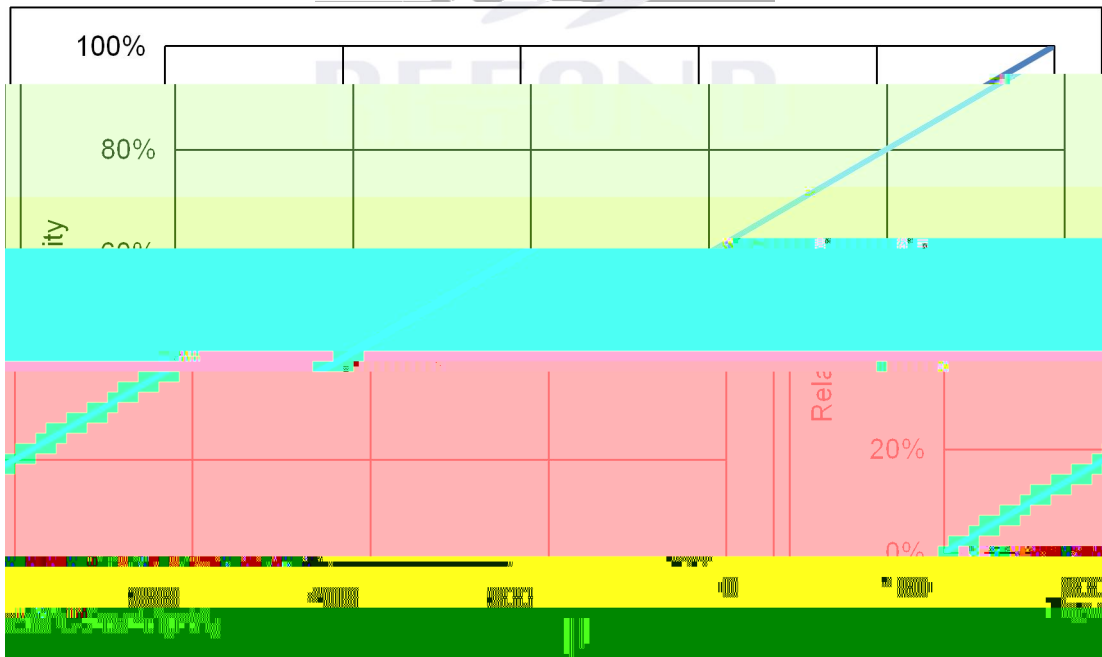
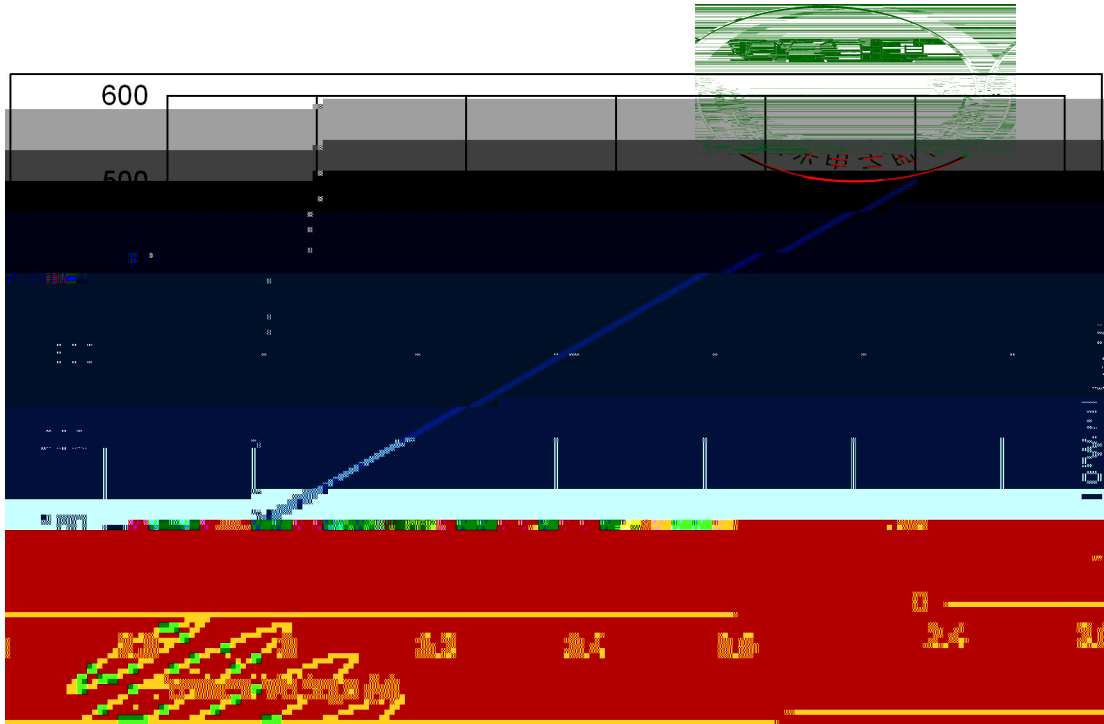

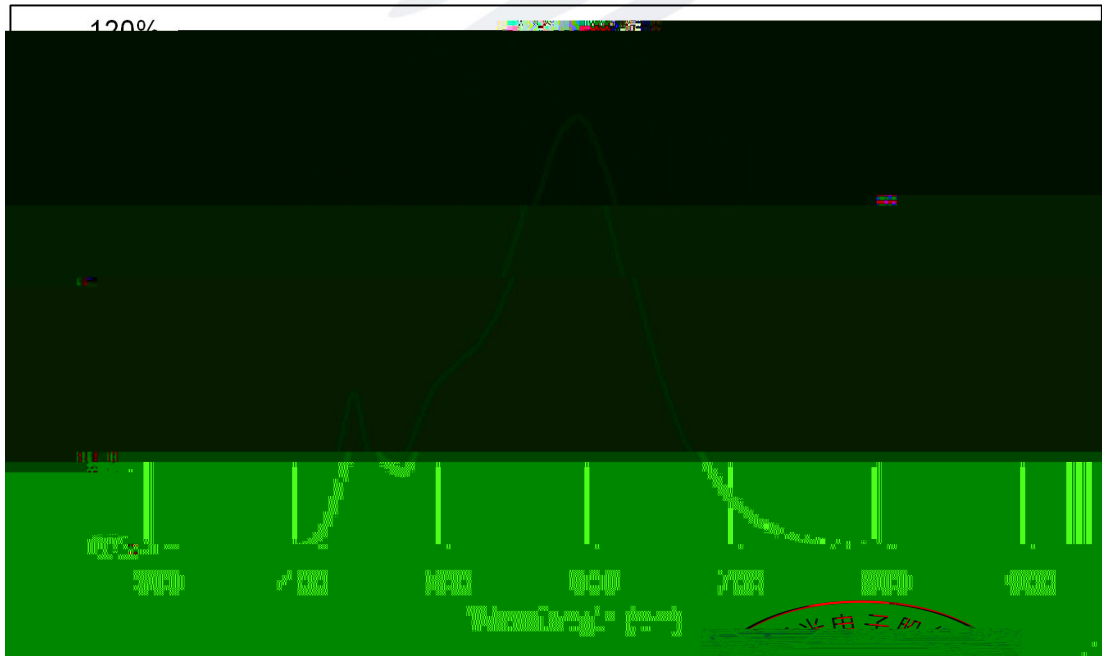
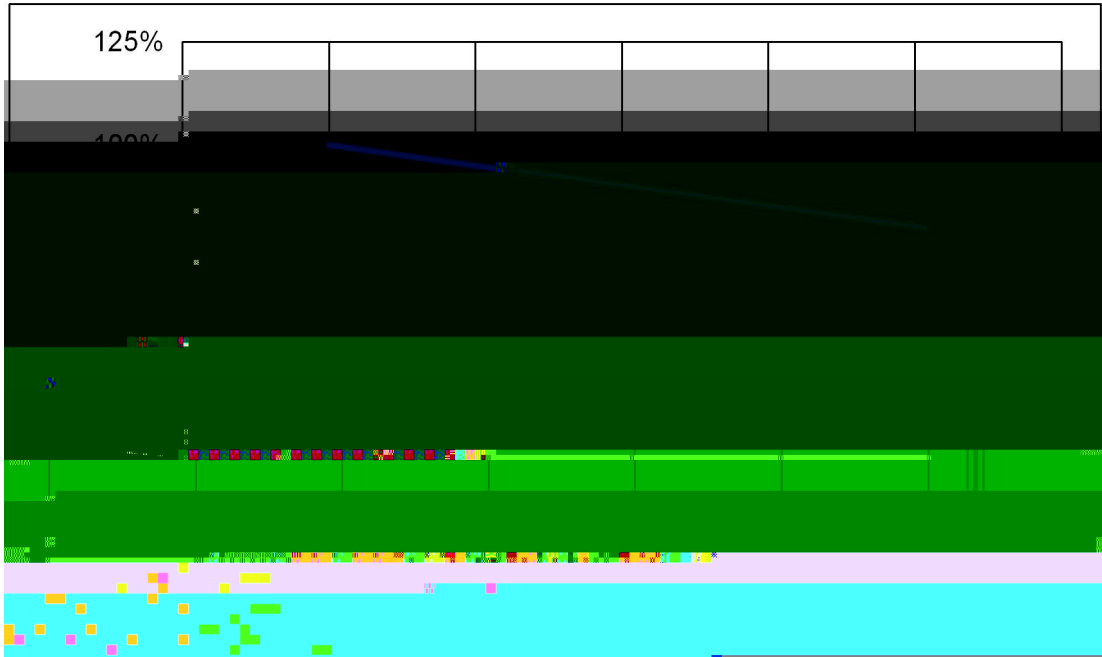

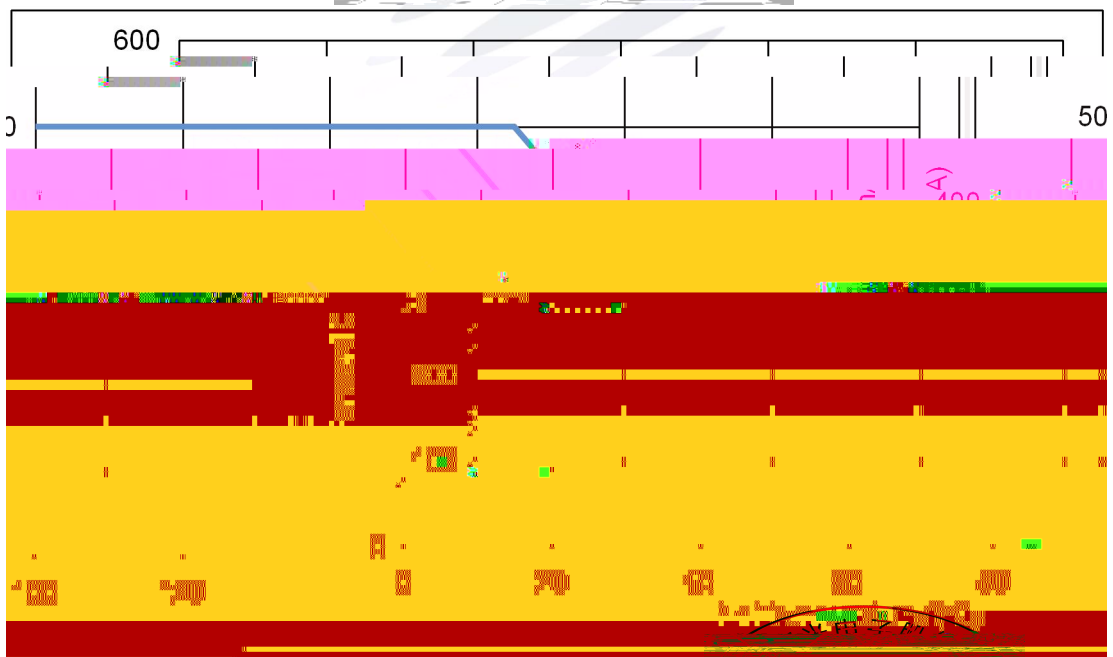
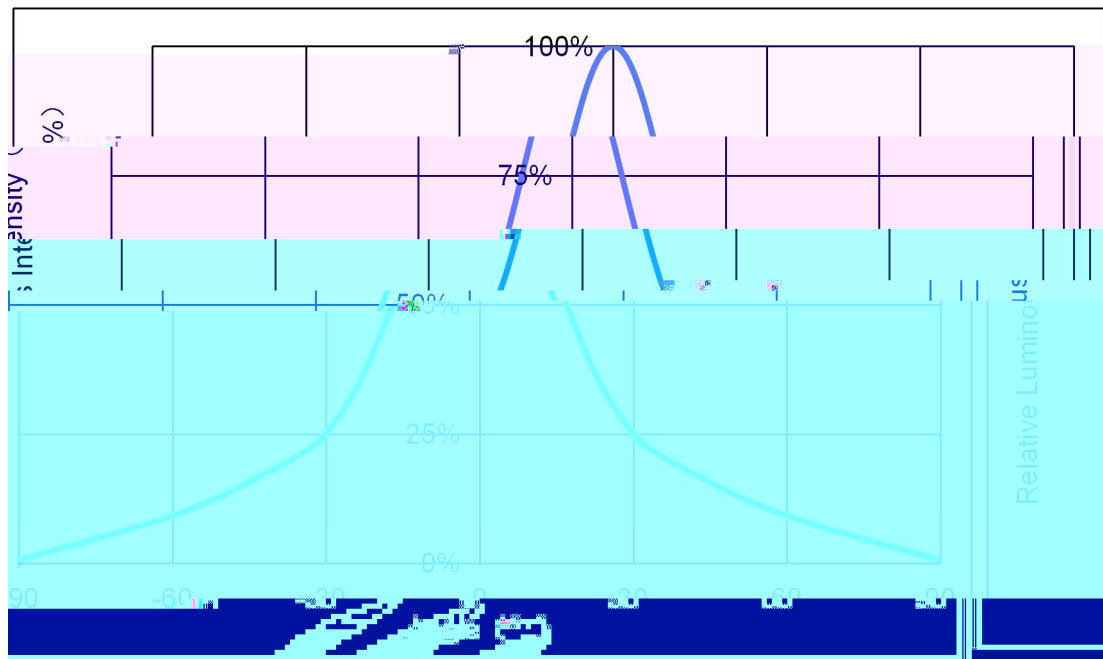

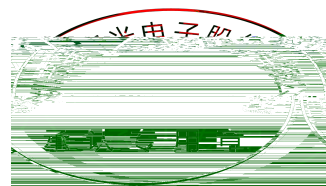
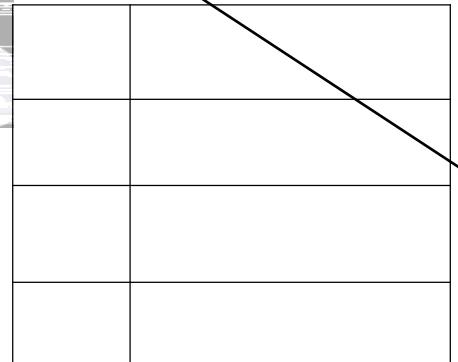
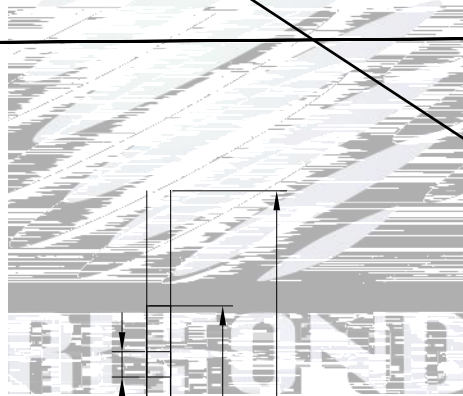
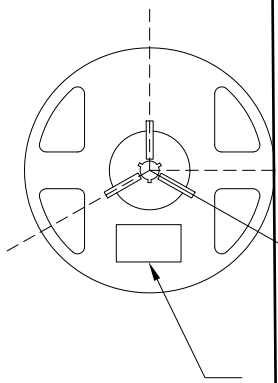
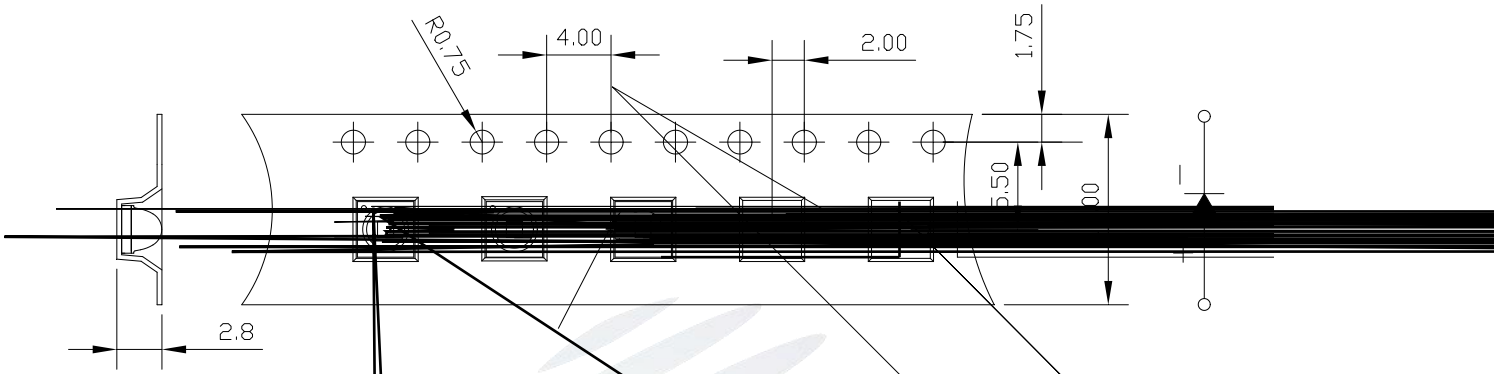

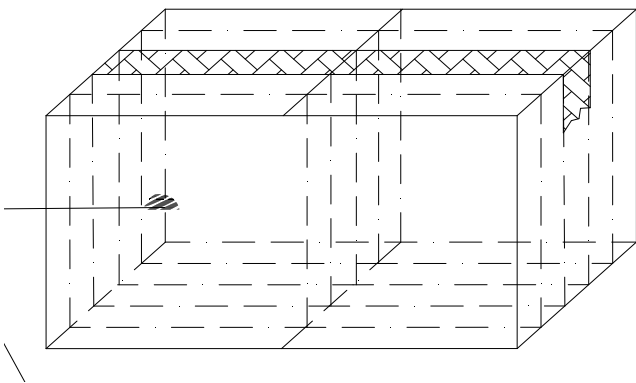
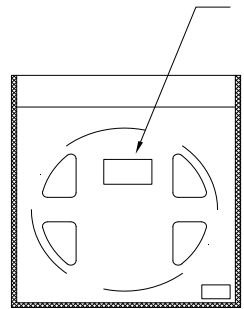
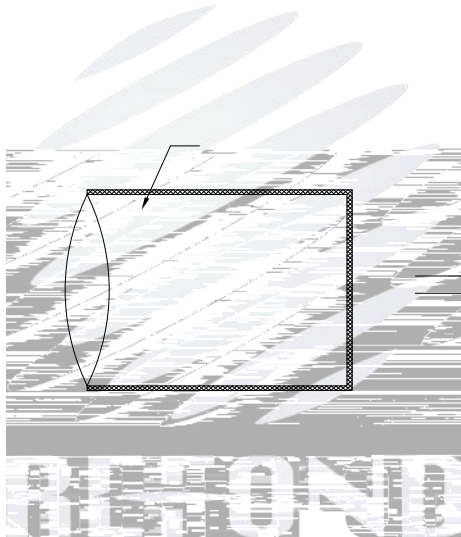
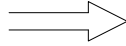
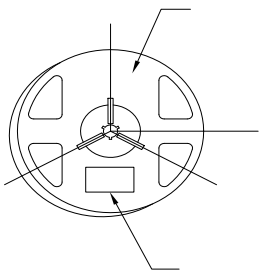

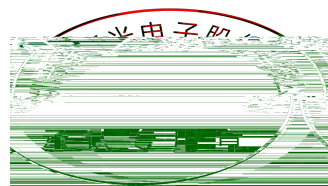

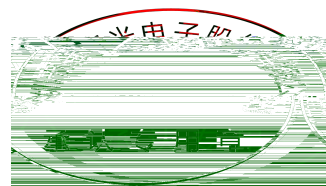



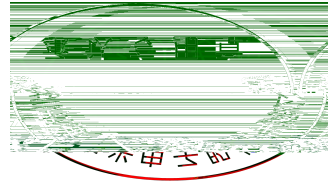





±

