

# SPECIFICATION



REFOND P/N  
RE30AX-IRT-FS

R&D  
Mass Product



# Contents

- 1. Description
  - 1.1 General Description
  - 1.2 Features
  - 1.3 Application
  - 1.4 Package Dimension
  - 1.5 Product Parameters
  - 1.6 Typical optical characteristics curves
- 2. Packaging .....8.....boa.....8pan koa. 12 Tf1 0 0 1 291.7.1 531.0
  - 2.1 Packaging Specification
    - 2.1.1 Carrier Tape Dimension ..... 10
    - 2.1.2 Reel Dimension ..... 10
    - 2.1.3 Label Form Specification ..... 11
  - 2.3 Cardboard B(....1 011)]TJET EMC /P MCID 74/Lang (en-US)>BDC BT/FF 501T EMC /P MCID 74/L

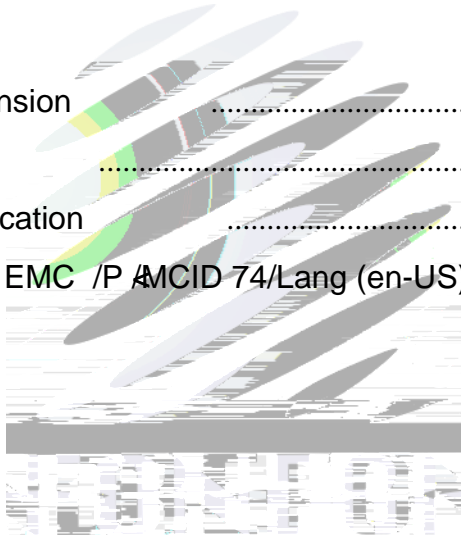

# 1. Description

## 1.1 General Description



This product uses the EMC package, it has a high reliability. it also be widely application for security monitoring and senso.

Size(mm): 3.00mmX3.00mmX2.10mm.

EMC

3.00mmX3.00mmX2.10mm.

## 1.2 Features

Low forward voltage.

850nm.

850nm

Pb-free reflow soldering application.

Moisture sensitive level:Level3.

Level 3

RoHS compliant.

RoHS

## 1.3 Application

Surveillance systems.

Infrared Illumination for cameras.

Machine vision systems.



## 1.4 Package Dimension

Fig.1-1 Top view

Fig.1-2 Polarity

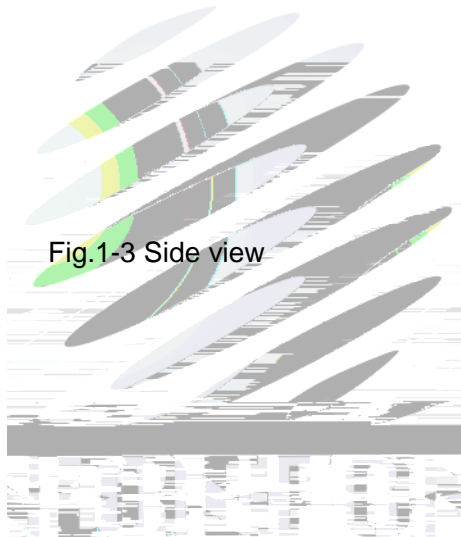

Fig.1-3 Side view

Fig.1-4 Bottom view

Fig.1-5

## 1.5 Product Parameters

Table 1-1 Electrical / Optical Characteristics at Ts=25°C

Item	Symbol	Test Condition	Value			Unit
			Min.	Typ	Max.	
Reverse Current	$I_R$	$V_R=5V$	---	---	10	uA
Forward Voltage	$V_F$	$I_F=500mA$	1.4	1.7	---	V
Peak Wavelength ( )	$\lambda_p$	$I_F=500mA$	830	850	---	nm
Spectrum Radiation Bandwidth		$I_F=500mA$	---	30	---	nm
Total radiant flux	$\Phi_e$	$I_F=500mA$	280	450	450	mW
Viewing Angle	2	$I_F=500mA$	---	100	---	deg
Thermal Resistance.	$R_{THJ-S}$	$I_F=500mA$	---	16	---	/W



Table 1-2 Absolute Maximum Ratings at Ts=25°C

Parameter	Symbol	Rating	Units
Power Dissipation	$P_D$	0.9	W
Forward Current	$I_F$	500	mA
Reverse Voltage	$V_R$	5	V
Electrostatic Discharge (HBM)	$E_{SD}$	2000	V
Operating Temperature	$T_{OPR}$	-40 ~ +85	
Storage Temperature	$T_{OPR}$	-40 ~ +100	
Junction Temperature	$T_J$	115	

**Notes**

- 1.1/10 Duty cycle, 0.1ms pulse width. 0.1ms, 1/10.
- 2.The above forward voltage measurement allowance tolerance is  $\pm 0.1V$ .  $\pm 0.1V$ .
3. Tolerance of measurement of Total radiant flux/ Radiant Intensity:  $\pm 10\%$ . /  $\pm 10\%$
4. Care is to be taken that power dissipation does not exceed the absolute maximum rating of the product.
5. All measurements were made under the standardized environment of Refond.
- 6.When the LEDs are in operation the maximum current should be decided after measuring the package temperature , junction temperature should not exceed the maximum rate. LED
7. ESD yield is over 90% at 2000V ESD (HBM). ESD protection during products handing is needed. 90% LED  
ESD2000V



## 1.6 Typical optical characteristics curves

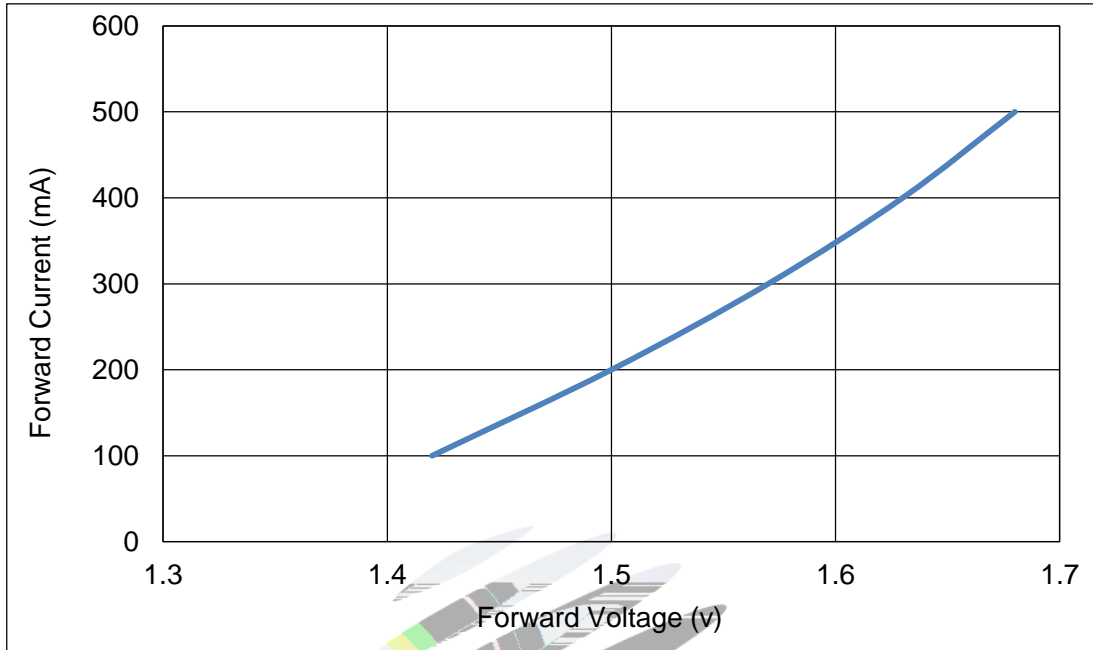

Fig 1-6 Forward Voltage Vs. Forward Current

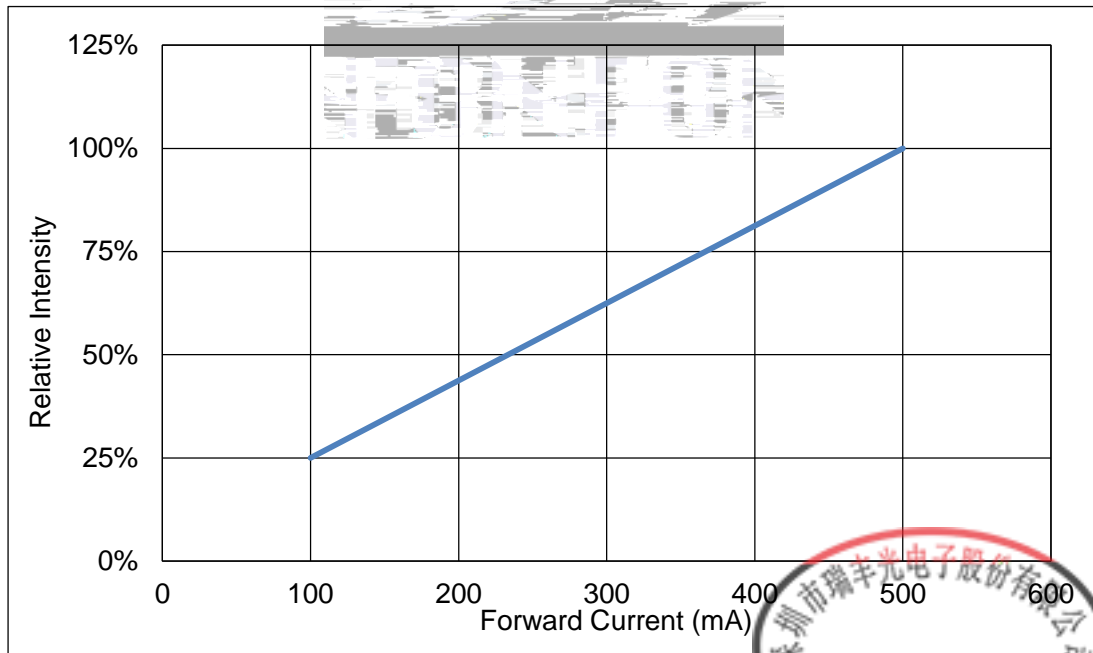
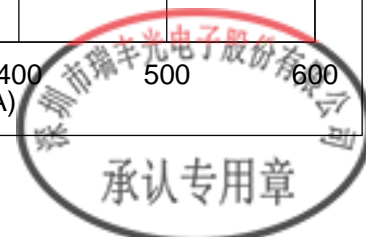

Fig 1-7 Forward Current Vs. Relative Intensity



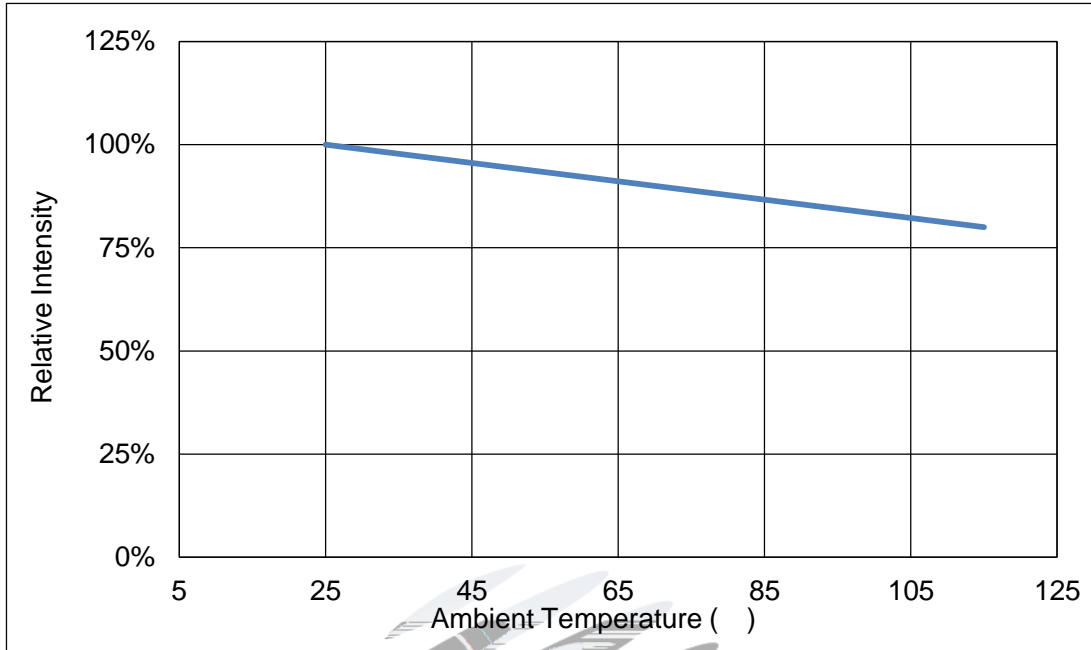

Fig 1-8 Ts Temperature Vs Relative Intensity

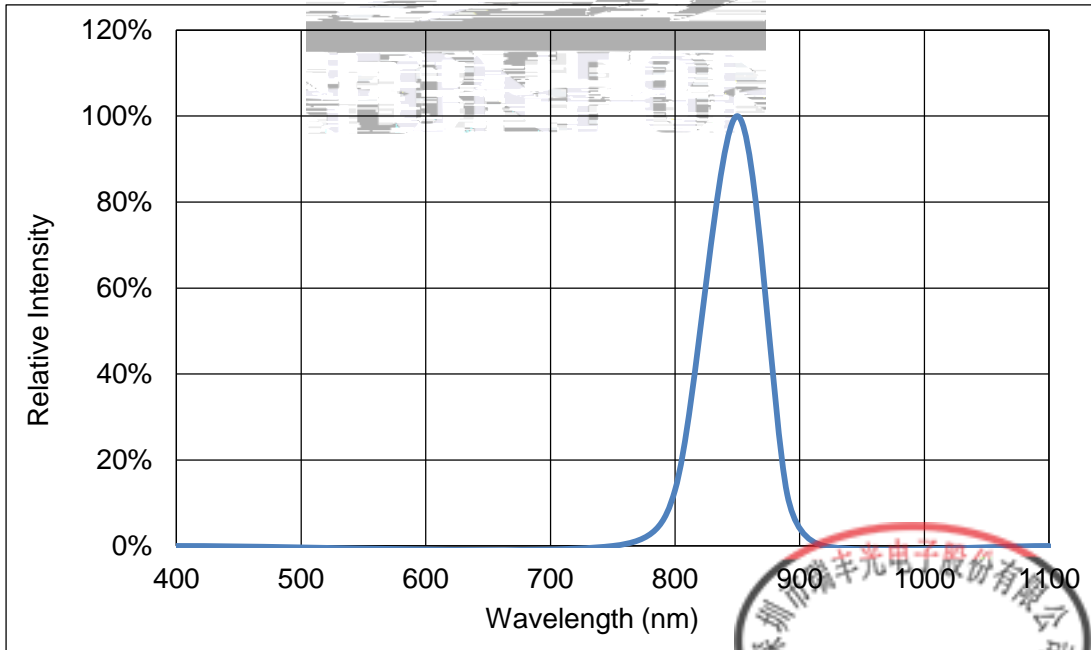
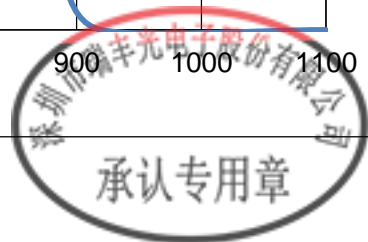
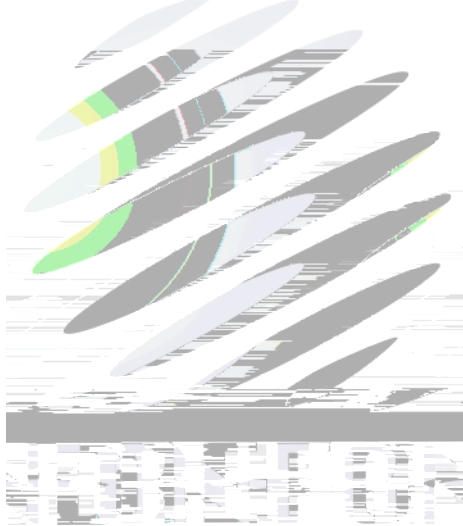
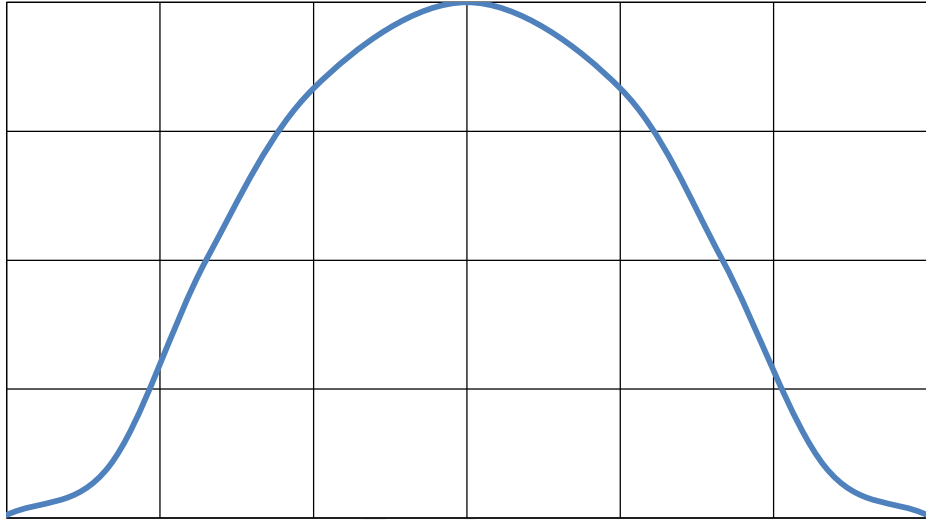

Fig 1-9 Spectrum Distribution







## 2. Packaging

### 2.1 Packaging Specification

Package: 3000pcs/reel. 3000pcs

#### 2.1.1 Carrier Tape Dimension

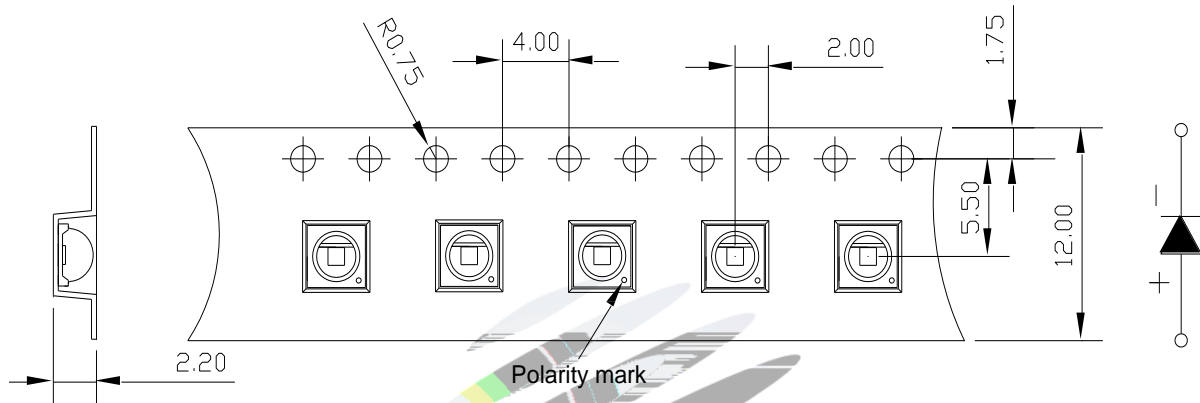

Fig.2-1 Carrier Tape Dimension

#### 2.1.2 Reel Dimension

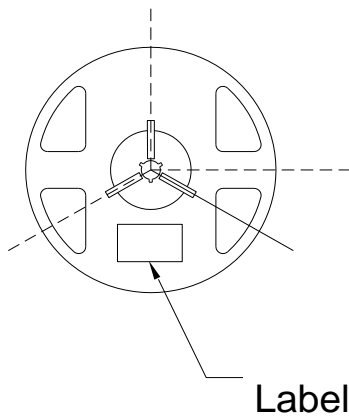

Fig.2-2 Reel Dimension

Table 2-1 Dimension

A	12.7±0.3mm
B	330.2±2mm
C	79.5±1mm
D	14.3±0.2mm

#### Notes

The tolerances unless mentioned  $\pm 0.1$ mm. Unit : mm 注：未注公差为 $\pm 0.1$ 毫米 尺寸单位：毫米



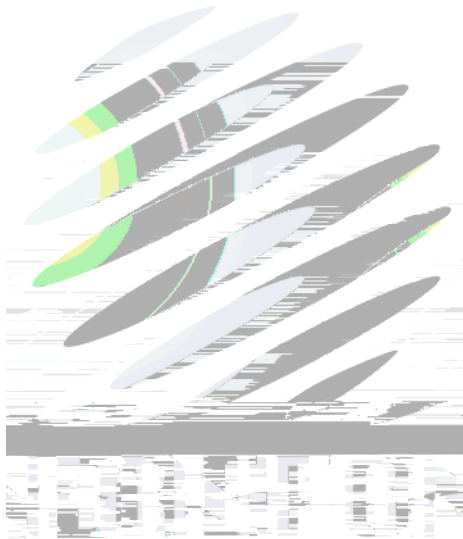

## 2.4 Reliability Test Items And Conditions

Table 2-3 Reliability Test Items And Conditions

Test Items	Ref.Standard	Test Condition	Time	Quantity	Ac/Re /
Reflow	JESD22-B106	Temp:260 max T=10 sec	3times.	10Pcs.	0/1

Temperature Cycle

JESD22-A10

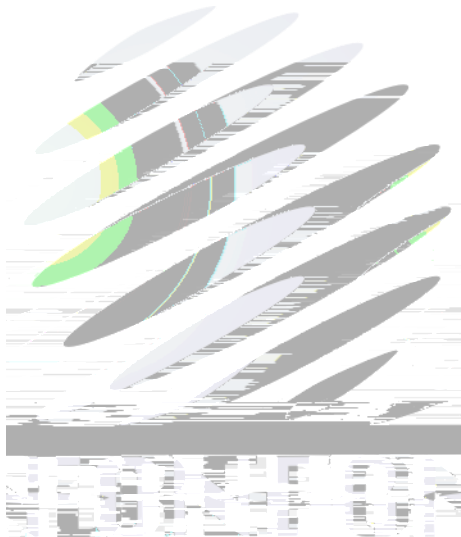

## 2.5 Criteria For Judging Damage

Table Criteria For Judging Damage

Test Items	Symbol	Test Condition	Criteria For Judgement
------------	--------	----------------	------------------------

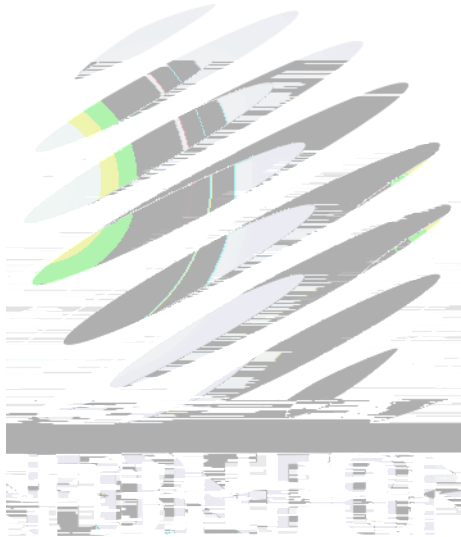

### 3. SMT Reflow Soldering Instructions SMT

#### 3.1 SMT Reflow Soldering Instructions SMT

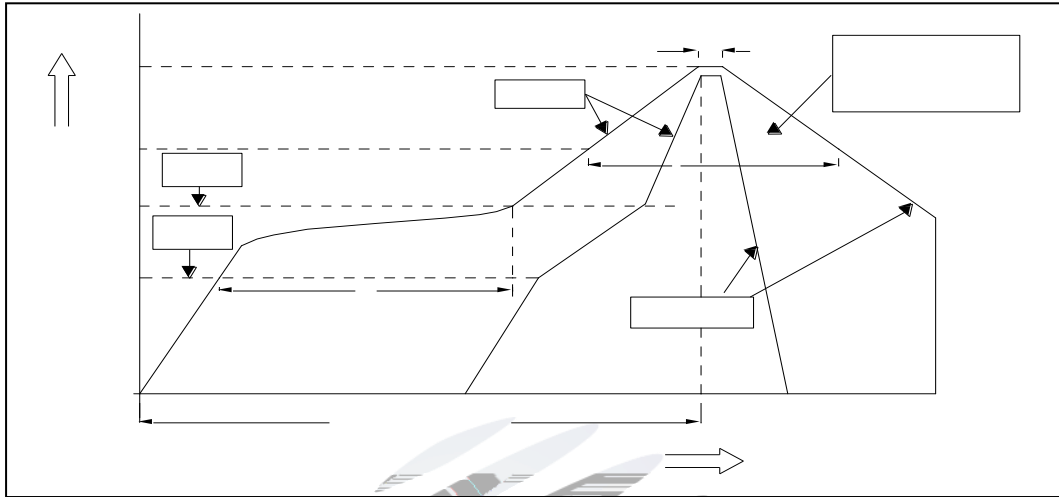
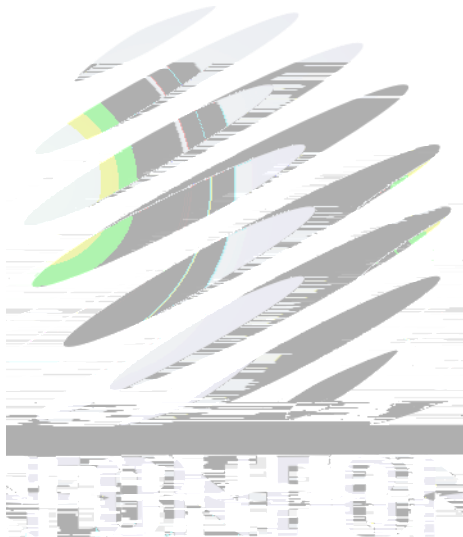

Fig.3-1 SMT Reflow Soldering Instructions SMT

Table 3-1 Parameter

Average temperature rise speed	$T_{smax}$ $T_P$	3 °C/ Max 3 °C/ s
Preheating: minimum temperature	( $T_{smin}$ )	150 °C
Preheating: Max temperature	( $T_{smax}$ )	200 °C
Preheating: Time	$T_{smin}$ $T_{smax}$	60 - 120 60s-120s
Time limited to maintain high temperature: the temperature	( $T_L$ )	217 °C
Time limited to maintain high temperature: The Time	( $t_L$ )	60 Max 60s
Peak /Classification of temperature:	/ ( $T_P$ )	260 °C
Time limit classification of peak temperature time	$t_p$	10 Max 10s
Hold time within 5 ° C with the actual peak temperature (TP) 5 °C	( $T_P$ )	30 Max 30s
Cooling speed		6 °C/ Max 6 °C/ s
Needed time from 25 °C to $T_p$	25 °C	8 Max 8 minutes

Notes



## 4. Handling Precautions

### 4.1 Handling Precautions

(1) LED operating environment and sulfur element composition cannot be over 100PPM in the LED mating usage material. This is provided for informational purposes only and is not a warranty or endorsement.

LED

100PPM.

(2) In order to prevent external material from getting into the inside of LED, which may cause the malfunction of LED, the single content of Bromine element is required to be less than 900PPM, the single content of Chlorine element is required to be less than 900PPM, the total content of Bromine element and Chlorine element in the external materials of the application products is required to be less than 1500PPM. This is provided for informational purposes only and is not a warranty or endorsement.

LED

900PPM

900PPM

1500PPM.

(3) VOCs (Volatile organic compounds) emitted from materials used in the construction of fixtures can penetrate silicone encapsulants of LEDs and discolor when exposed to heat and photonic energy. The result can be a significant loss of light output from the fixture. Knowledge of the properties of the materials selected to be used in the construction of fixtures can help prevent these issues. Refond advises against the use of any chemicals or materials that have been found or are suspected to have an adverse affect on device performance or reliability. To verify compatibility, Refond recommends that all chemicals and materials be tested in the specific application and environment for which they are intended to be used. Attaching LEDs, do not use adhesives that outgas organic vapor.

LED

LED

LED

LED

(4) Handle the component along the side surface by using forceps or appropriate tools; do not directly touch or Handle the silicone lens surface, it may damage the internal circuitry.





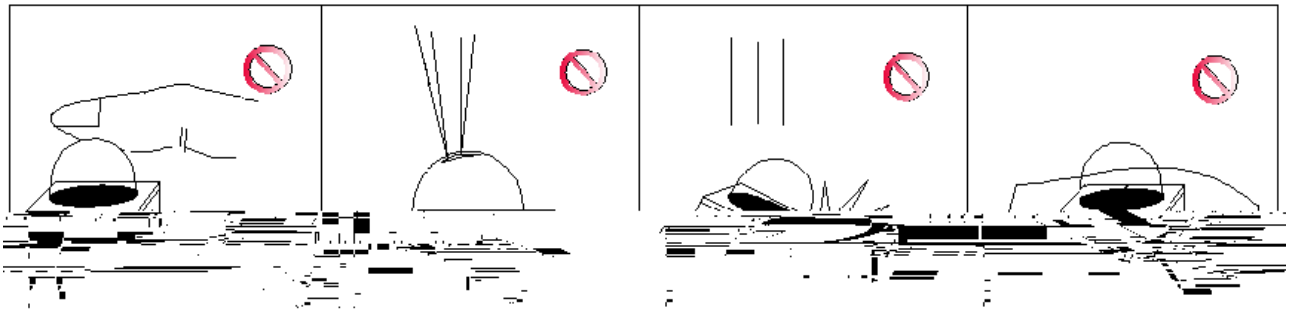

Fig 4-1

(5) In designing a circuit, the current through each LED can not be exceed the absolute maximum rating specified for each LED. In the meanwhile, resistors for protection should be applied, otherwise slight voltage shift will cause big current change, burn out may happen. The driving circuit must be designed to allow forward voltage only when it is ON or OFF. If the reverse voltage is applied to LED, migration can be generated resulting in LED damage.

LED

LED

(6) Thermal Design is paramount importance because heat generation may result in the Characteristics decline, such as brightness decreased, Color change and so on. Please consider the heat generation of the LEDs when making the system design.



LED

(7) Compared to standard encapsulants, silicone is generally softer, and the surface is more likely to attract dust, requiring special care during processing. In cases where a minimal level of dirt and dust particles cannot be guaranteed, a suitable cleaning solution must be applied to the surface after the soldering of components. Refond suggests using isopropyl alcohol for cleaning. In case other solvents are used, it must be assured that these solvents do not dissolve the package or resin. Ultrasonic cleaning is not recommended. Ultrasonic cleaning may cause damage to the LED.

LED



Table 4-1 Storage

Conditions		Temperature	Humidity	Time
Storage	Before Opening Aluminum Bag	30	75%	Within 1 Year From Date
	After Opening Aluminum Bag	30	60%	168hours 168
Baking		60± 5	-	24hours 24

(8) If the moisture absorbent material (silica gel) has faded away or the LEDs have exceeded the storage time , baking treatment should be performed after unpacking and based on the following condition ( 60±5







Declare

This specification is written both in English and in Chinese and the latter is formal.

