

# SPECIFICATION

REFOND P/N  
RF-A4E31-R15M-S6

R&D  
Mass Production



## Contents

|   |     |
|---|-----|
| 1. Description  | 3   |
| 1.1 General Description                                       | 3   |
| 1.2 Features  | 3   |
| 1.3 Application   | 3   |
| 1.4 Package Dimension   | 4   |
| 1.5 Product Parameters  | 5   |
| 1.6 Bin Range Of Forward Voltage and Luminous Flux (IF=700mA) | BIN |
| (IF=700mA)  | 6   |
| 1.7 Typical Optical Characteristics Curves                    | 7   |
| 2. Packaging  | 11  |
| 2.1 Packaging Specification                                   | 11  |
| 2.1.1 Carrier Tape Dimension                                  | 11  |
| 2.1.2 Reel Dimension  | 11  |
| 2.1.3 Label Form Specification                                | 12  |
| 2.2 Moisture Resistant Packing                                | 12  |
| 2.3 Cardboard Box   | 12  |
| 2.4 Reliability Test Items And Conditions                     | 13  |
| 2.5 Criteria For Judging Damage                               | 14  |
| 3. SMT Reflow Soldering Instructions SMT                      | 15  |
| 3.1 SMT Reflow Soldering Instructions SMT                     | 15  |
| 4. Handling Precautions                                       | 17  |
| 4.1 Handling Precautions                                      | 17  |



## 1. Description

### 1.1 General Description

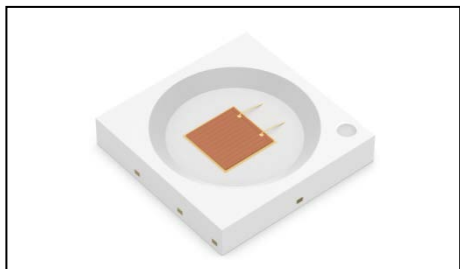

The Red source color devices are made with AlGaInP on Substrate Light Emitting Diode .  
Product Package: 3.0\*3.0\*0.55mm.

LED AlGaInP

3.0\*3.0\*0.55mm

### 1.2 Features

EMC Package. EMC

Extremely wide viewing angle.

Suitable for all SMT assembly and solder process. SMT

Available on tape and reel.

Moisture sensitivity level: Level 2. Level2

Compliance with RoHS and REACH. RoHS REACH

Qualifications: The product qualification test plan is based on the guidelines of AEC-Q102 Stress Test Qualification for Automotive Grade Discrete Semiconductors

AEC-Q102

### 1.3 Application

Automotive Lighting Interior and Exterior.



### 1.4 Package Dimension

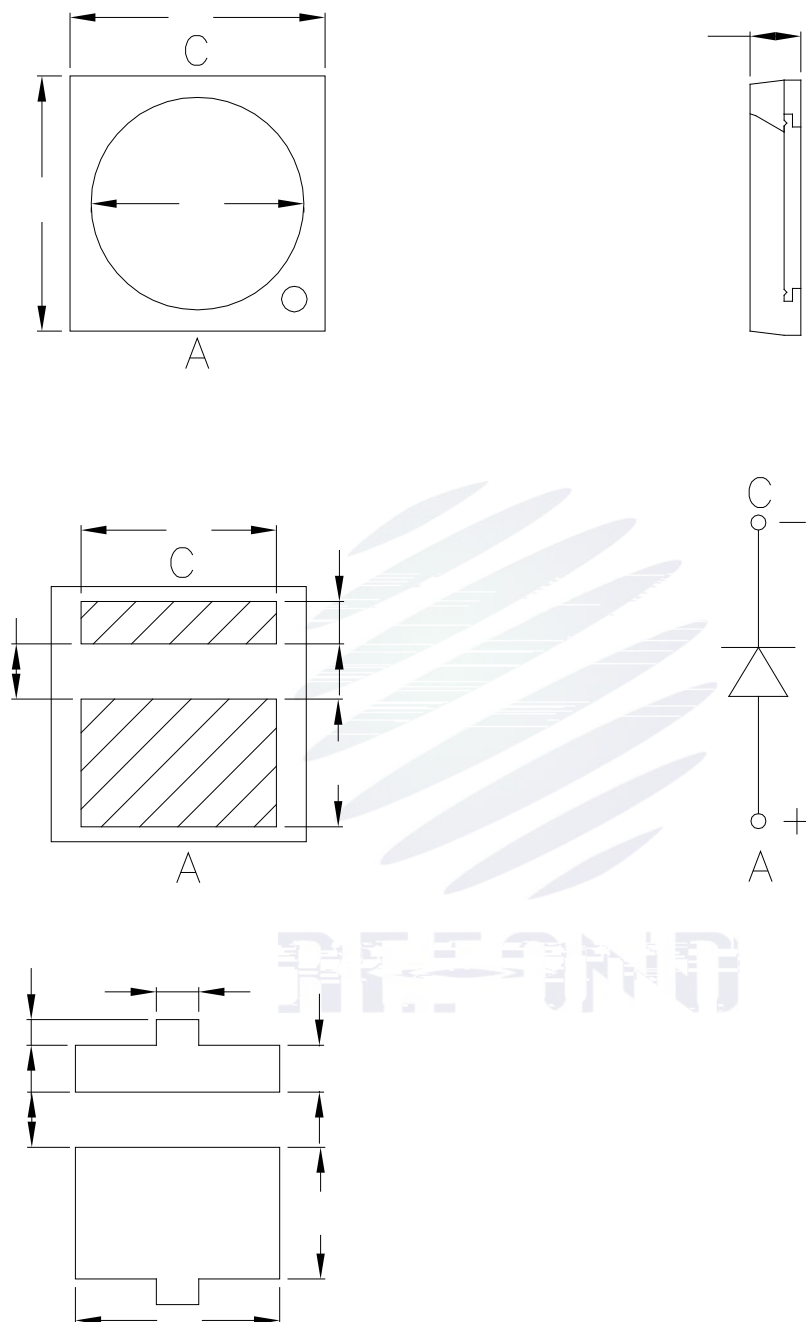

#### Notes

1. All dimensions units are millimeters.
2. All dimensions tolerances are  $\pm 0.05\text{mm}$  unless otherwise noted.



$\pm 0.05$

## 1.5 Product Parameters

Table 1-1 Electrical / Optical Characteristics at Ts=25°C

| Item                | Symbol      | Test Condition | Value |      |      | Unit |
|---------------------|-------------|----------------|-------|------|------|------|
|                     |             |                | Min.  | Typ. | Max. |      |
| Forward Voltage     | $V_F$       | IF=700mA       | 2.0   | ---  | 2.6  | V    |
| Reverse Current     | $I_R$       | VR=5V          | ---   | ---  | 10   | uA   |
| Luminous Flux       |             | IF=700mA       | 105   | ---  | 144  | lm   |
| Dominant wavelength | Wd          | IF=700mA       | 612.5 | 615  | 620  | nm   |
| Viewing Angle       | 2 1/2       | IF=700mA       | ---   | 120  | ---  | deg  |
| Thermal Resistance. | $R_{THJ-S}$ | IF=700mA       | ---   | ---  | 14   | /W   |

Table 1-2 Absolute Maximum Ratings at Ts=25°C

| Parameter                     | Symbol    | Rating     | Units |
|-------------------------------|-----------|------------|-------|
| Power Dissipation             | $P_D$     | 2184       | mW    |
| Forward Current               | $I_F$     | 840        | mA    |
| Peak Forward Current          | $I_{FP}$  | 1000       | mA    |
| Reverse Voltage               | $V_R$     | 5          | V     |
| Electrostatic Discharge (HBM) | $E_{SD}$  | 2000       | V     |
| Operating Temperature         | $T_{OPR}$ | -40 ~ +125 |       |
| Storage Temperature           | $T_{STG}$ | -40 ~ +125 |       |
| Junction Temperature          | $T_J$     | 150        |       |

## Notes

1. 1/10 Duty cycle, 10ms pulse width. 10ms, 1/10.
2. The above forward voltage measurement allowance tolerance is  $\pm 0.1V$ .  $\pm 0.1V$ .
3. The above color coordinates measurement allowance tolerance is  $\pm 0.005$ .  $\pm 0.005$ .
4. The above luminous intensity measurement allowance tolerance  $\pm 10\%$ .  
 $\pm 10\%$ .
5. Care is to be taken that power dissipation does not exceed the absolute maximum rating of the product.
6. All measurements were made under the standardized environment of Refond.
7. When the LEDs are in operation the maximum current should be decided after measuring the package temperature, junction temperature should not exceed the maximum rate. LED
8. ESD yield is over 90% at 2000V ESD (HBM). ESD protection during products handling is needed. 90% LED  
ESD2000V

## 1.6 Bin Range Of Forward Voltage and Luminous Flux (IF=700mA)

### BIN (IF=700mA)

Table 1-3

|                  |           |           |           |
|------------------|-----------|-----------|-----------|
| V <sub>F</sub> V | C0        | D0        | E0        |
|                  | 2.0-2.2   | 2.2-2.4   | 2.4-2.6   |
| lm               | SA        | SB        | TA        |
|                  | 105-117   | 117-130   | 130-144   |
| WD(nm)           | C2        | D1        | D2        |
|                  | 612.5-615 | 615-617.5 | 617.5-620 |





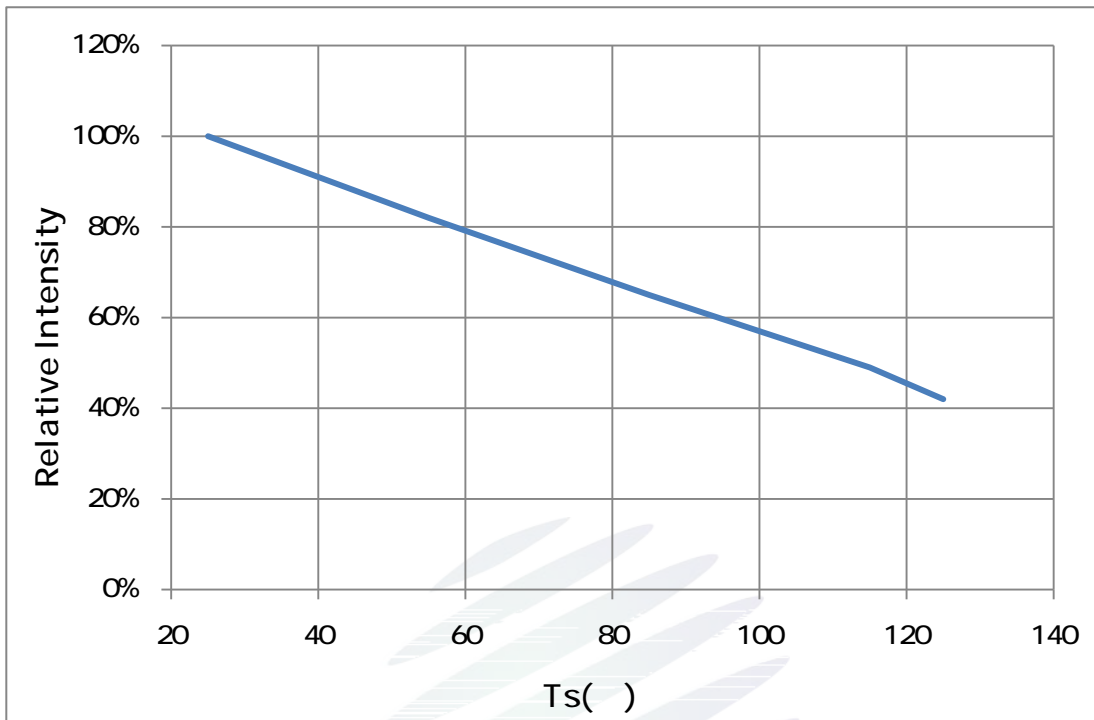

Fig. 1-9 Solder Temperature Vs Relative Intensity

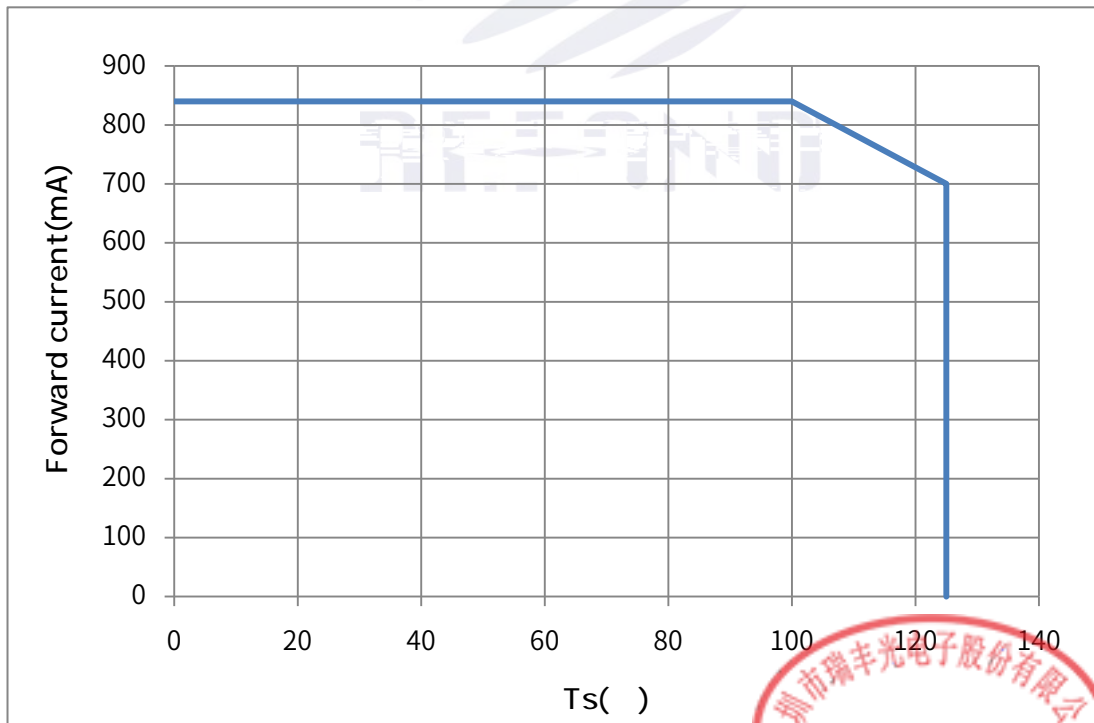
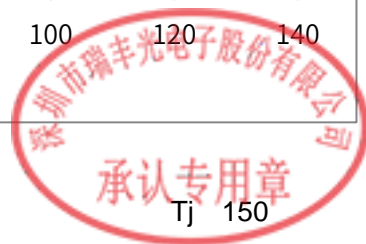

Fig. 1-10 Solder Temperature Vs Forward Current





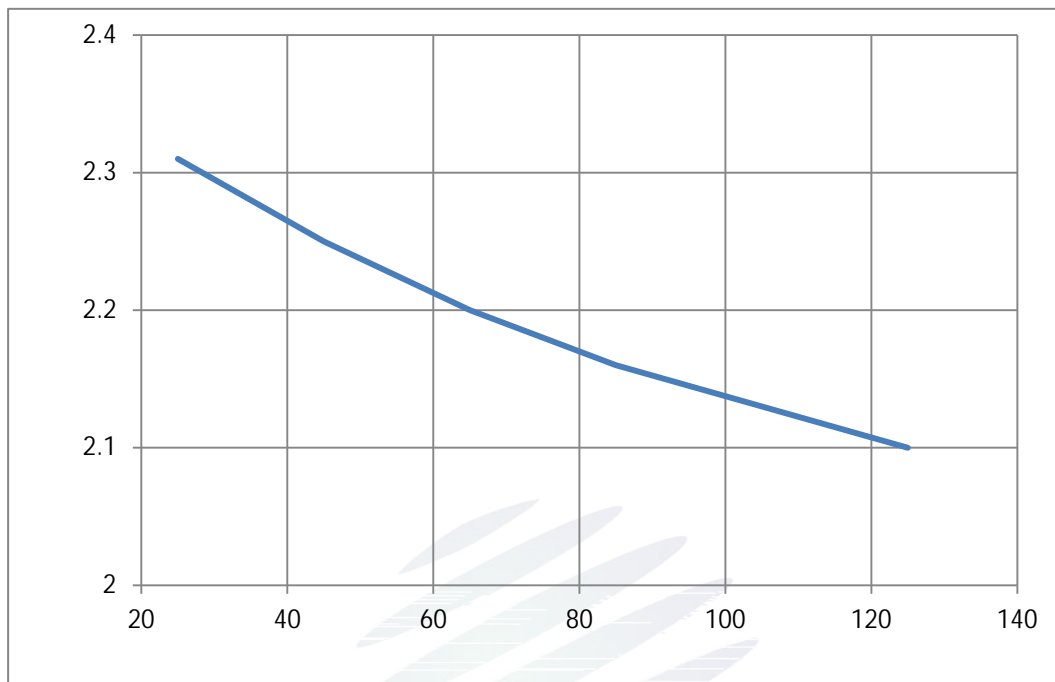

Fig. 1-11 Forward Voltage Vs Solder Temperature

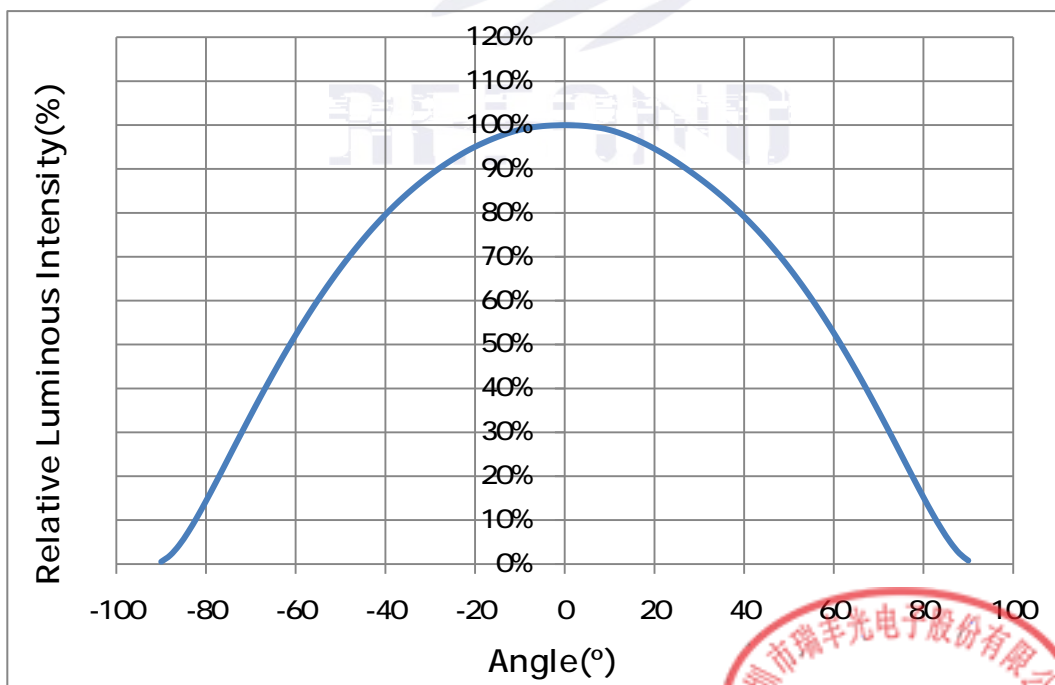
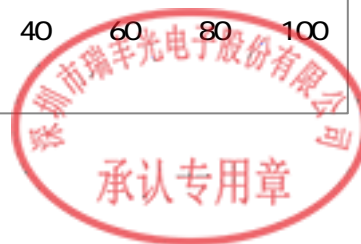

Fig. 1-12 Radiation diagram



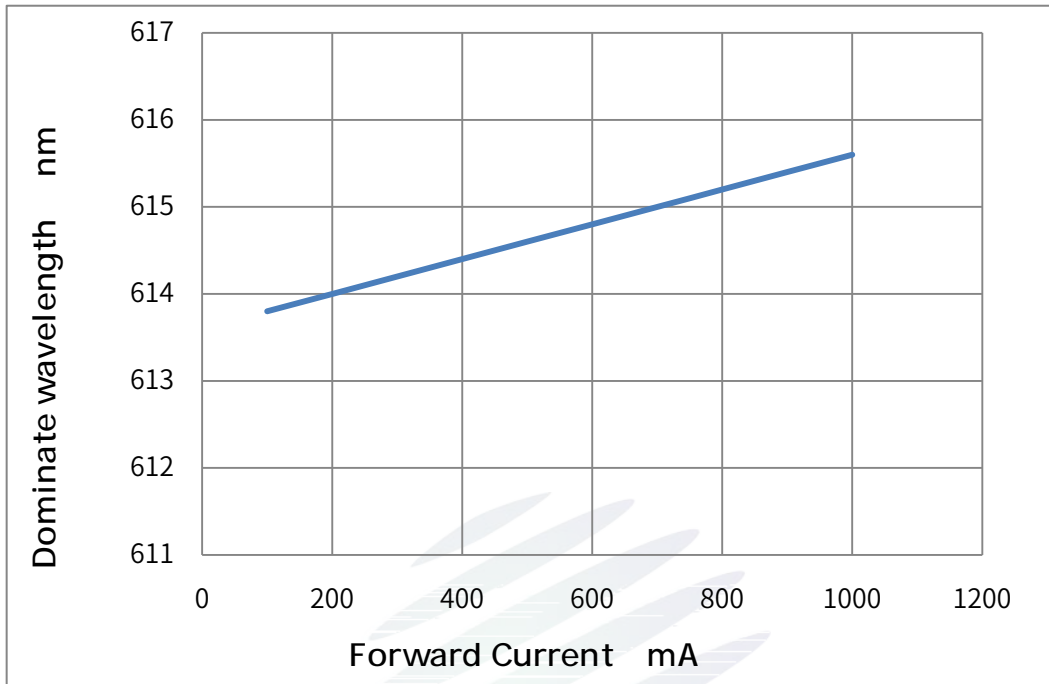

Fig. 1-12 Forward current vs. Dominate wavelength (Ts=25°C)

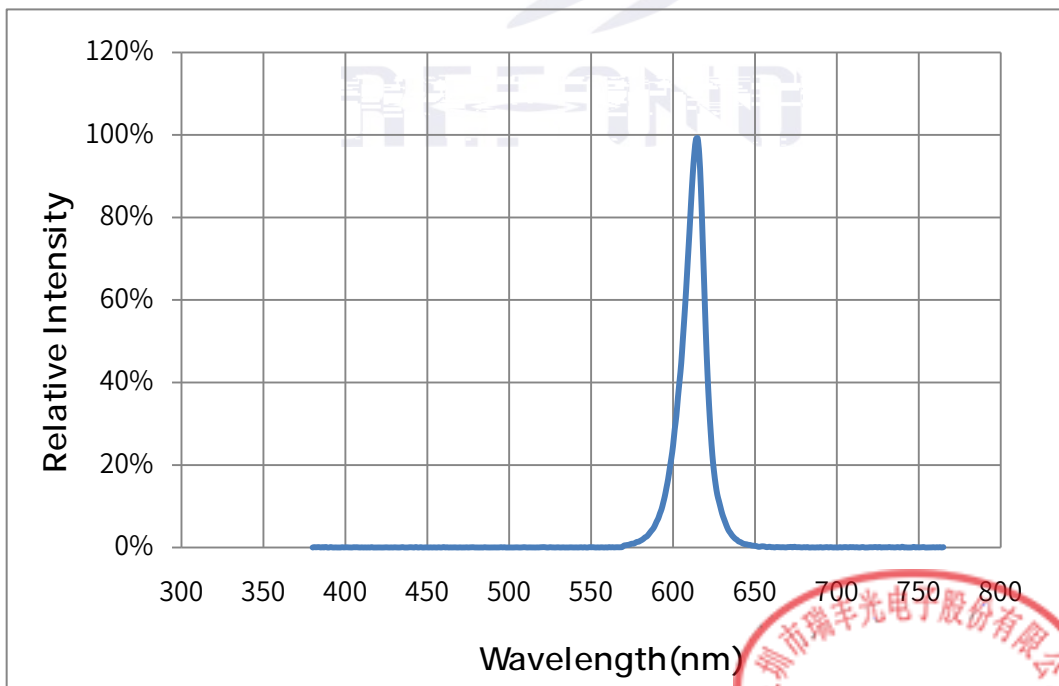

Fig. 1-14 Spectrum Distribution



## 2. Packaging

### 2.1 Packaging Specification

Package:4000pcs/reel.      4000pcs

#### 2.1.1 Carrier Tape Dimension

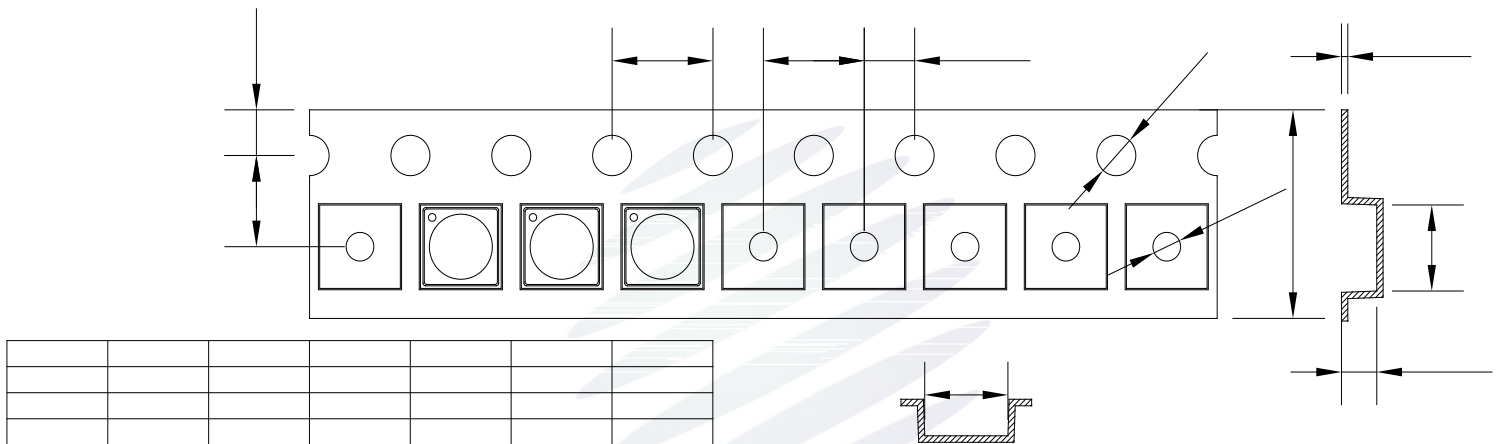

Fig.2-1 Carrier Tape Dimension

#### 2.1.2 Reel Dimension

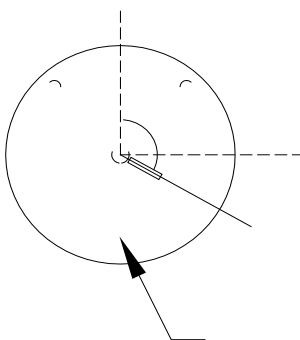

Fig.2-2 Reel Dimension

Table 2-1 Reel Dimension

|   |             |
|---|-------------|
| A | 12± 0.1mm   |
| B | 180± 1mm    |
| C | 60± 1mm     |
| D | 13.0± 0.5mm |

#### Notes

The tolerances unless mentioned  $\pm 0.1\text{mm}$ . Unit : mm

$\pm 0.1$

### 2.1.3 Label Form Specification

Table 2-2 Specification

|                |                  |
|----------------|------------------|
| PART NO.       | Part Number      |
| SPEC NO.       | Spec Number      |
| LOT NO.        | Lot Number       |
| BIN CODE       | Bin Code         |
|                | Luminous flux    |
| XY             | Chromaticity Bin |
| V <sub>F</sub> | Forward Voltage  |
| WLD            | Wavelength       |
| QTY            | Packing Quantity |
| DATE           | Made Date        |

Fig. 2-3 Label Form Specification

### 2.2 Moisture Resistant Packing



Fig.2-4 Moisture Resistant Packing

### 2.3 Cardboard Box

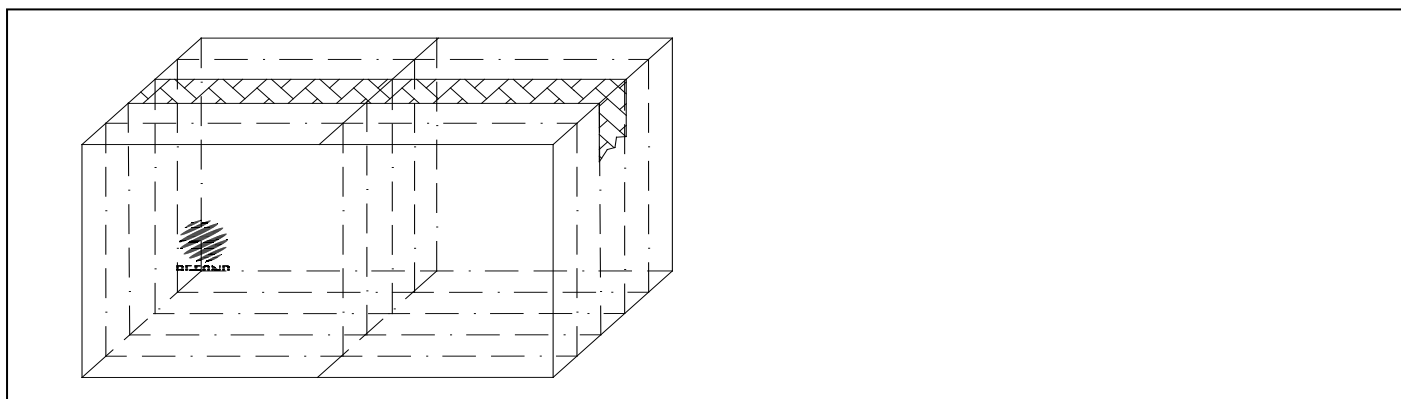

Fig.2-5 Cardboard Box

## 2.4 Reliability Test Items And Conditions

Table 2-3 Reliability Test Items And Conditions

| Test Items                                  | Ref.Standard           | Test Condition                | Time       | Quantity | Ac/Re<br>/ |
|---|------------------------|-------------------------------|------------|----------|------------|
| Reflow                                      | JESD22-B106            | Temp:260 max<br>T=10 sec      | 2times     | 20pcs.   | 0/1        |
| MSL2<br>2                                   | JESD22-A113            | 85 / 60%RH                    | 168 hrs.   | 20pcs.   | 0/1        |
| Thermal Shock                               | JEITAED-4701<br>300307 | -40 15min<br>10s<br>125 15min | 1000 cycle | 20pcs.   | 0/1        |
| Life Test                                   | JESD22-A108            | Ta=125<br>If=700mA            | 1000hrs.   | 20pcs.   | 0/1        |
| High Temperature<br>High Humidity Life Test | JESD22-A101            | 85 / 85%RH<br>If=700mA        | 1000hrs.   | 20pcs.   | 0/1        |



## 2.5 Criteria For Judging Damage

Table 2-4 Criteria For Judging Damage

| Test Items      | Symbol | Test Condition     | Criteria For Judgement |             |
|-----------------|--------|--------------------|------------------------|-------------|
|                 |        |                    | Min.                   | Max.        |
| Forward Voltage | $V_F$  | $I_F=700\text{mA}$ | -                      | U.S.L*)x1.1 |
| Reverse Current | $I_R$  | $V_R = 5V$         | -                      | U.S.L*)x2.0 |
| Luminous Flux   |        | $I_F=700\text{mA}$ | L.S.L*)x0.7            | -           |

### Notes

1.U.S.L: Upper standard level

L.S.L: Lower standard level

2.The above reliability tests is based on the verification of a single/strip LED of Refond's existing experimental platform, the reliability experiment was taken under good heat dissipation conditions. when customers applies



Notes

(1)Reflow soldering should not be done more than twice. If more than 24 hours between the two solderings ,LED will be damaged.

24 LED

(2)When soldering , do not put stress on the LEDs during heating.

3.1.1 Repairing

Repairing should not be done after the LEDs have been soldered. When repairing is unavoidable,a double-head soldering iron should be used (as below figure). It should be confirmed in advance whether the characteristics of LEDs will or not be damaged by repairing.

LED

LED

3.1.2 Cautions

The encapsulated material of the LEDs is silicone. Therefore the LEDs have a soft surface on the top of package. The pressure to the top surface will be impacted on the reliability of the LEDs. Precautions should be taken to avoid the strong pressure on the encapsulated part. So when use the picking up nozzle, the pressure on the silicone resin should be proper. LED

LED

(2) Components should not be mounted on warped (non coplanar) portion of PCB. After soldering, do not warp the circuit board.LED PCB

(3) Do not apply mechanical force or excess vibration during the cooling process to normal temperature after soldering. Do not rapidly cool device after soldering.





## 4. Handling Precautions

### 4.1 Handling Precautions

(1) LED operating environment and sulfur element composition cannot be over 100PPM in the LED mating usage material. This is provided for informational purposes only and is not a warranty or endorsement.

LED 100PPM

(2) In order to prevent external material from getting into the inside of LED, which may cause the malfunction of LED, the single content of Bromine element is required to be less than 900PPM, the single content of Chlorine element is required to be less than 900PPM, the total content of Bromine element and Chlorine element in the external materials of the application products is required to be less than 1500PPM. This is provided for informational purposes only and is not a warranty or endorsement.

LED 900PPM LED 900PPM  
1500PPM

(3) VOCs (Volatile organic compounds) emitted from materials used in the construction of fixtures can penetrate silicone encapsulants of LEDs and discolor when exposed to heat and photonic energy. The result can be a significant loss of light output from the fixture. Knowledge of the properties of the materials selected to be used in the construction of fixtures can help prevent these issues. Refond advises against the use of any chemicals or materials that have been found or are suspected to have an adverse affect on device performance or reliability. To verify compatibility, Refond recommends that all chemicals and materials be tested in the specific application and environment for which they are intended to be used. Attaching LEDs, do not use adhesives that outgas organic vapor.

LED LED

LED

(4) Handle the component along the side surface by using forceps or appropriate tools, Do not directly touch or Handle the silicone lens surface, it may damage the internal circuitry.



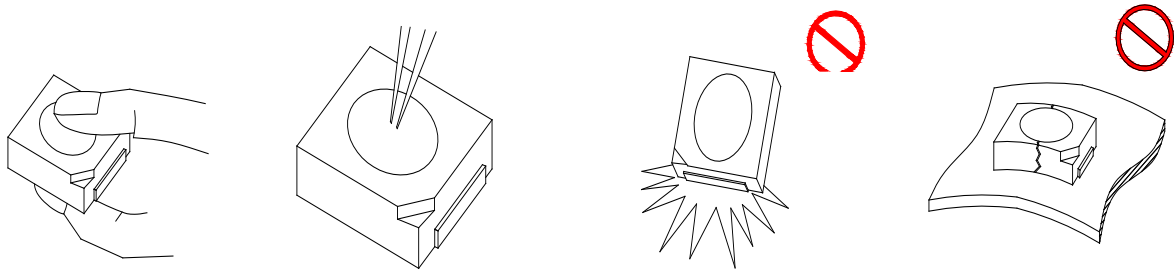

Fig 4-1Cautions

(5) In designing a circuit, the current through each LED can not exceed the absolute maximum rating specified for each LED. In the mean while, resistors for protection should be applied, other wise slight voltage shift will cause big current change, burn out may happen. The driving circuit must be designed to allow forward voltage only when it is ON or OFF. If the reverse voltage is applied to LED, migration can be generated resulting in LED damage.

LED

LED

(6) Thermal Design is paramount importance because heat generation may result in the Characteristics decline, such as brightness decreased, Color change and so on. Please consider the heat generation of the LEDs when making the system design.

LED

LED

(7) Compared to standard encapsulants , silicone is generally softer, and the surface is more likely to attract dust, requiring special care during processing. In cases where a minimal level of dirt and dust particles cannot be guaranteed, a suitable cleaning solution must be applied to the surface after the soldering of components. Refond suggests using isopropyl alcohol for cleaning. In case other solvents are used, it must be assured that these solvents do not dissolve the package or resin. Ultrasonic cleaning is not recommended. Ultrasonic cleaning may cause damage to the LED.

LED

Table 4-1 Storage

| Conditions |                             | Temperature | Humidity | Time                                      |
|------------|-----------------------------|-------------|----------|---|
| Storage    | Before Opening Aluminum Bag | 30          | 75%      | Within 1 Year From Date                   |
|            | After Opening Aluminum Bag  | 30          | 60%      | Recommended for use within 24 hours<br>24 |
| Baking     |                             | 60± 5       | -        | 24hours<br>24                             |

(8) If the moisture absorbent material silica gel has faded away or the LEDs have exceeded the storage time, baking treatment should be performed after unpacking and based on the following condition 60 5 for above 24 hours. 60

± 5 24

If the package is flatulence or damaged, please notify the sales staff to assist.

(9) Similar to most Solid state devices; LEDs are sensitive to Electro-Static Discharge (ESD) and Electrical Over Stress (EOS). LED

| Date | Revisor | Version | Verifier | Remarks |
|------|---------|---------|----------|---------|
|------|---------|---------|----------|---------|





Declare

This specification is written both in English and in Chinese and the latter is for reference.

