

Contents

1. Description	3
1.1 General Description	3
1.2 Features	3
1.3 Application	3
1.4 Package Dimension	4
1.6 Bin Range Of Forward Voltage and Luminous Flux (IF=150mA)	BIN
(IF=150mA)	6
1.7 Typical Optical Characteristics Curves	7
2. Packaging	11
2.1 Packaging Specification	11
2.1.1 Carrier Tape Dimension	11
2.1.2 Reel Dimension	11
2.1.3 Label Form Specification	12
2.2 Moisture Resistant Packing	12
2.3 Cardboard Box	12
2.4 Reliability Test Items And Conditions	13
2.5 Criteria For Judging Damage	14
3. SMT Reflow Soldering Instructions SMT	15
3.1 SMT Reflow Soldering Instructions SMT	15
4. Handling Precautions	17
4.1 Handling Precautions	17



1. Description

1.1 General Description



The Red source color devices are made with AlGaInp on Substrate Light Emitting Diode .

Product Package:2.7mmX2.0mmX0.6mm.

LED AlGaInp

2.7mmX2.0mmX0.6mm.

1.2 Features

PLCC Package.PLCC

Extremely wide viewing angle.

Suitable for all SMT assembly and solder process.

SMT

Available on tape and reel.

Moisture sensitivity level: Level 2.

Level2

RoHS compliant. RoHS

Qualifications: The product qualification test plan is based on the guidelines of AEC-Q102 Stress Test Qualification for Automotive Grade Discrete Semiconductors

AEC-Q102

1.3 Application

Automotive Lighting Interior and Exterior.



1.4 Package Dimension

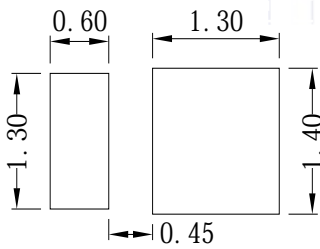
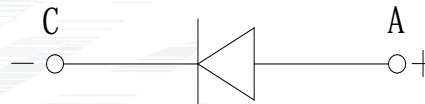
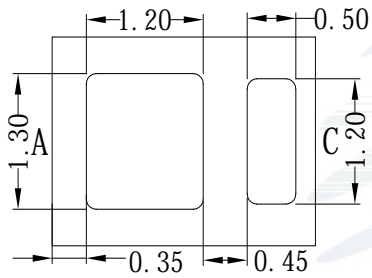
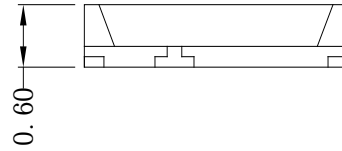
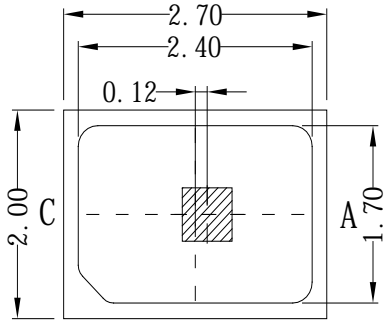

Notes

1. All dimensions units are millimeters.
2. All dimensions tolerances are $\pm 0.05\text{mm}$ unless otherwise noted.



± 0.05

1.5 Product Parameters

Table 1-1 Electrical / Optical Characteristics at Ts=25°C

Item	Symbol	Test Condition	Value			Unit
			Min.	Typ.	Max.	
Forward Voltage	V_F	$I_F=150\text{mA}$	2.0	---	2.6	V
Reverse Current	I_R	$V_R=5\text{V}$	---	---	10	μA
Dominant Wavelength	λ_D	$I_F=150\text{mA}$	617.5	---	625	nm
cLuminous Flux		$I_F=150\text{mA}$	21.8	---	30.0	lm
Viewing Angle		$I_F=150\text{mA}$	---	120	---	deg
Thermal Resistance.	R_{THJ-S}	$I_F=150\text{mA}$	---	---	45	/W

Table 1-2 Absolute Maximum Ratings at Ts=25°C

Parameter	Symbol	Rating	Units
Power Dissipation	P_D	432	mW
Forward Current	I_F	180	mA
Peak Forward Current	I_{FP}	240	mA
Reverse Voltage	V_R	5	V
Electrostatic Discharge (HBM)	E_{SD}	2000	V
Operating Temperature	T_{OPR}	-40 ~ +125	
Storage Temperature	T_{STG}	-40 ~ +125	
Junction Temperature	T_J	150	

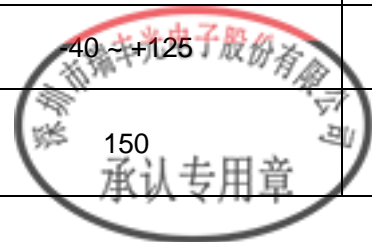

Notes

1. 1/10 Duty cycle, 10ms pulse width. 10ms, 1/10.
2. The above forward voltage measurement allowance tolerance is $\pm 0.1V$. $\pm 0.1V$.
3. The above color coordinates measurement allowance tolerance is ± 0.005 . ± 0.005 .
4. The above luminous intensity measurement allowance tolerance $\pm 10\%$. $\pm 10\%$.
5. Care is to be taken that power dissipation does not exceed the absolute maximum rating of the product.
6. All measurements were made under the standardized environment of Refond.

on the maximum current should be decided after measuring the package
 ure should not exceed the maximum rate. LED

OV ESD (HBM). ESD protection during products handing is needed. 90% LED

ard Voltage and Luminous Flux (IF=150mA)

Table 1-3

		C0	D0	E0
		2.0-2.2	2.2-2.4	2.4-2.6
	Im	KB	LA	LB
		21.8-24.2	24.2-26.9	26.9-30.0
	(nm)	D2	E1	E2
		617.5-620	620-622.5	622.5-625

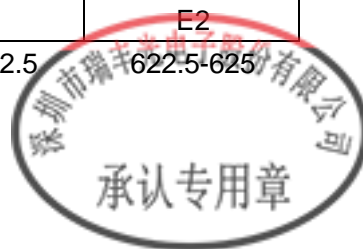

1.7 Typical Optical Characteristics Curves

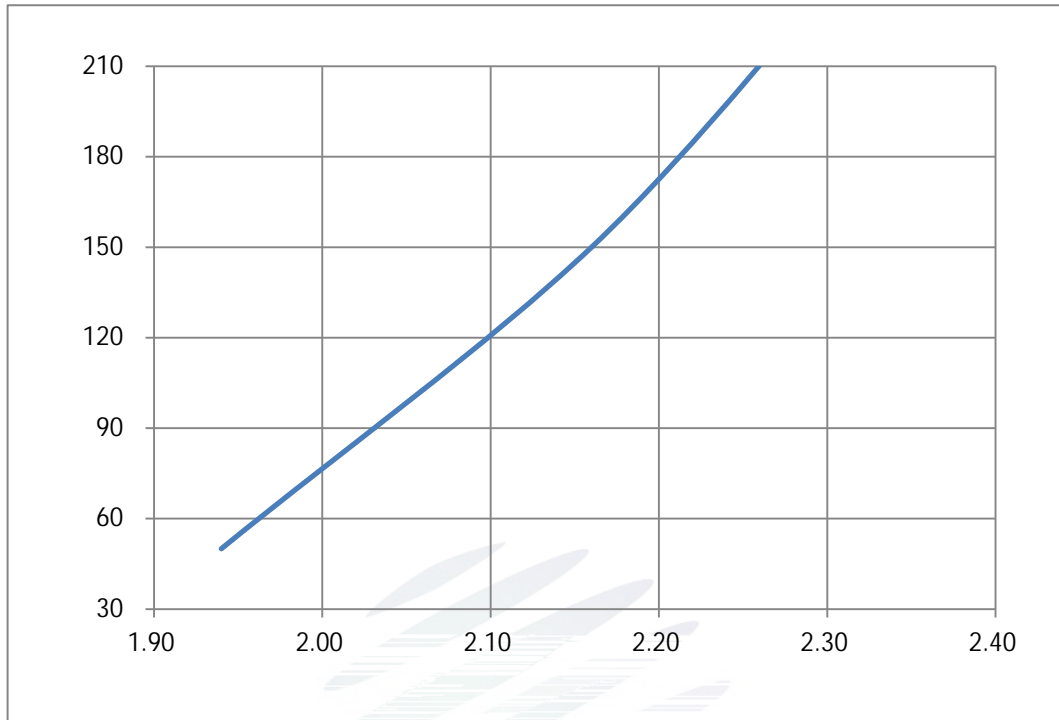

Fig. 1-7 Forward Voltage Vs Forward Current

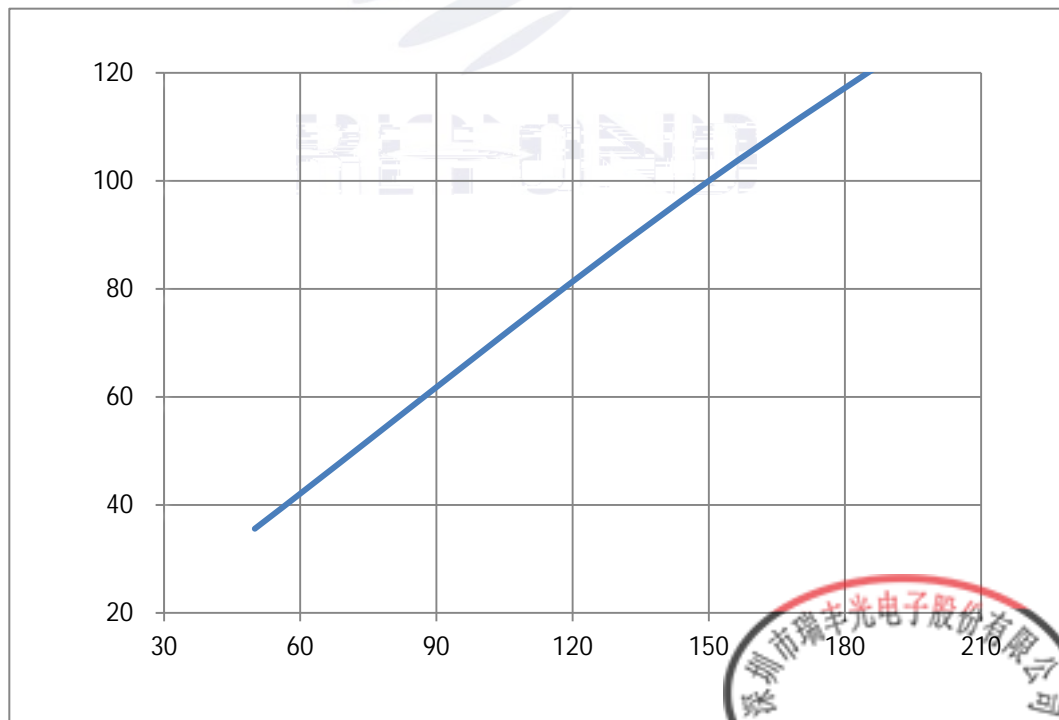
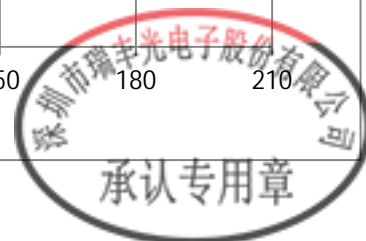

Fig. 1-8 Forward Current Vs Relative Intensity



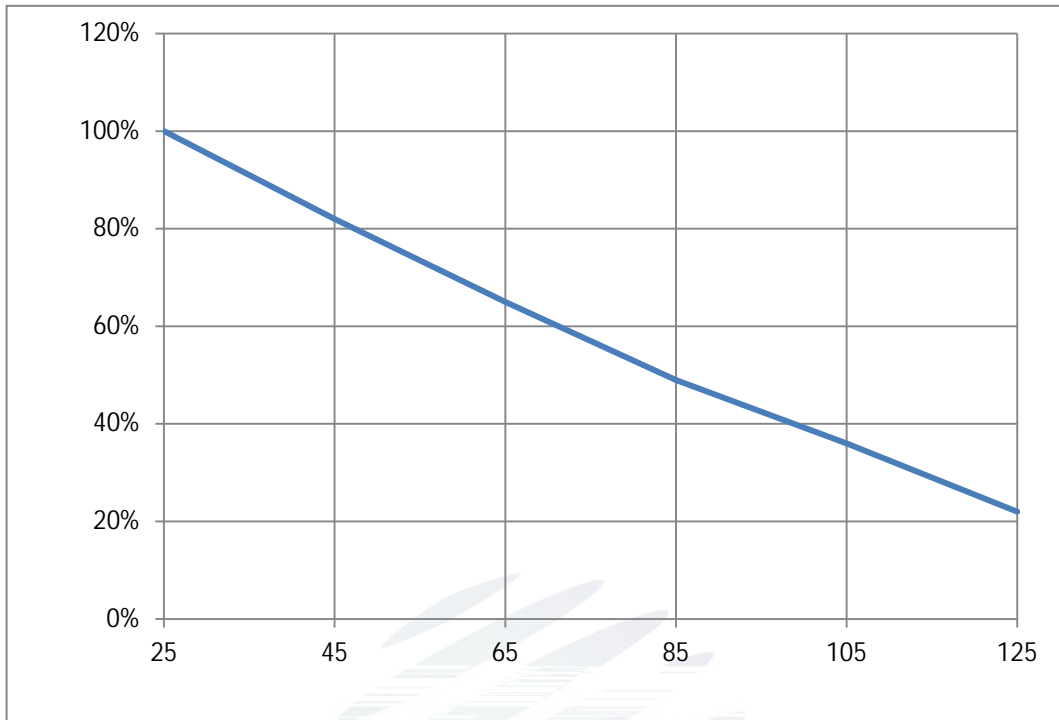

Fig. 1-9 Solder Temperature Vs Relative Intensity

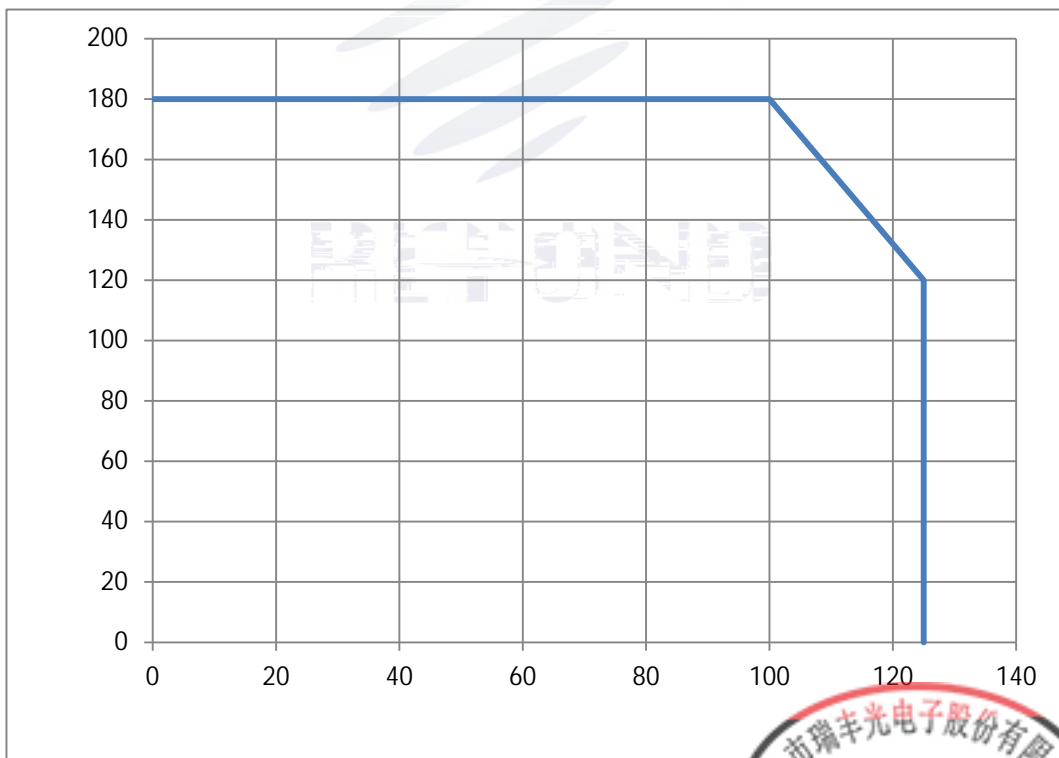

Fig. 1-10 Solder Temperature Vs Forward Current



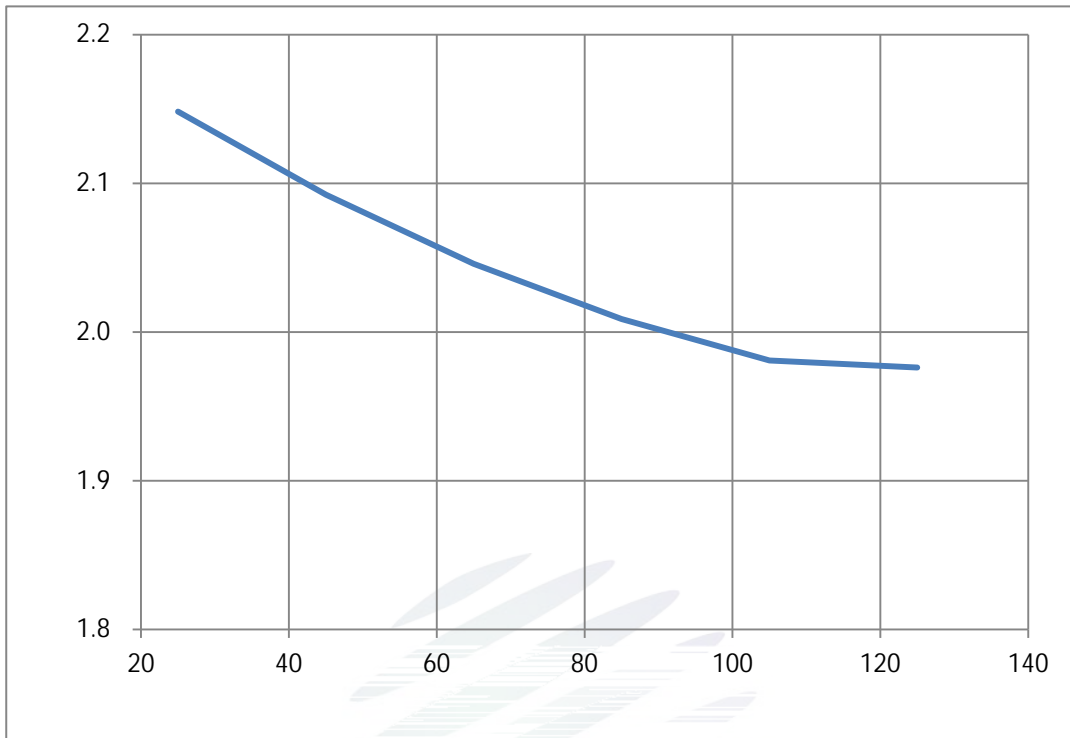

Fig. 1-11 Forward Voltage Vs Solder Temperature

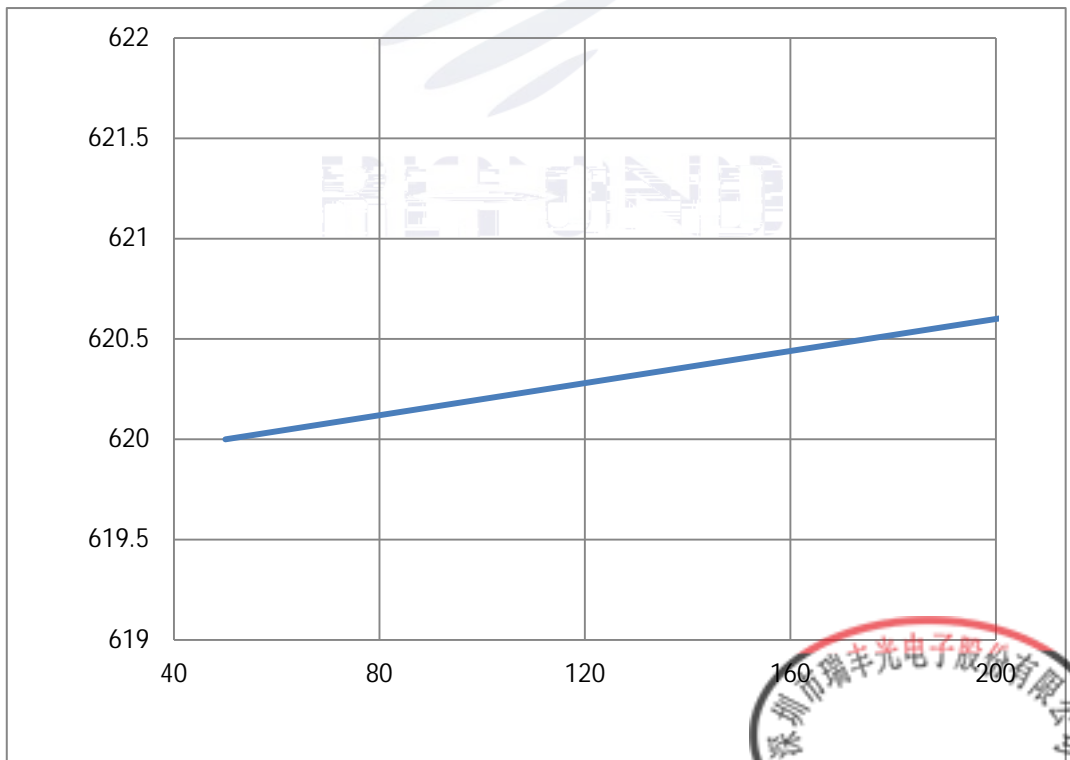
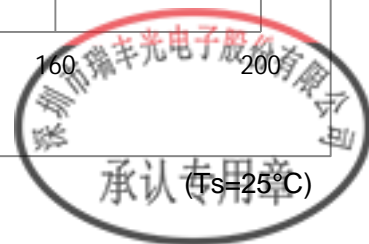

Fig. 1-12 Forward current vs. Color Shift



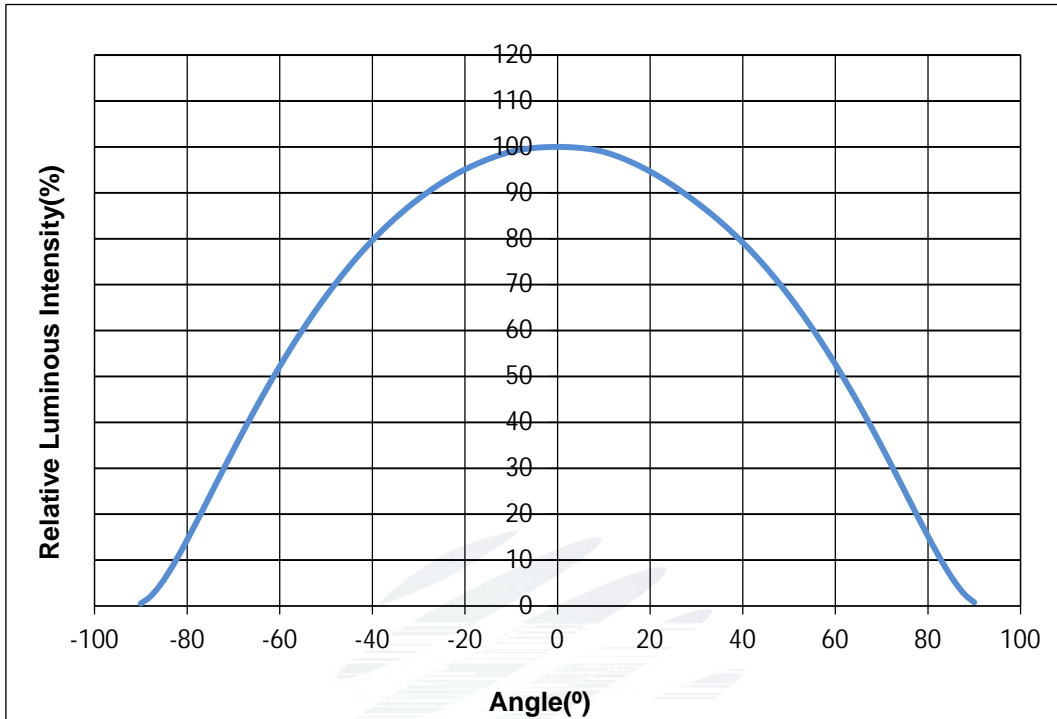

Fig. 1-13 Radiation diagram

Fig. 1-14 Spectrum Distribution

2. Packaging

2.1 Packaging Specification

Package:4000pcs/reel. 4000pcs

2.1.1 Carrier Tape Dimension

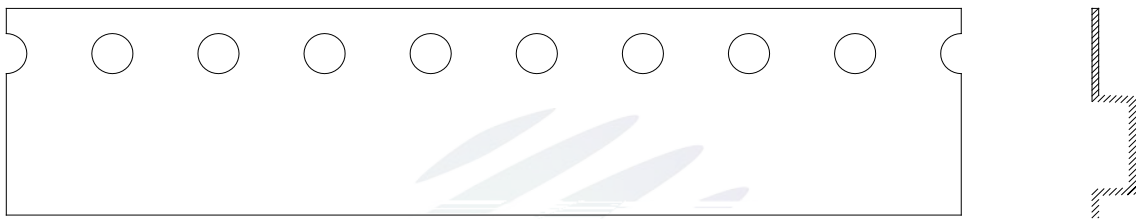

Fig.2-1 Carrier Tape Dimension

2.1.2 Reel Dimension

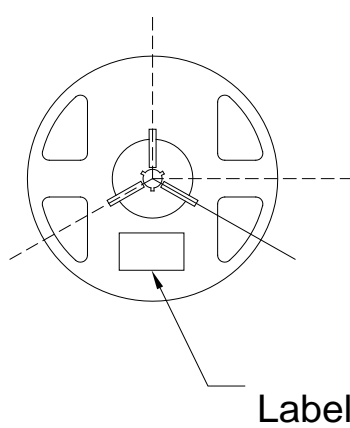

Fig.2-2 Reel Dimension

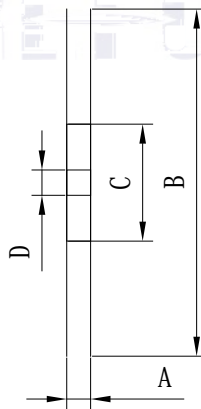

Table 2-1 Reel Dimension

A	12± 0.1mm
B	180± 1mm
C	60± 1mm
D	13.0± 0.5mm

Notes

The tolerances unless mentioned ± 0.1 mm. Unit : mm

± 0.1

2.1.3 Label Form Specification

Table 2-2 Specification

PART NO.	Part Number
SPEC NO.	Spec Number
LOT NO.	Lot Number
BIN CODE	Bin Code
	Luminous flux
XY	Chromaticity Bin
V _F	Forward Voltage
WLD	Wavelength
QTY	Packing Quantity
DATE	Made Date

Fig. 2-3 Label

2.2 Moisture Resistant Packing

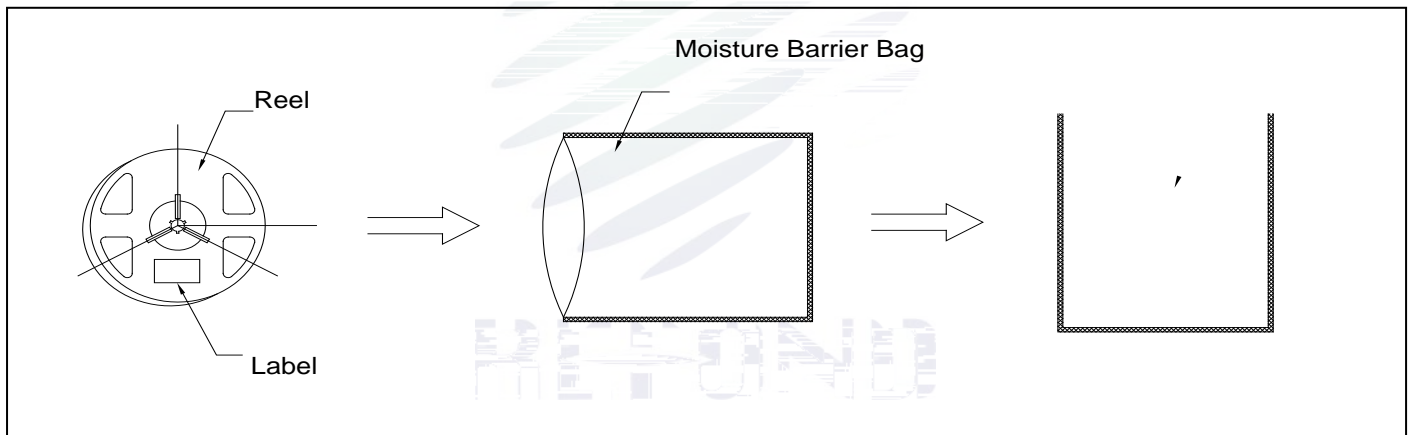

Fig.2-4 Moisture Resistant Packing

2.3 Cardboard Box



Fig.2-5 Cardboard Box

2.4 Reliability Test Items And Conditions

Table 2-3 Reliability Test Items And Conditions

Test Items	Ref.Standard	Test Condition	Time	Quantity	Ac/Re /
Reflow	JESD22-B106	Temp:260 max T=10 sec	2times	20pcs.	0/1
MSL2 2	JESD22-A113	85 / 60%RH	168 hrs.	20pcs.	0/1
Thermal Shock	JEITAED-4701 300307	-40 15min 10s 125 15min	1000 cycle	20pcs.	0/1
Life Test	JESD22-A108	Ta=105 If=150mA	1000hrs.	20pcs.	0/1
High Temperature High Humidity Life Test	JESD22-A101	85 / 85%RH If=150mA	1000hrs.	20pcs.	0/1



3. SMT Reflow Soldering Instructions SMT

3.1 SMT Reflow Soldering Instructions SMT

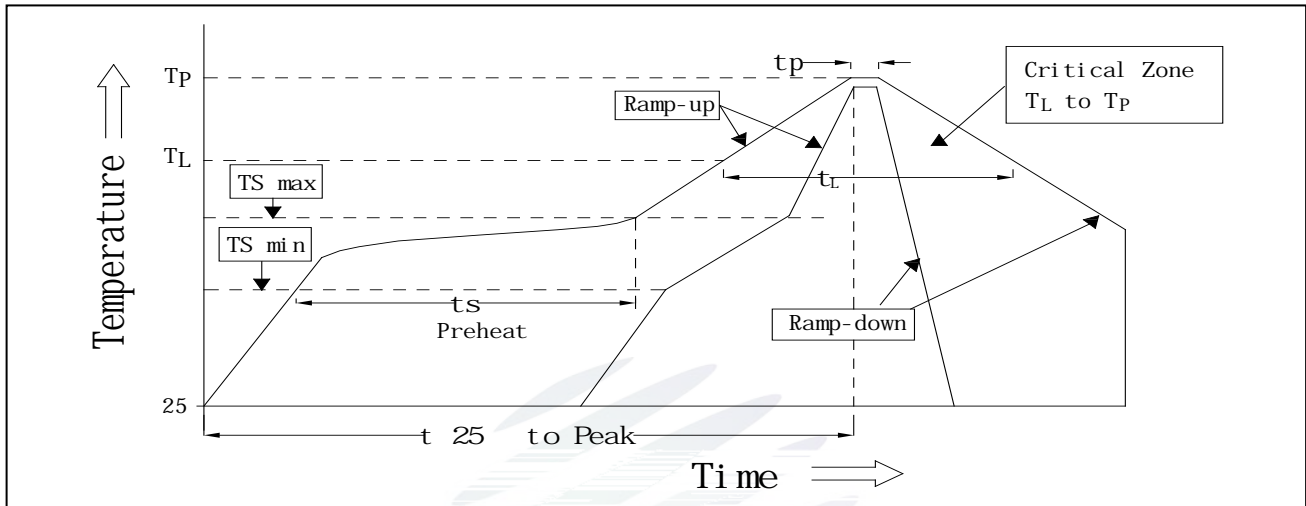
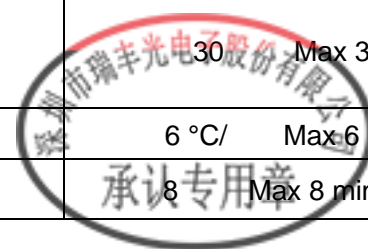

Fig.3-1SMT Reflow Soldering Instructions SMT

Table 3-1Reflow parameters

Average temperature rise speed	T_{smax} T_P	3 °C/ Max 3 °C/ s
Preheating: minimum temperature	(T_{smin})	150 °C
Preheating: Max temperature	(T_{smax})	200 °C
Preheating: Time	T_{smin} T_{smax}	60 - 120 60s-120s
Time limited to maintain high temperature: the temperature	(T_L)	217 °C
Time limited to maintain high temperature: The Time	(t_L)	60 Max 60s
Peak /Classification of temperature:	/ (T_P)	260 °C
Time limit classification of peak temperature time	t_p	10 Max 10s
Hold time within 5°Cwith the actual peak temperature (T_P)	(T_P) 5°C	30 Max 30s
Cooling speed		6 °C/ Max 6 °C/ s
Needed time from 25 °C to T_P	25°C	8 Max 8 minutes



Notes

(1)Reflow soldering should not be done more than twice. If more than 24 hours between the two solderings , LED will be damaged. 24 LED

(2)Whensoldering , do not put stress on the LEDs during heating.

3.1.1 Repairing

Repairing should not be done after the LEDs have been soldered. When repairing is unavoidable,a double-head soldering iron should be used (as below figure). It should be confirmed in advance whether the characteristics of LEDs will or not be damaged by repairing.

LED

LED

3.1.2 Cautions

(1) The encapsulated material of the LEDs is silicone. Therefore the LEDs have a soft surface on the top of package. The pressure to the top surface will be impacted on the reliability of the LEDs. Precautions should be taken to avoid the strong pressure on the encapsulated part. So when use the picking up nozzle, the pressure on the silicone resin should be proper. LED LED

(2) Components should not be mounted on warped (non coplanar) portion of PCB. After soldering, do not warp the circuit board.LED PCB

(3) Do not apply mechanical force or excess vibration during the cooling process to normal temperature after soldering. Do not rapidly cool device after soldering.



4. Handling Precautions

4.1 Handling Precautions

(1) LED operating environment and sulfur element composition cannot be over 100PPM in the LED mating usage material. This is provided for informational purposes only and is not a warranty or endorsement.

LED 100PPM

(2) In order to prevent external material from getting into the inside of LED, which may cause the malfunction of LED, the single content of Bromine element is required to be less than 900PPM, the single content of Chlorine element is required to be less than 900PPM, the total content of Bromine element and Chlorine element in the external materials of the application products is required to be less than 1500PPM. This is provided for informational purposes only and is not a warranty or endorsement.

LED 900PPM LED 900PPM
1500PPM

(3) VOCs (Volatile organic compounds) emitted from materials used in the construction of fixtures can penetrate silicone encapsulants of LEDs and discolor when exposed to heat and photonic energy. The result can be a significant loss of light output from the fixture. Knowledge of the properties of the materials selected to be used in the construction of fixtures can help prevent these issues. Refond advises against the use of any chemicals or materials that have been found or are suspected to have an adverse effect on device performance or reliability. To verify compatibility, Refond recommends that all chemicals and materials be tested in the specific application and environment for which they are intended to be used. Attaching LEDs, do not use adhesives that outgas organic vapor.

LED LED

LED

(4) Handle the component along the side surface by using forceps or appropriate tools. Do not directly touch or handle the silicone lens surface, it may damage the internal circuitry.



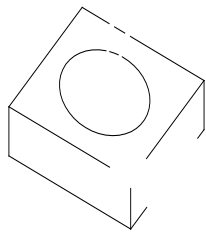

Fig 4-1 Handling Precautions

(5) In designing a circuit, the current through each LED can not exceed the absolute maximum rating specified for each LED. In the meanwhile, resistors for protection should be applied, otherwise slight voltage shift will cause big current change, burn out may happen. The driving circuit must be designed to allow forward voltage only when it is ON or OFF. If the reverse voltage is applied to LED, migration can be generated resulting in LED damage.

LED

LED

(6) Thermal Design is paramount importance because heat generation may result in the Characteristics decline, such as brightness decreased, Color change and so on. Please consider the heat generation of the LEDs when making the system design.

LED

(7) Compared to standard encapsulants, silicone is generally softer, and the surface is more likely to attract dust, requiring special care during processing. In cases where a minimal level of dirt and dust particles cannot be guaranteed, a suitable cleaning solution must be applied to the surface after the soldering of components. Refond suggests using isopropyl alcohol for cleaning. In case other solvents are used, it must be assured that these solvents do not dissolve the package or resin. Ultrasonic cleaning is not recommended. Ultrasonic cleaning may cause damage to the LED.

LED



Table 4-1 Storage

Conditions		Temperature	Humidity	Time
Storage	Before Opening Aluminum Bag	30	75%	Within 1 Year From Date
	After Opening Aluminum Bag	30	60%	Recommended for use within 24 hours 24
Baking		60± 5	-	24hours 24

(8) If the moisture absorbent material silica gel has faded away or the LEDs have exceeded the storage time, baking treatment should be performed after unpacking and based on the following condition 60 ± 5 for above 24 hours.

60± 5 24

If the package is flatulence or damaged, please notify the sales staff to assist.

(9) Similar to most Solid state devices; LEDs are sensitive to Electro-Static Discharge (ESD) and Electrical Over Stress (EOS). LED

(10) Other points for attention, please refer to our relevant information.



Version History/

Date	Revisor	Version	Verifier	Remarks
2022/05/10	Xian Zhou	E0	Zhu Yiming	New issue
2023/04/10	Xian Zhou	E1	Zhu Yiming	Add optical center
				



Declare

This specification is written both in English and in Chinese and the latter is formal.