

# SPECIFICATION

REFOND P/N

RF-A2A31-H40C-H4

Mass Production



## Contents

1.1 General Description	3
1.2 Features	3
1.3 Application	3
1.4 Package Dimension	4
1.5 Product Parameters	5
1.6 Bin Range Of Forward Voltage and Luminous Intensity and Dominant wavelength (IF=100mA)	
BIN (IF=100mA)	6
1.7 Typical Optical Characteristics Curves	
2.1 Packaging Specification	
2.1.1 Carrier Tape Dimension	11
2.1.2 Reel Dimension	11
2.1.3 Label Form Specification	12
2.2 Moisture Resistant Packing	
2.3 Cardboard Box	
2.4 Reliability Test Items And Conditions	
2.5 Criteria For Judging Damage	
3.1 SMT Reflow Soldering Instructions SMT	
4.1 Handling Precautions	



# 1 Description

## 1.1 General Description

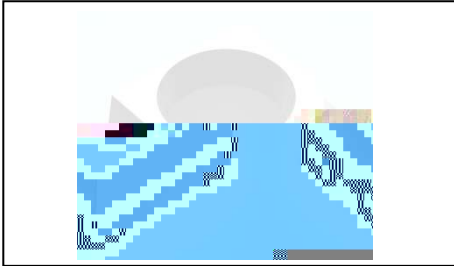

The IR source color devices are made with AlGaAs on Substrate Light Emitting Diode  
The LED package dimension:3.5mmX2.8mmX1.85mm.

## 1.2 Features

PLCC4 Package.

Extremely wide viewing angle.

Suitable for all SMT assembly and solder process.

Available on tape and reel.

Moisture sensitivity level: Level 3.

Compliance with RoHS and REACH.

Qualifications: The product qualification test plan is based on the guidelines of AEC-Q102  
Stress Test Qualification for Automotive Grade Discrete Semiconductors

## 1.3 Application

Automotive Lighting Interior and Exterior.



## 1.4 Package Dimension

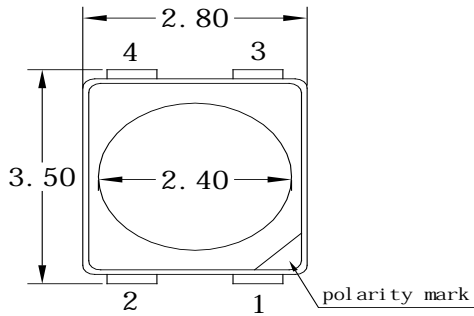

Fig. 1-1 Top View

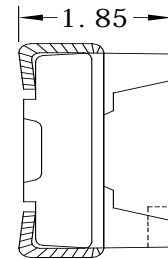

Fig. 1-2 Side View

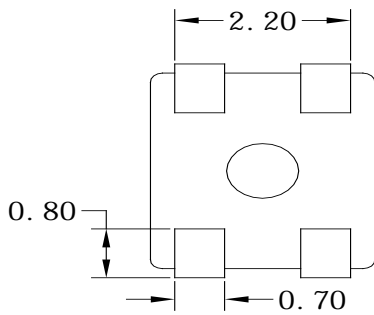

Fig. 1-3 Bottom View

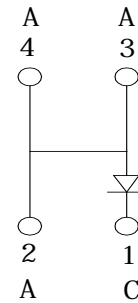

Fig. 1-4 Polarity

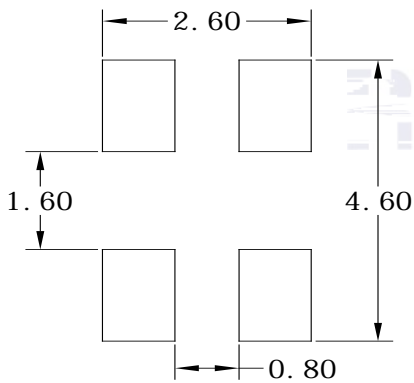

Fig. 1-5 Soldering Patterns

### Notes

All dimensions units are millimeters.

All dimensions tolerances are 0.2mm unless otherwise noted.



## 1.5 Product Parameters

Table 1-1 Electrical / Optical Characteristics at Ts=25°C

Item	Symbol	Test Condition	Value	Unit
------	--------	----------------	-------	------

Table 1-2 Absolute Maximum Ratings at Ts=25°C



Notes

1. 1/10 Duty cycle, 10ms pulse width.
2. The above forward voltage measurement allowance tolerance is  $\pm 0.1V$ .
3. The above color coordinates measurement allowance tolerance is  $\pm 0.005$ .  $\pm$
4. The above luminous intensity measurement allowance tolerance  $\pm 10\%$ .
5. Care is to be taken that power dissipation does not exceed the absolute maximum rating of the product.
6. All measurements were made under the standardized environment of Refond.
7. When the LEDs are in operation the maximum current should be decided after measuring the package temperature, junction temperature should not exceed the maximum rate
8. ESD yield is over 90% at 2000V ESD (HBM). ESD protection during products handing is needed.

**1.6 Bin Range Of Forward Voltage and Luminous Intensity and Dominant wavelength (IF=100mA)**

**BIN (IF=100mA)**

Table 1-3

VF V	0		
	1.2-1.8		
Ie mW/sr	L	M	N
	11.2-18	18-28.5	28.5-45
nm	F2	G1	G2
	930-940	940-950	950-960



## 1.7 Typical Optical Characteristics Curves

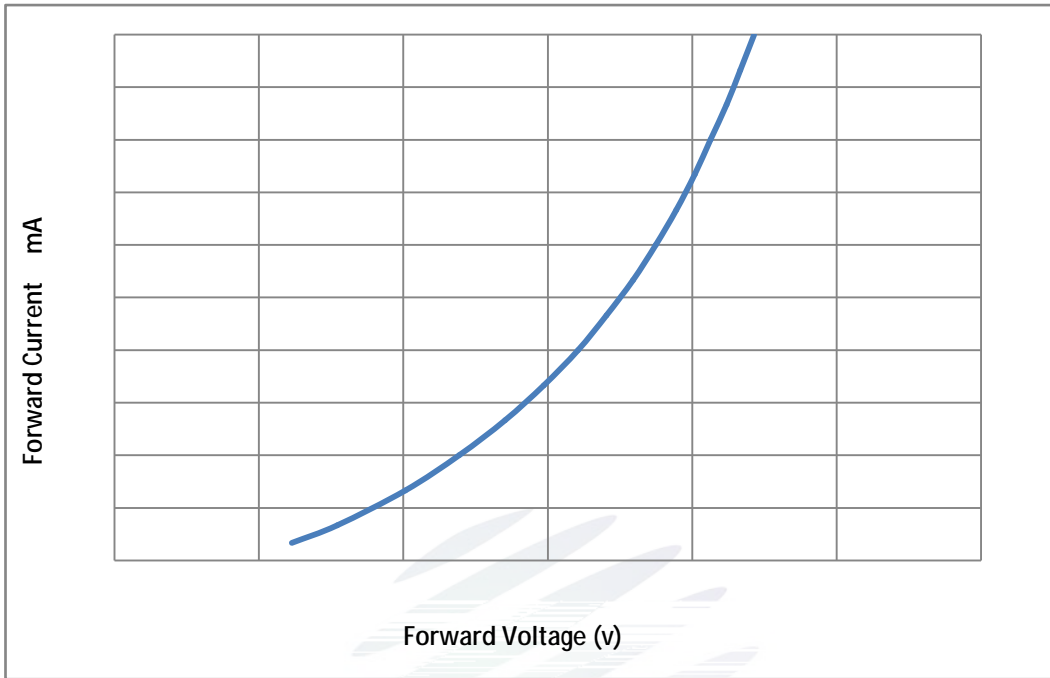

Fig. 1-7 Forward Voltage Vs Forward Current

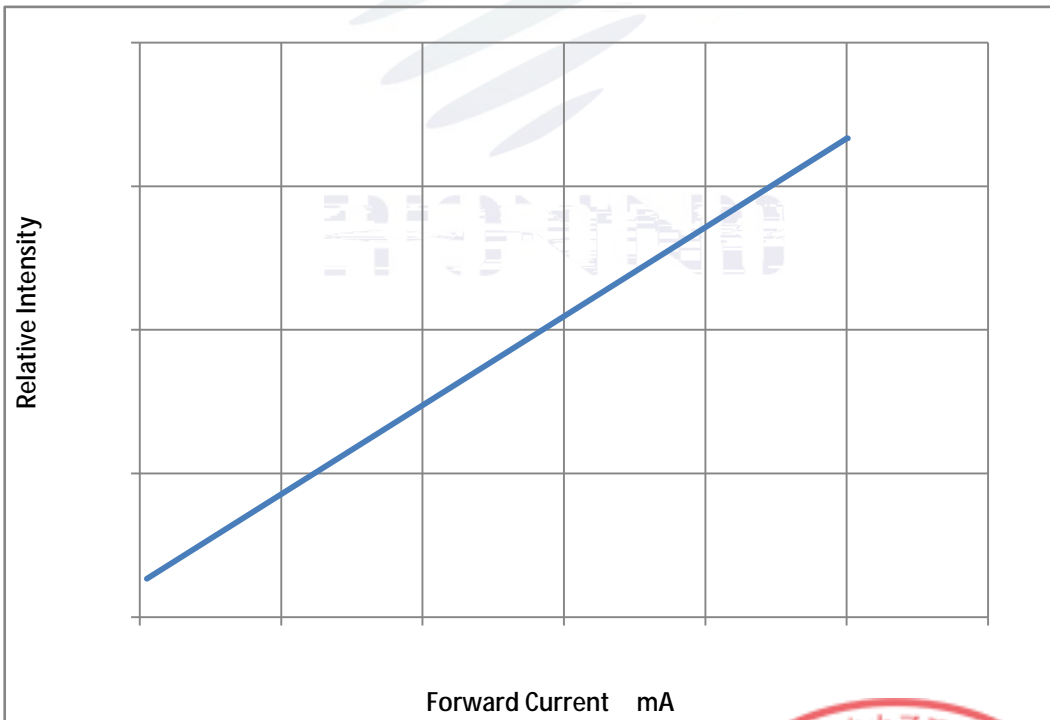

Fig. 1-8 Forward Current Vs Relative Intensity



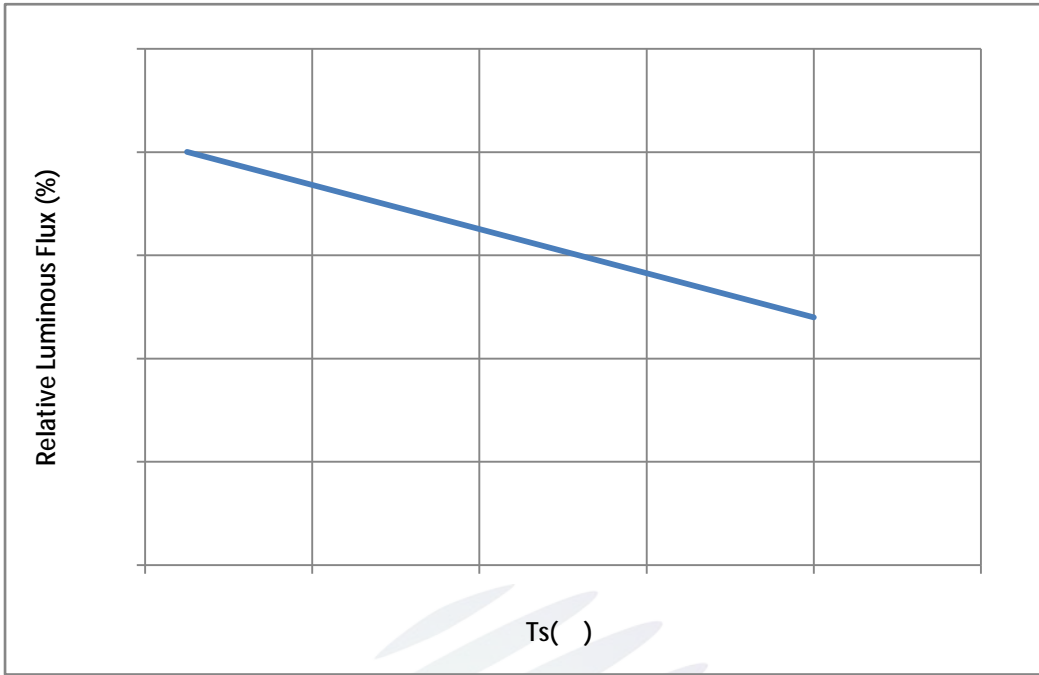

Fig. 1-9 Solder Temperature Vs Relative Intensity

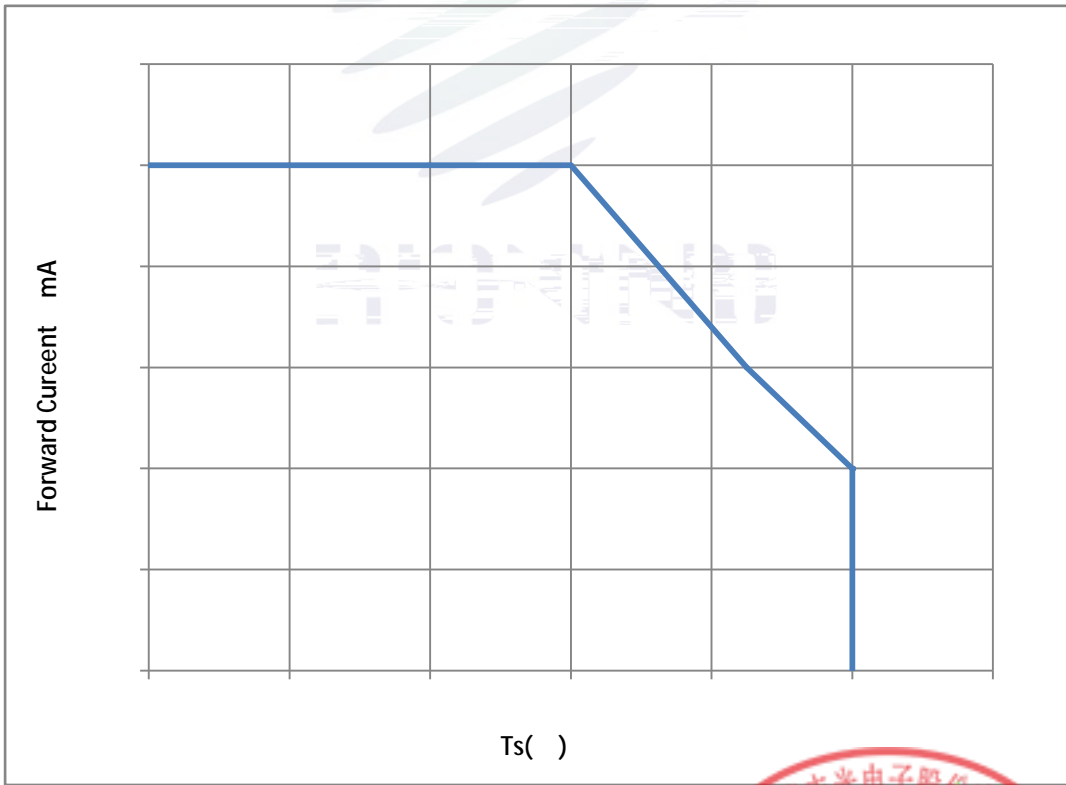

Fig. 1-10 Solder Temperature Vs Forward Current





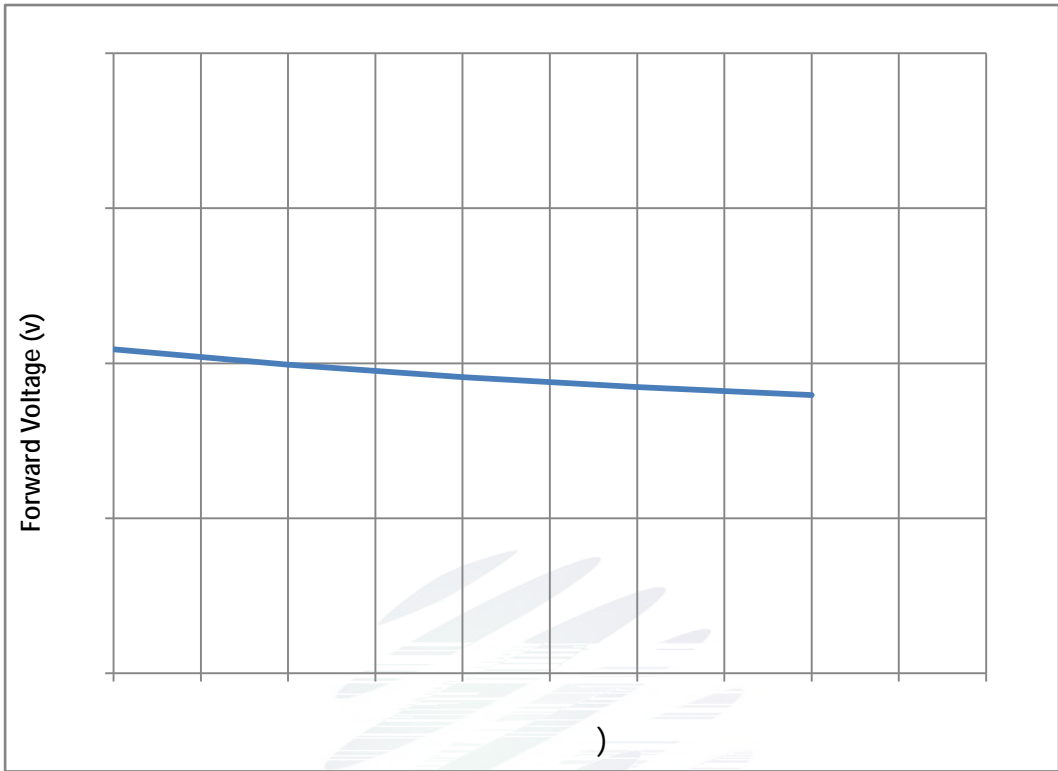

Fig. 1-11 Forward Voltage Vs Solder Temperature

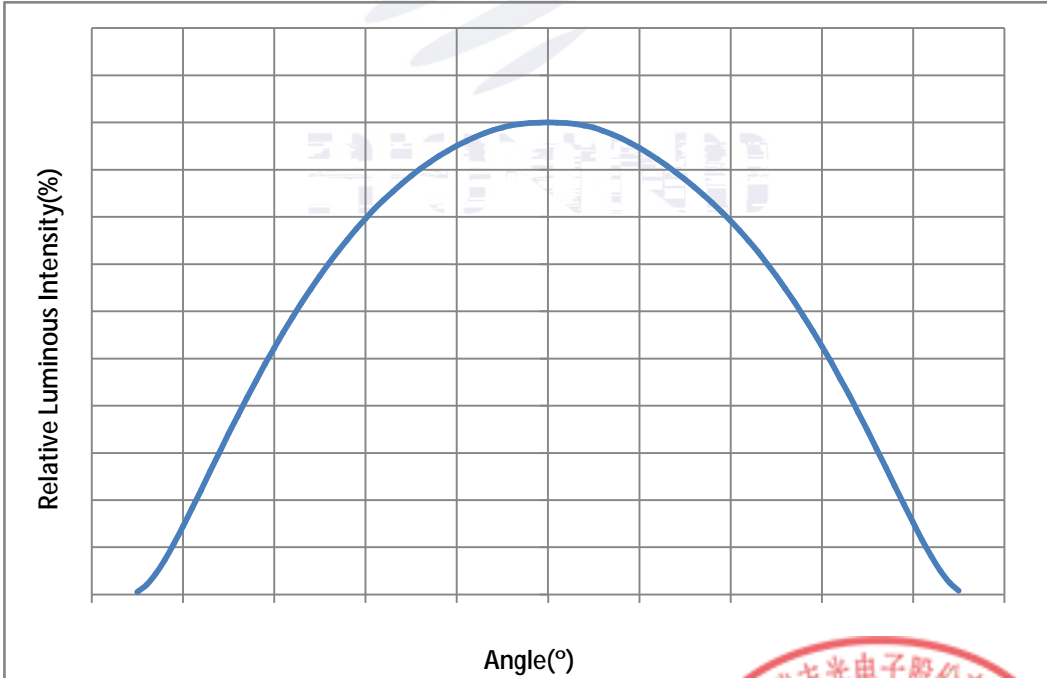

Fig. 1-12 Radiation diagram



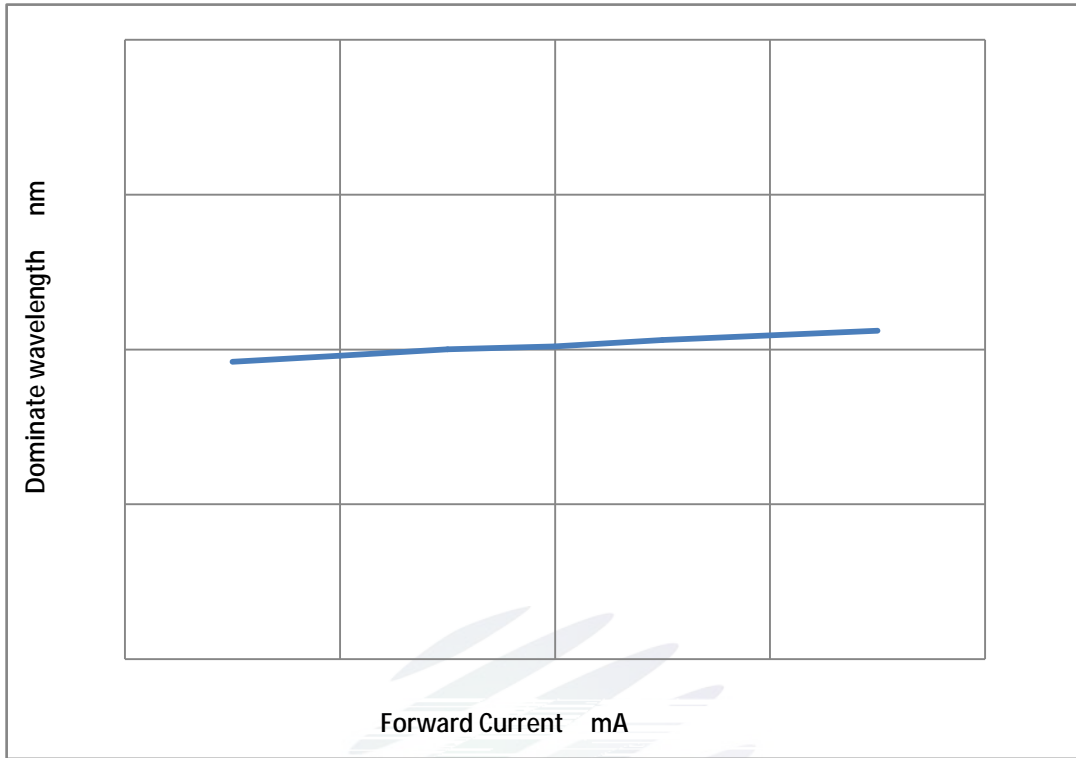

Fig. 1-13

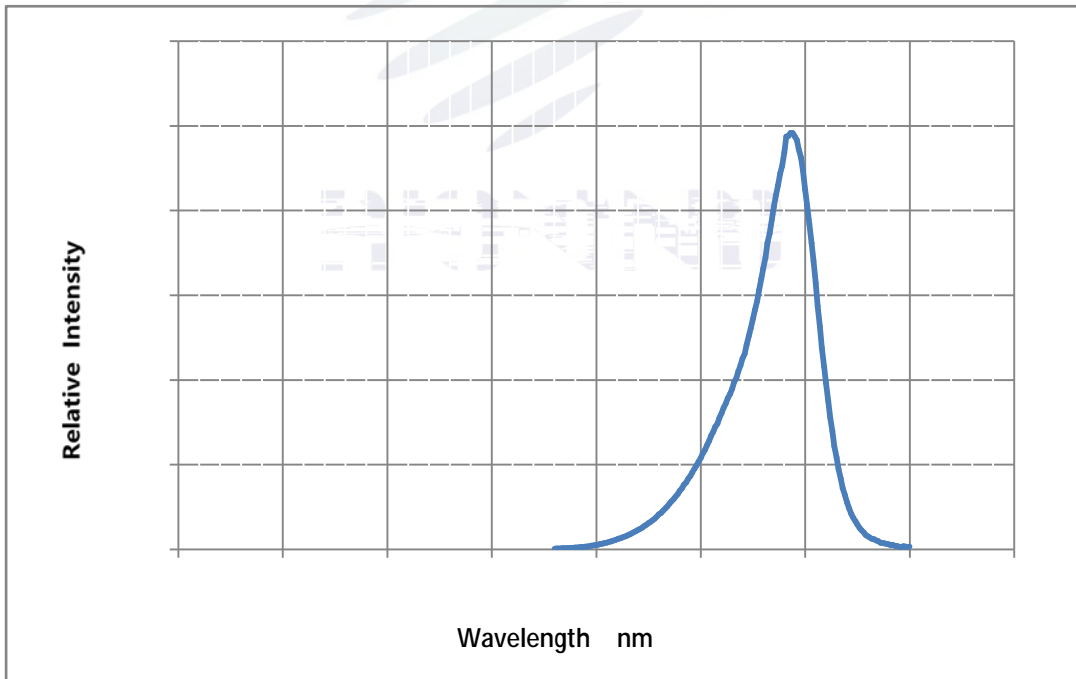

Fig. 1-14 Spectrum Distribution



## 2. Packaging

### 2.1 Packaging Specification

Package: 2000pcs/reel.      2000pcs

#### 2.1.1 Carrier Tape Dimension

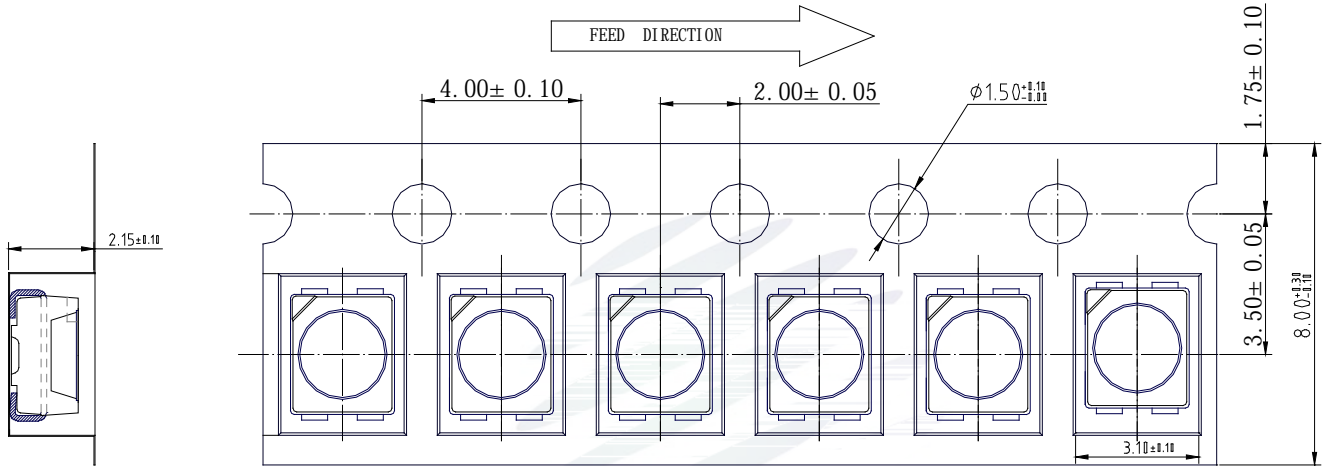

Fig.2-1 Carrier Tape Dimension

#### 2.1.2 Reel Dimension

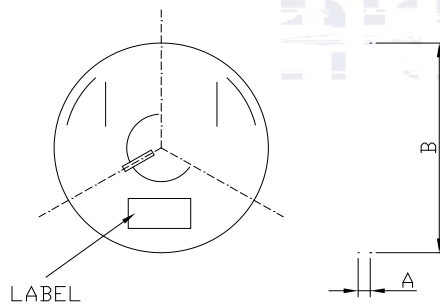

Fig.2-2 Reel Dimension

Reel Dimension

A	12.6 1mm
B	330 2mm
C	60 1mm
D	13.6 0.5mm

#### Notes

The tolerances unless mentioned  $\pm 0.1$ mm. Unit : mm

### 2.1.3 Label Form Specification

	Specification
PART NO.	Part Number
SPEC NO.	Spec Number
LOT NO.	Lot Number
BIN CODE	Bin Code
	Luminous flux
XY	Chromaticity Bin
$V_F$	Forward Voltage
WLD	Wavelength
QTY	Packing Quantity
DATE	Made Date

Fig. 2-3 Label Form Specification

### 2.2 Moisture Resistant Packing

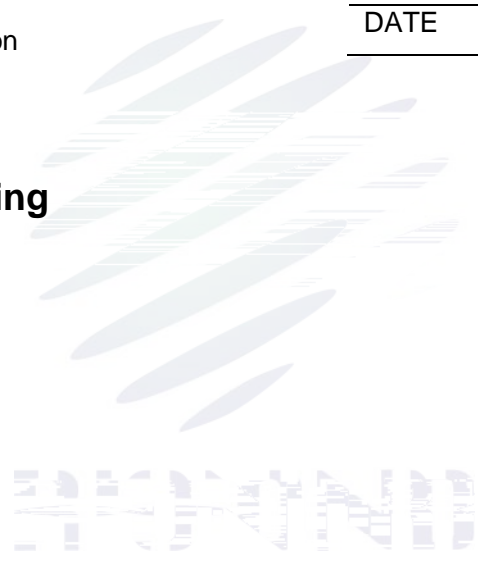

Fig.2-4 Moisture Resistant Packing

### 2.3 Cardboard Box

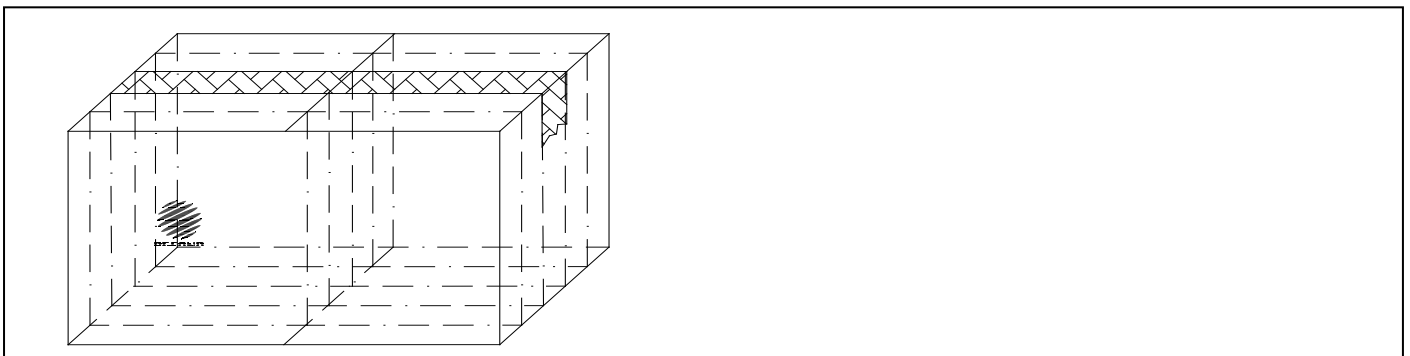

Fig.2-5 Cardboard Box





### 3.SMT Reflow Soldering Instructions SMT

#### 3.1SMT Reflow Soldering Instructions SMT

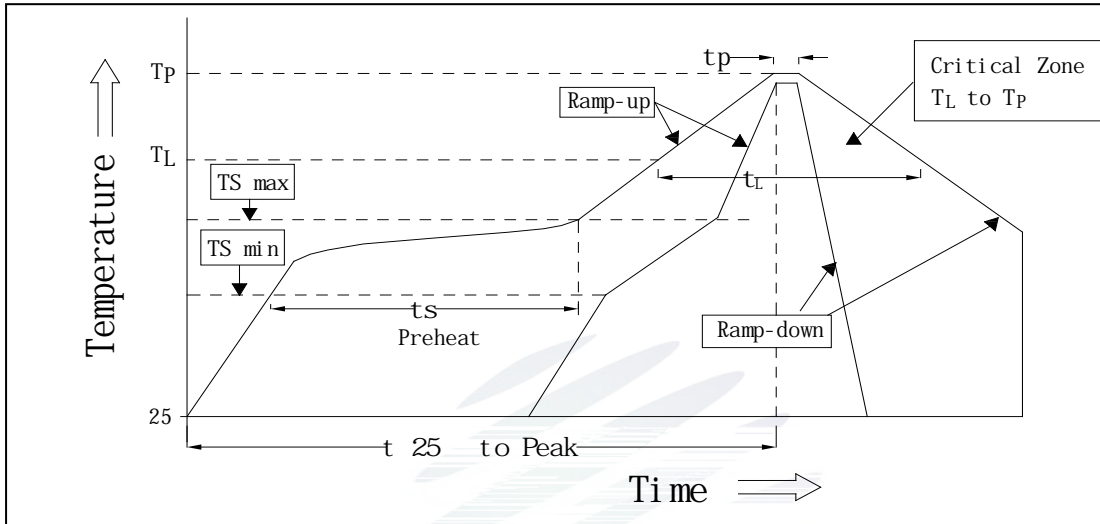

Fig.3-1SMT Reflow Soldering Instructions SMT

Table 3-1Reflow parameters

Average temperature rise speed	Tsmax	TP	3 °C/	Max 3 °C/ s
Preheating: minimum temperature	(Tsmi n)		150 °C	
Preheating: Max temperature	(Tsmax)		200 °C	
Preheating: Time	Tsmin	Tsmax	60 - 120	60s-120s
Time limited to maintain high temperature: the temperature		(TL)	217 °C	
Time limited to maintain high temperature: The Time		(tL)	60	Max 60s
Peak /Classification of temperature:	/	(TP)	260 °C	
Time limit classification of peak temperature time		tp	10	Max 10s
(TP)	5 °C	Hold time within 5 °C with the	30	Max 30s
actual peak temperature (TP)				
Cooling speed			6 °C/	Max 6 °C/ s
25 °C		Needed time from 25 °C to Tp	8	Max 8 minutes



## Notes

(1)Reflow soldering should not be done more than twice. If more than 24 hours between the two solderings , LED will be damaged.

(2)When soldering , do not put stress on the LEDs during heating.

### 3.1.1 Soldering Iron

(1) When do soldering by hand, keep the temperature of iron below less 300 less than 3 seconds.

(2) Soldering by hand should be done only one time.

### 3.1.2 Repairing

Repairing should not be done after the LEDs have been soldered. When repairing is unavoidable,a double-head soldering iron should be used (as below figure). It should be confirmed in advance whether the characteristics of LEDs will or not be damaged by repairing.

LED

### 3.1.3 Cautions

(1) The encapsulated material of the LEDs is silicone. Therefore the LEDs have a soft surface on the top of package. The pressure to the top surface will be impacted on the reliability of the LEDs. Precautions should be taken to avoid the strong pressure on the encapsulated part. So when use the picking up nozzle, the pressure on the silicone resin should be proper. LED

(2) Components should not be mounted on warped (non coplanar) portion of PCB. After soldering, do not warp the circuit board.LED

(3) Do not apply mechanical force or excess vibration during the cooling process to normal temperature after soldering. Do not rapidly cool device after soldering.





## 4. Handling Precautions

### 4.1 Handling Precautions

(1) LED operating environment and sulfur element composition cannot be over 100PPM in the LED mating usage material. This is provided for informational purposes only and is not a warranty or endorsement. LED

(2) In order to prevent ex-ternal material from getting into the inside of LED, which may cause the malfunction of LED, the single content of Bromine element is required to be less than 900PPM, the single content of Chlorine element is required to be less than 900PPM, the total content of Bromine element and Chlorine element in the external materials of the application products is required to be less than 1500PPM. This is provided for informational purposes only and is not a warranty or endorsement.

(3) VOCs (Volatile organic compounds) emitted from materials used in the construction of fixtures can penetrate silicone encapsulants of LEDs and discolor when exposed to heat and photonic energy. The result can be a significant loss of light output from the fixture. Knowledge of the properties of the materials selected to be used in the construction of fixtures can help prevent these issues. Refond advises against the use of any chemicals or materials that have been found or are suspected to have an adverse affect on device performance or reliability. To verify compatibility, Refond recommends that all chemicals and materials be tested in the specific application and environment for which they are intended to be used. Attaching LEDs, do not use adhesives that outgas organic vapor.

(4) Handle the component along the side surface by using forceps or appropriate tools; Do not directly touch or Handle the silicone lens surface, it may damage the internal circuitry.







Date	Revisor	Version	Verifier	Remarks
2022/08/20	Lu Xian	E0	Zhu Yiming	New issue

REFOND





Declare

This specification is written both in English and in Chinese and the latter is formal

