

..... 3

..... 3

..... 3

..... 3

..... 4

..... 5

..... 7

..... 11

..... 11

..... 11

..... 11

..... 12

..... 12

..... 13

..... 13

..... 14

..... 15

..... 15

..... 17

..... 17

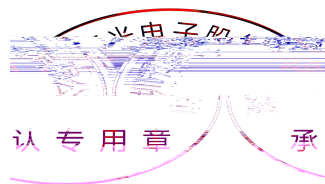

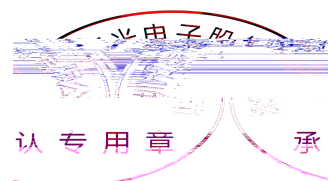
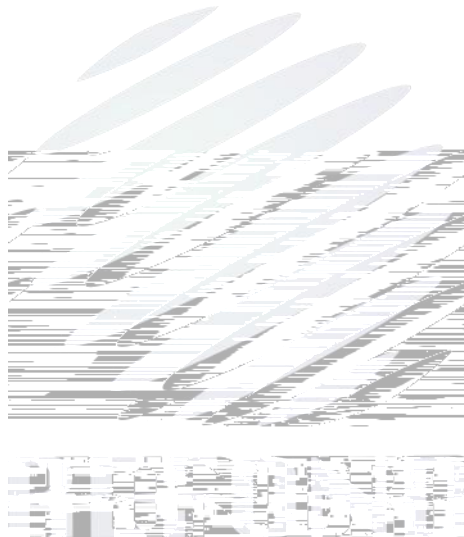
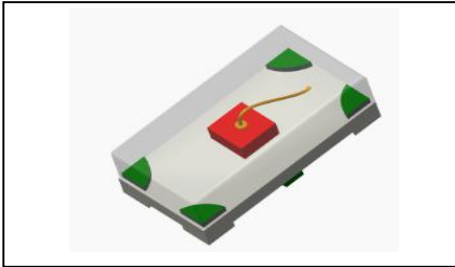

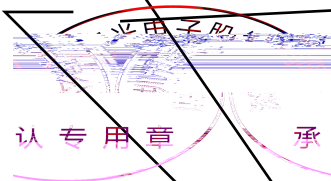
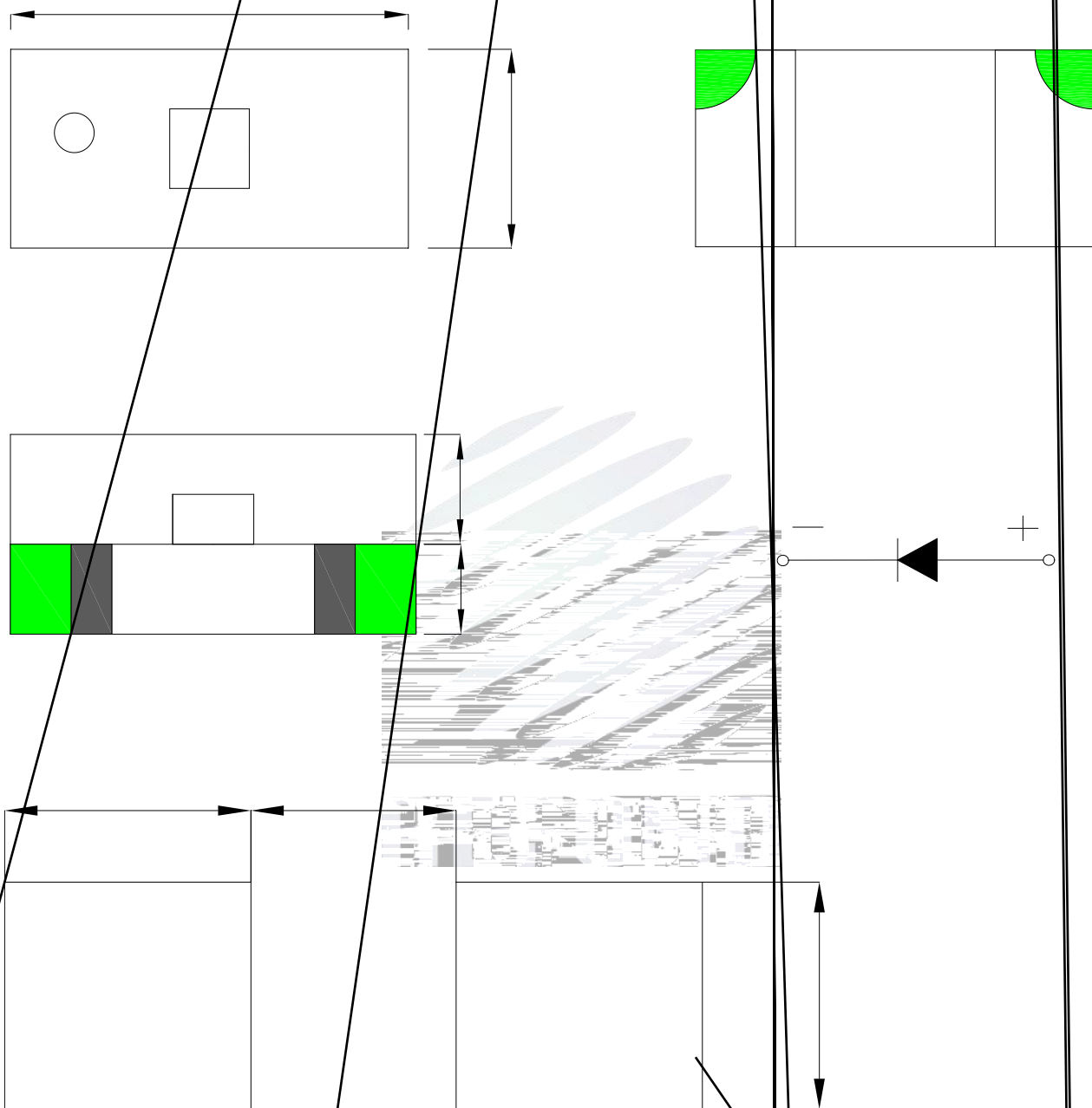



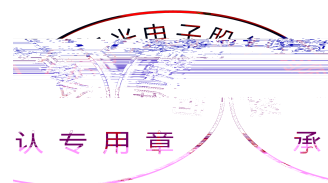
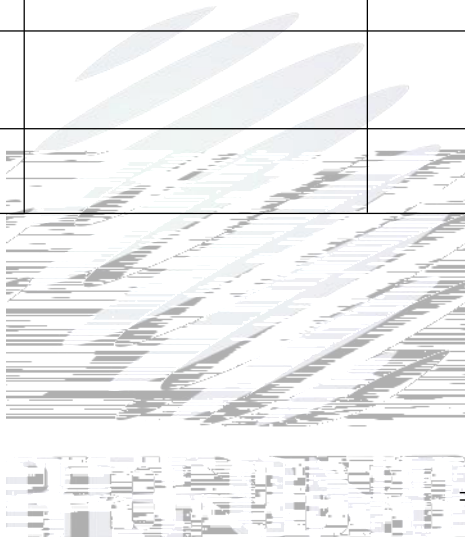

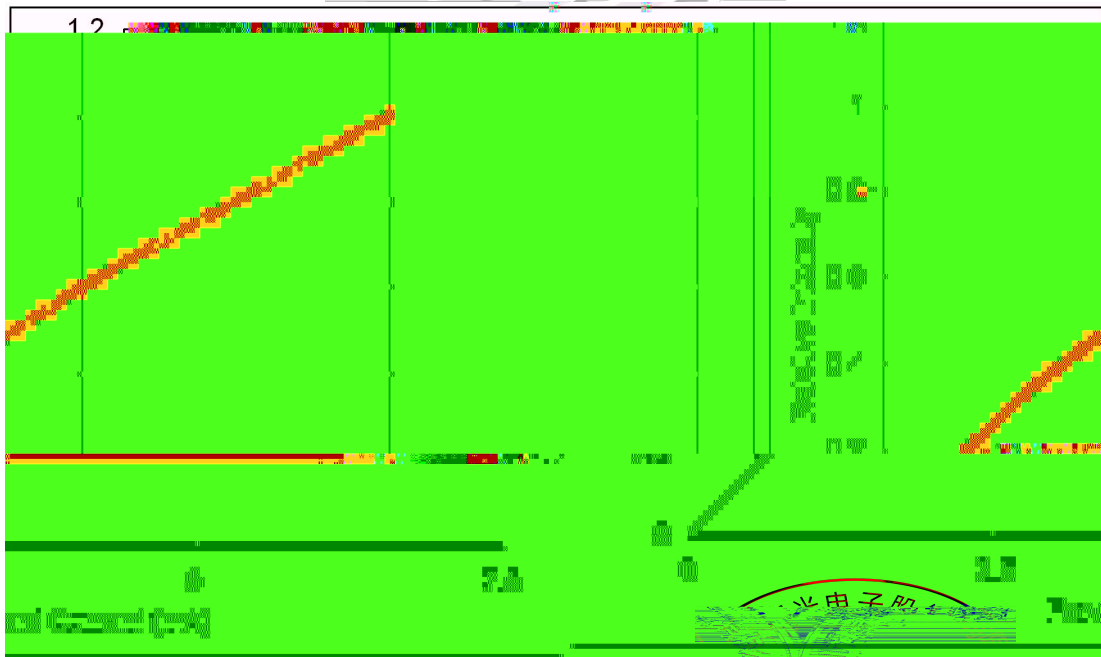
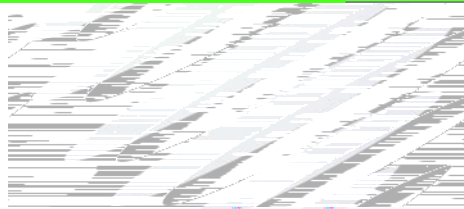
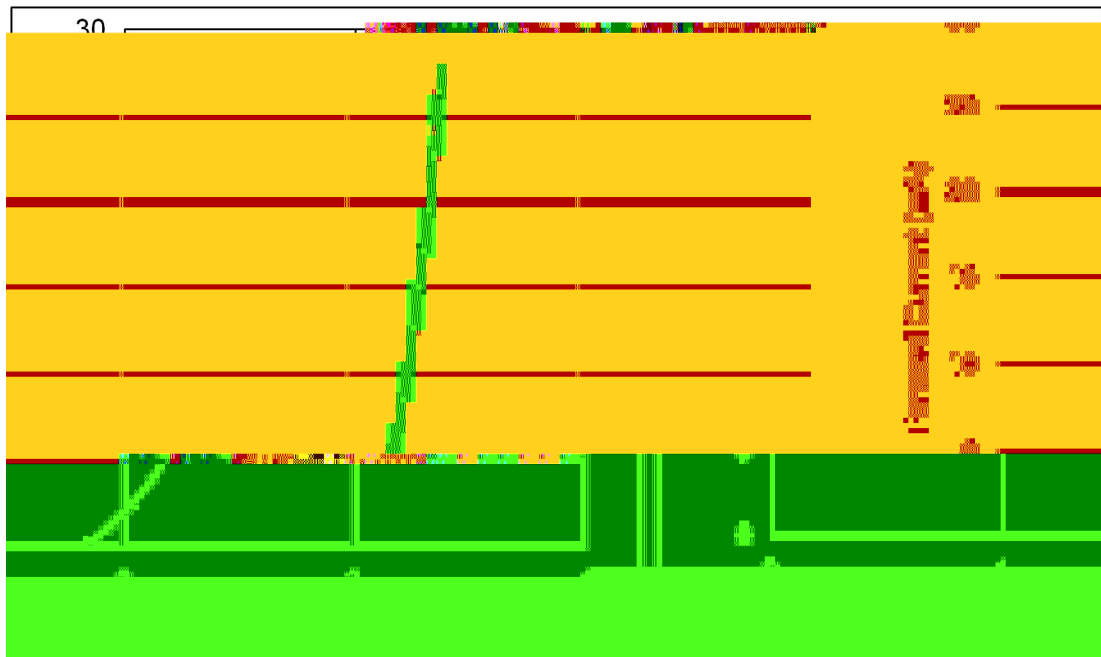

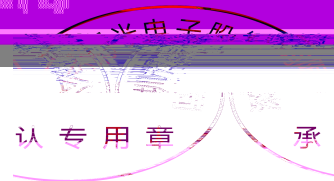
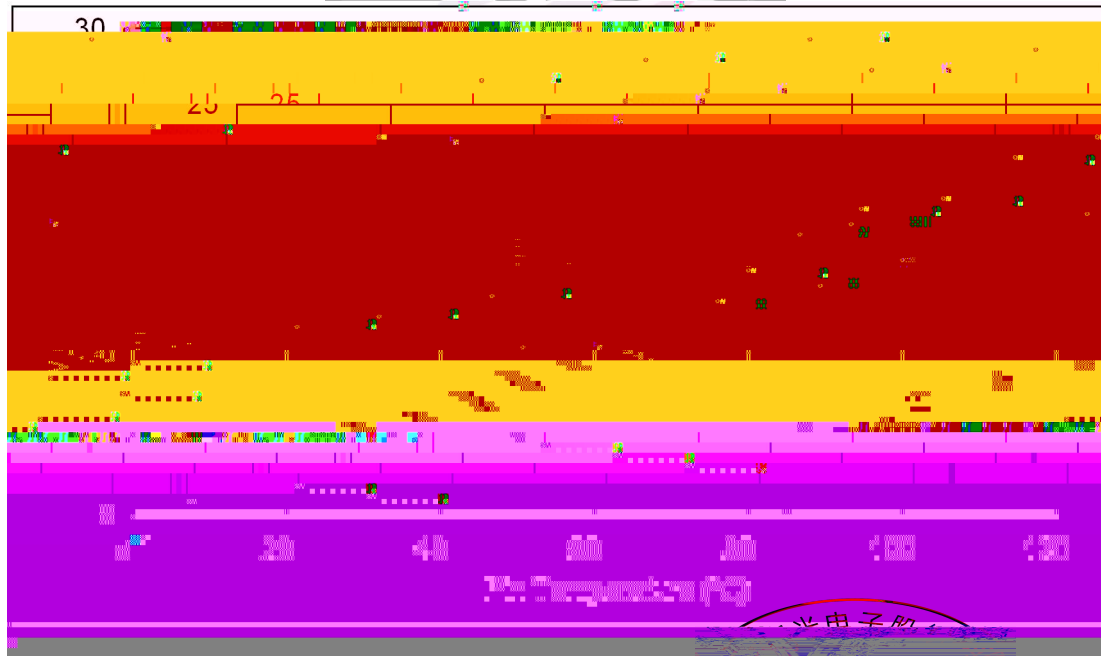
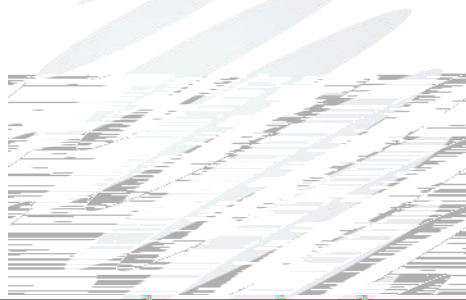
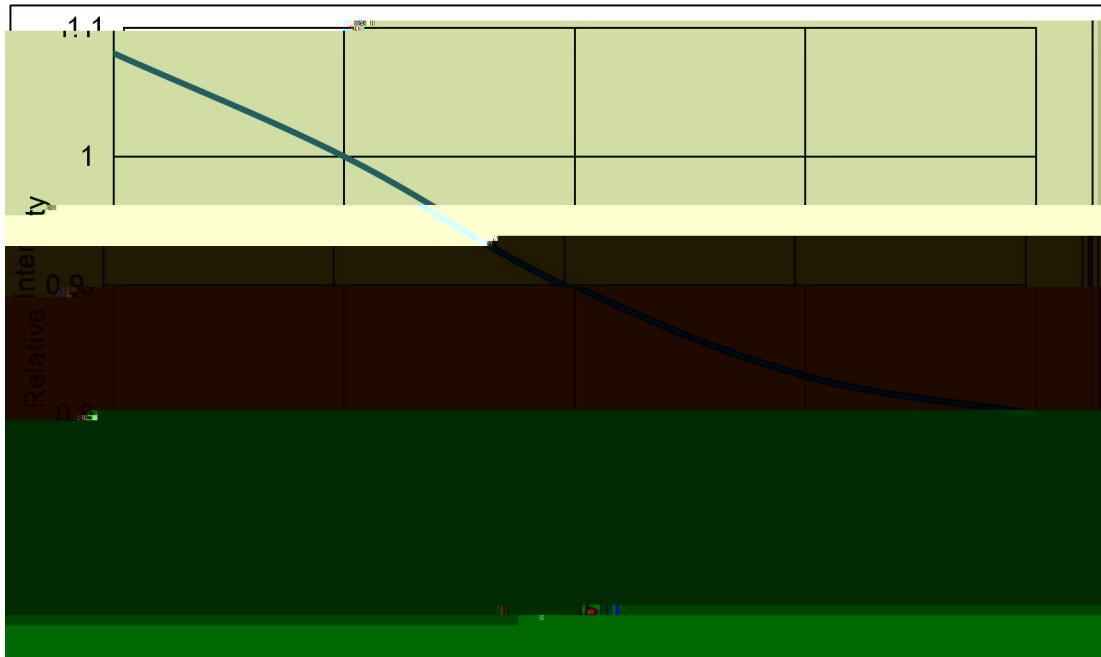

認專用章 承



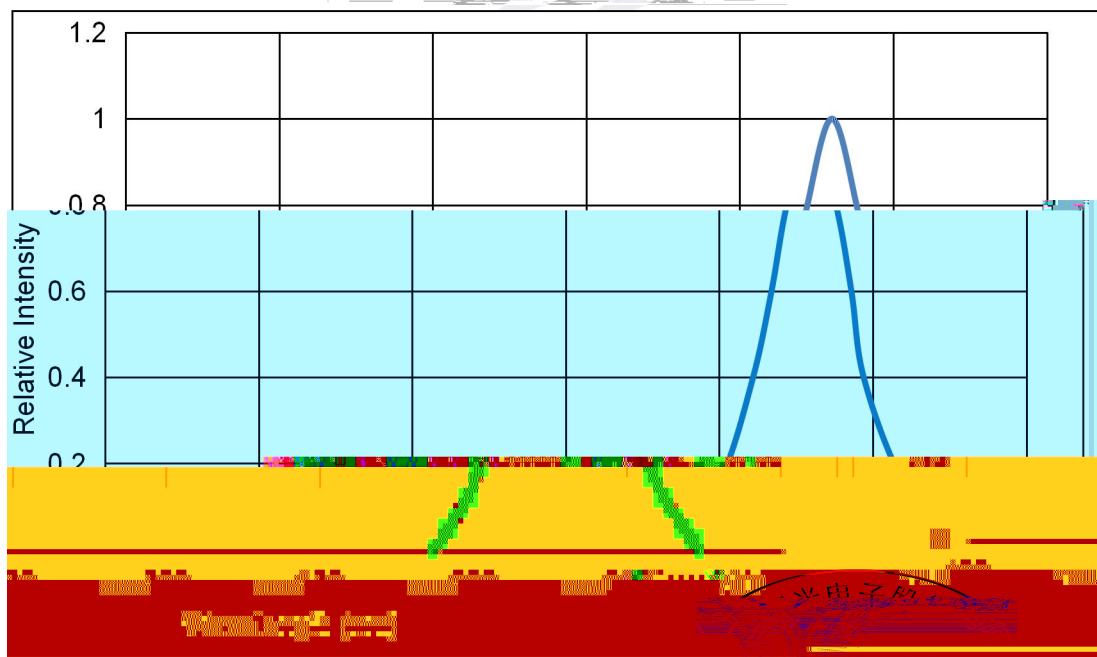
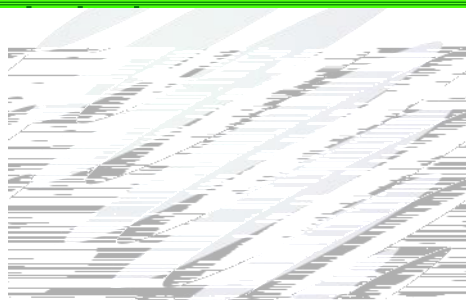
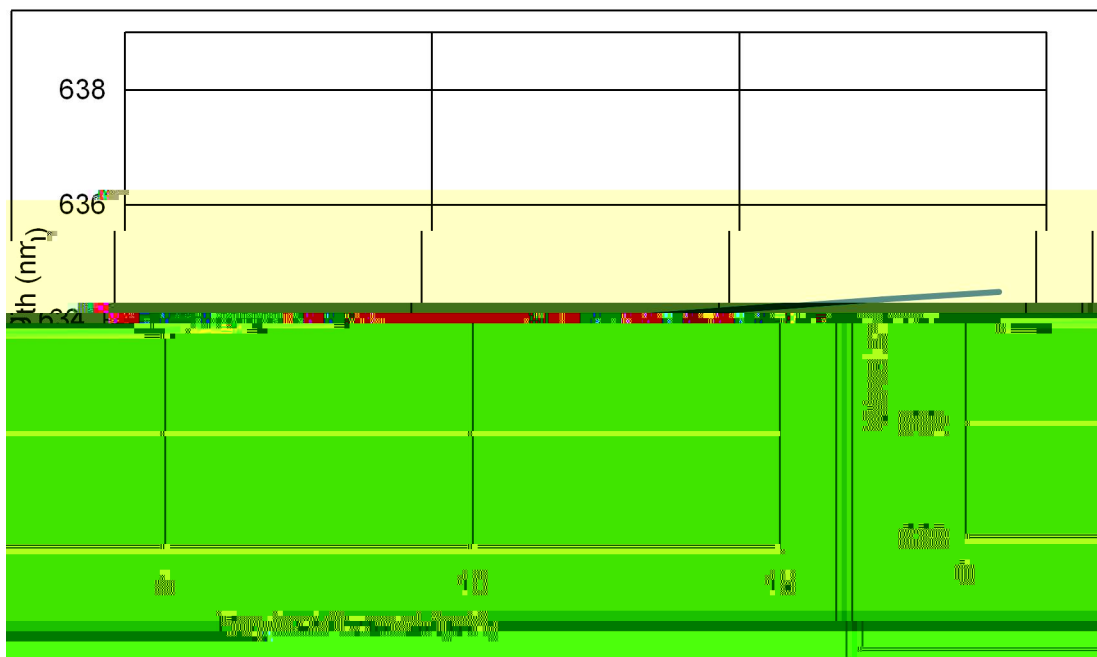



認專用章 承

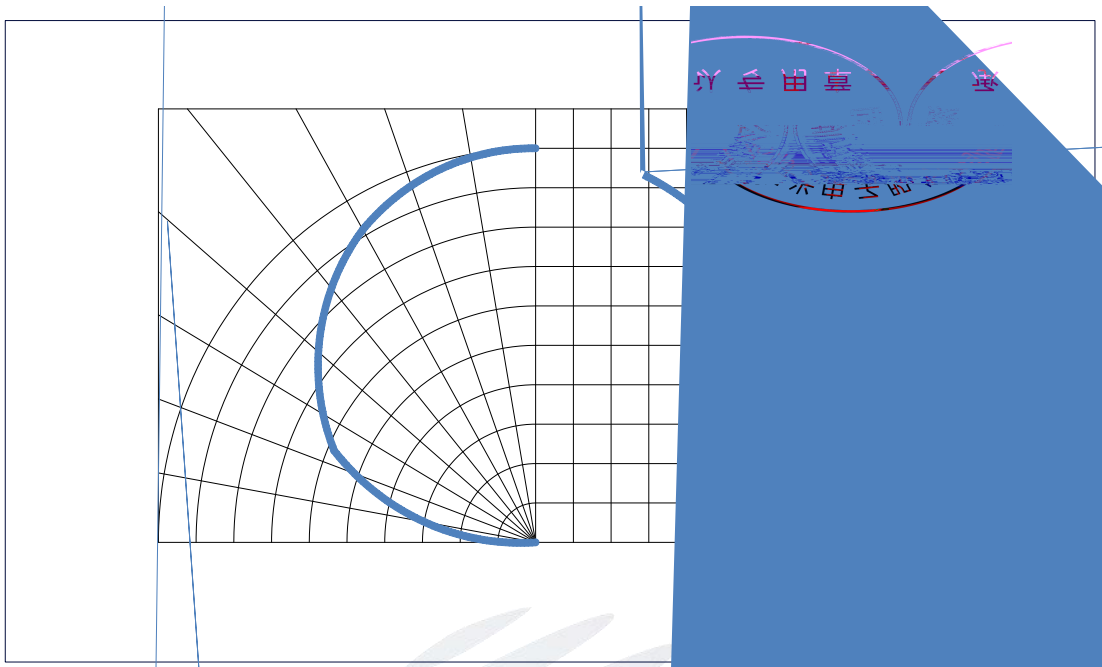

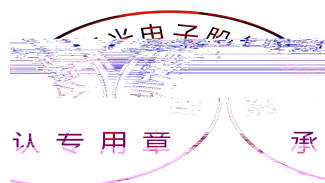
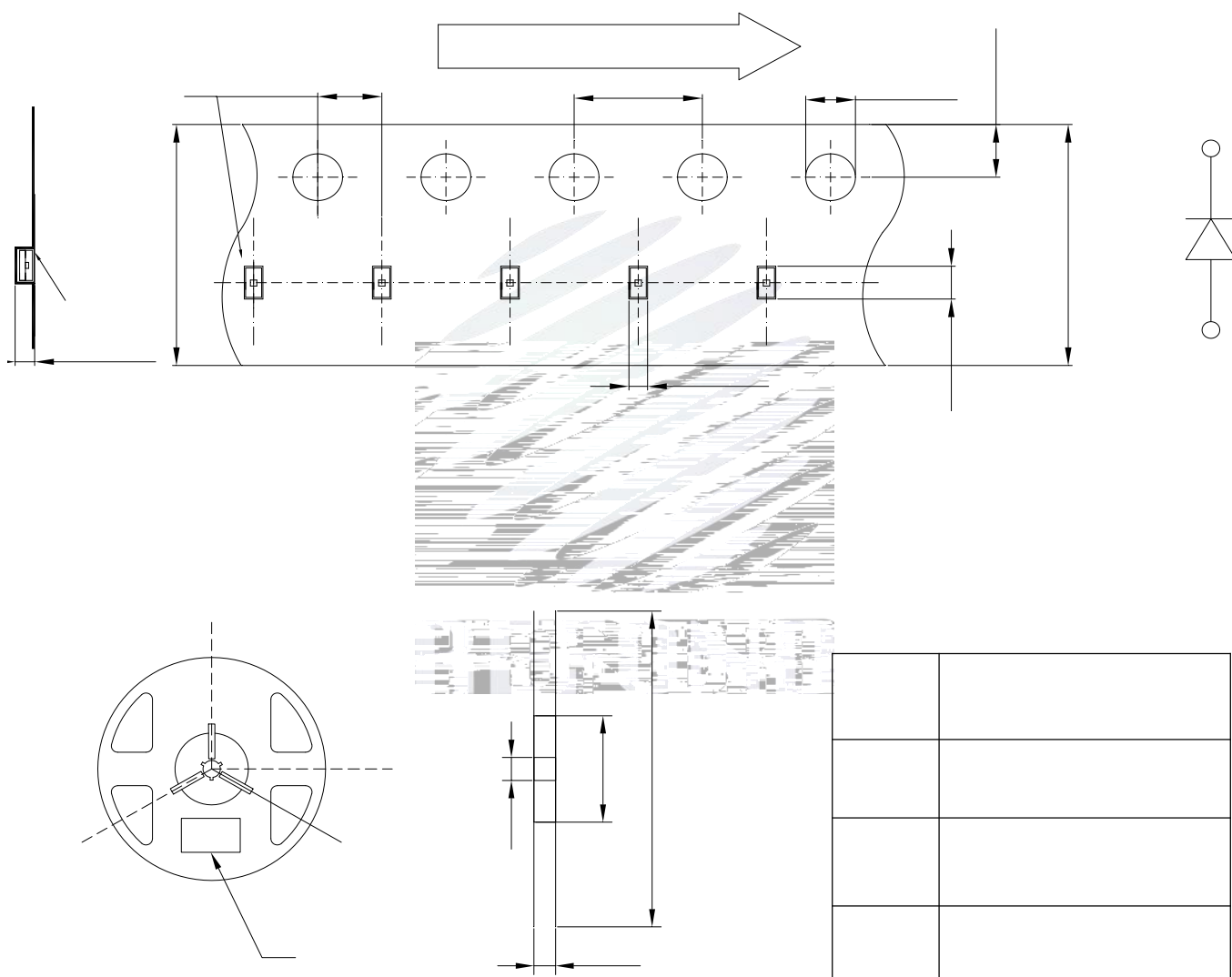

PART NO: \_\_\_\_\_  
 SPEC NO: \_\_\_\_\_  
 LOT NO: \_\_\_\_\_

BIN CODE: \_\_\_\_\_  
 Φ: \_\_\_\_\_ XY: \_\_\_\_\_  
 VF: \_\_\_\_\_ WLD: \_\_\_\_\_

QTY: \_\_\_\_\_  
 DATE: \_\_\_\_\_

\_\_\_\_\_

\_\_\_\_\_

\_\_\_\_\_

\_\_\_\_\_

\_\_\_\_\_

\_\_\_\_\_

\_\_\_\_\_

\_\_\_\_\_

