

L

DO

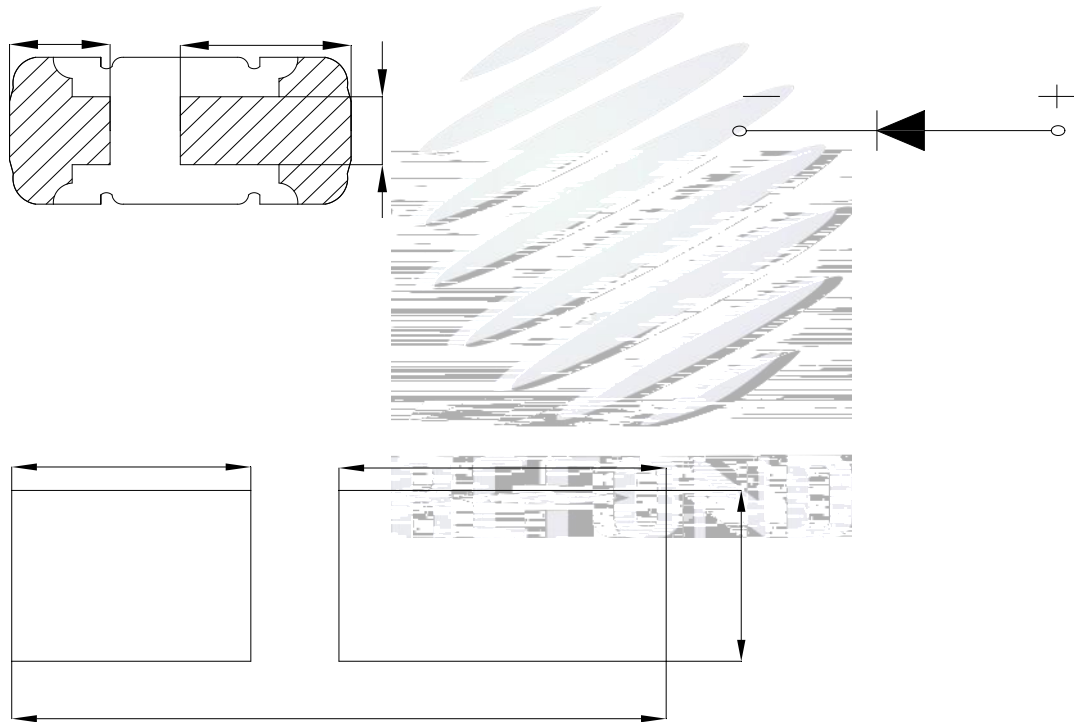

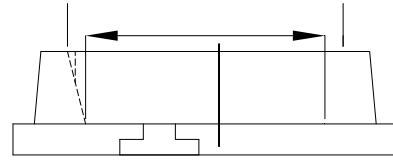

±





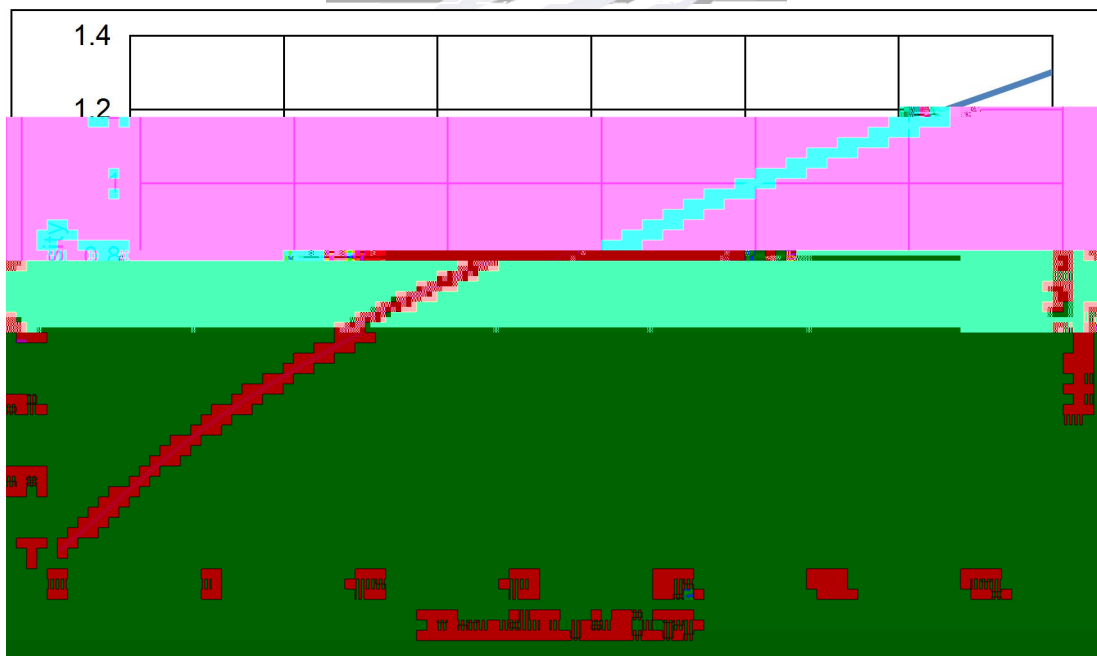
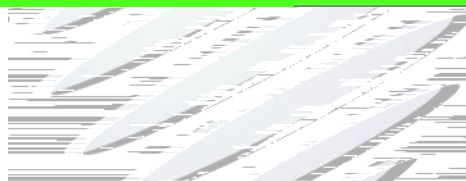
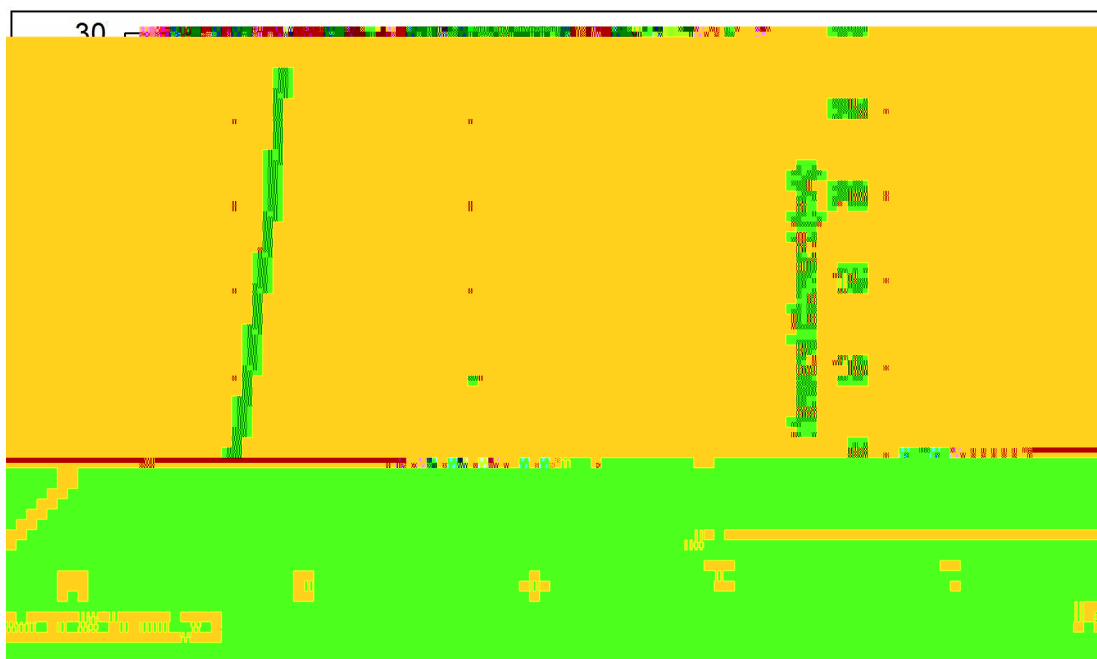

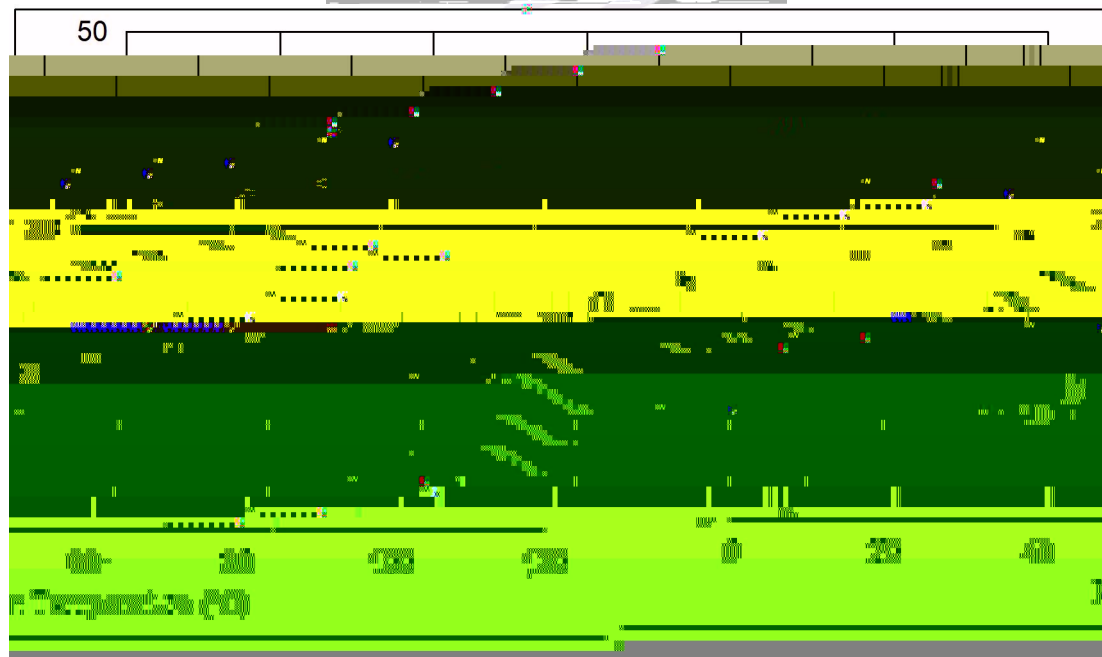
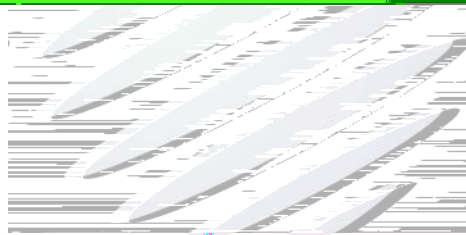
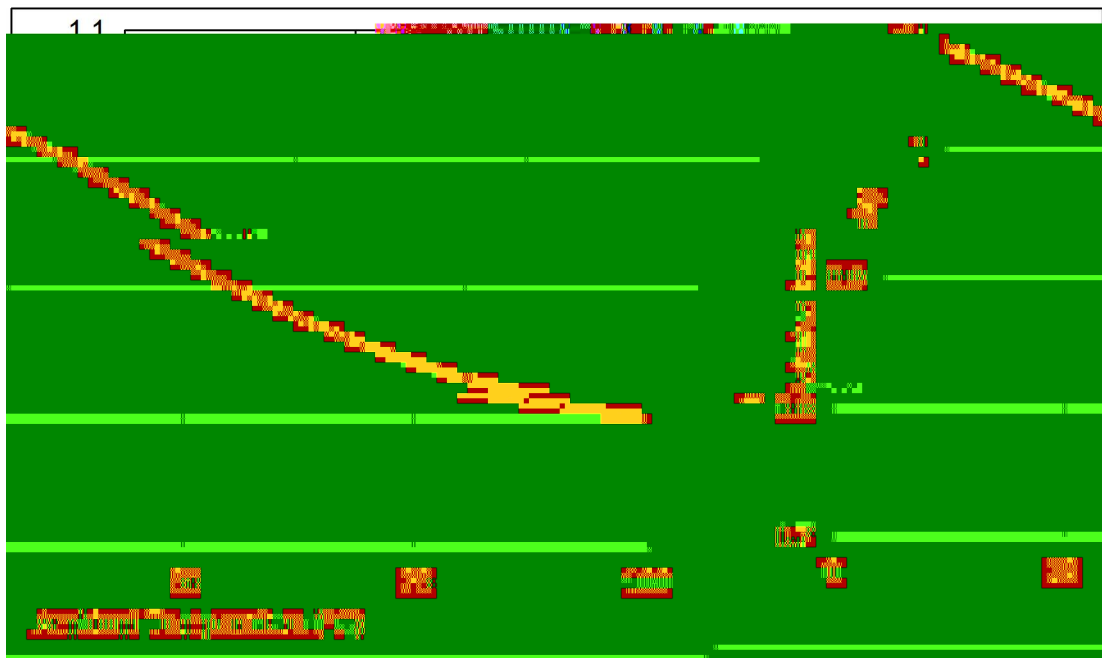

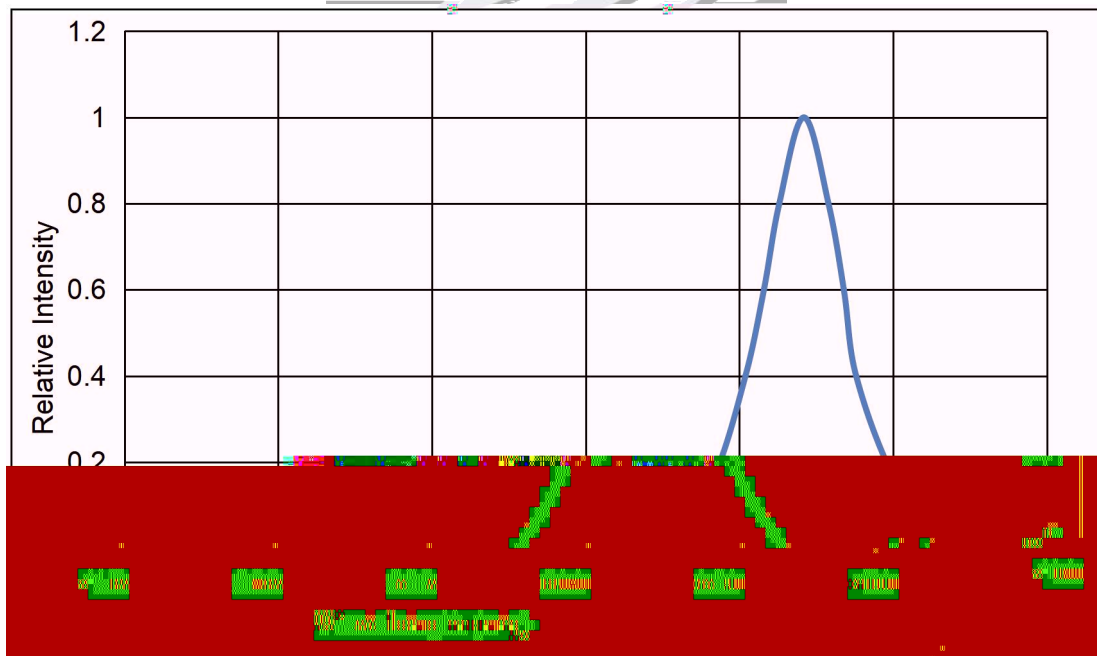
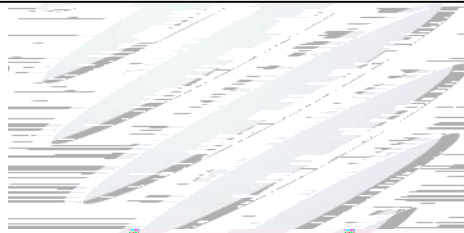
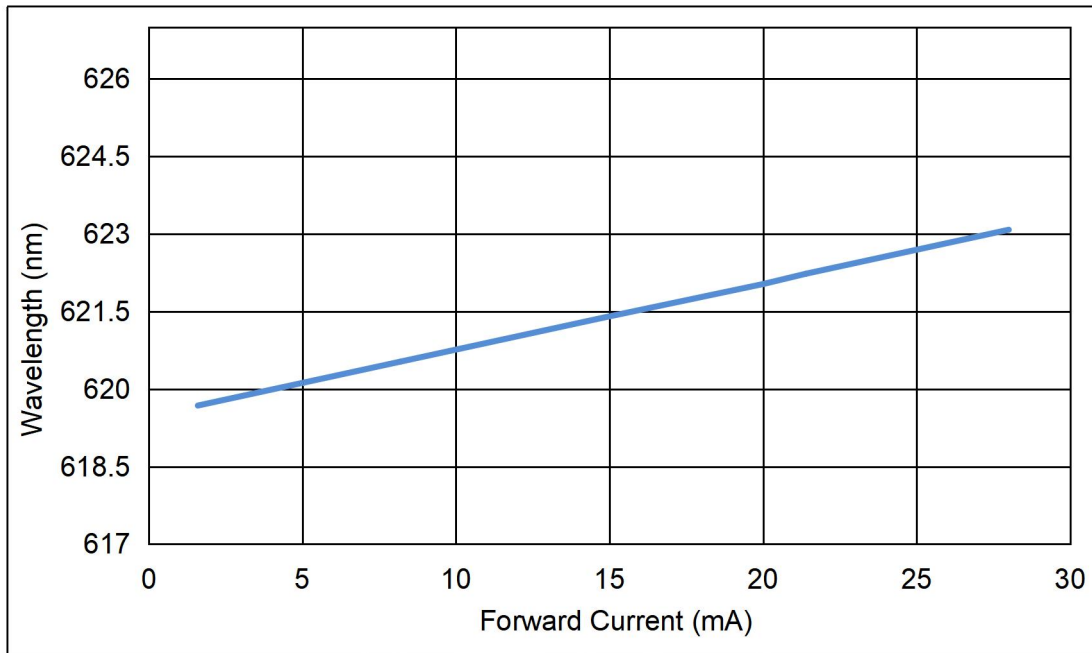

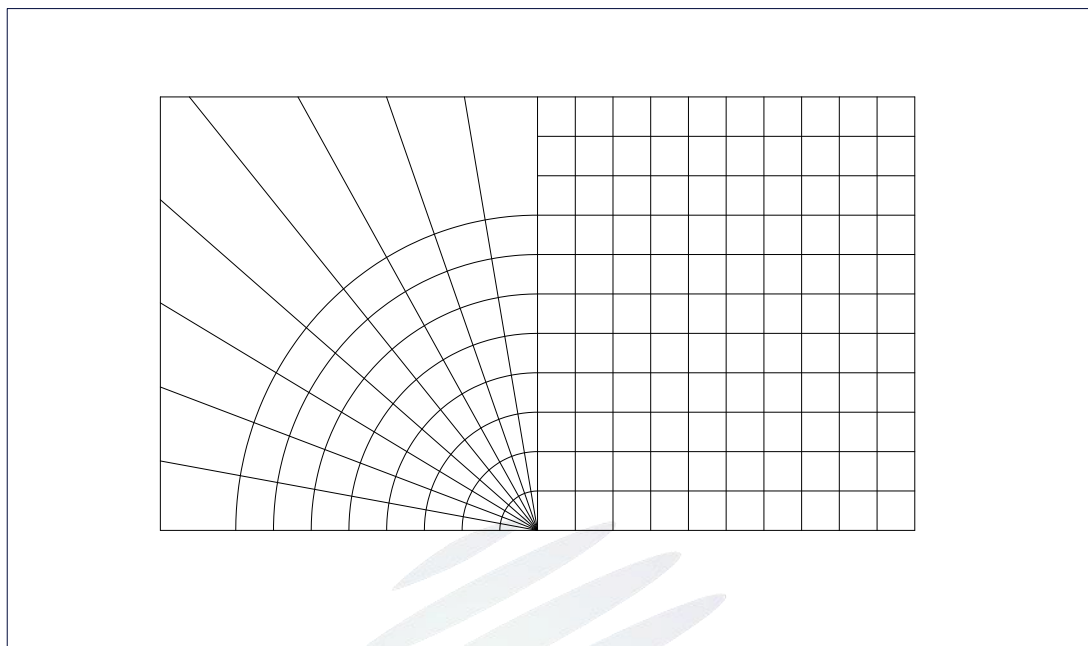

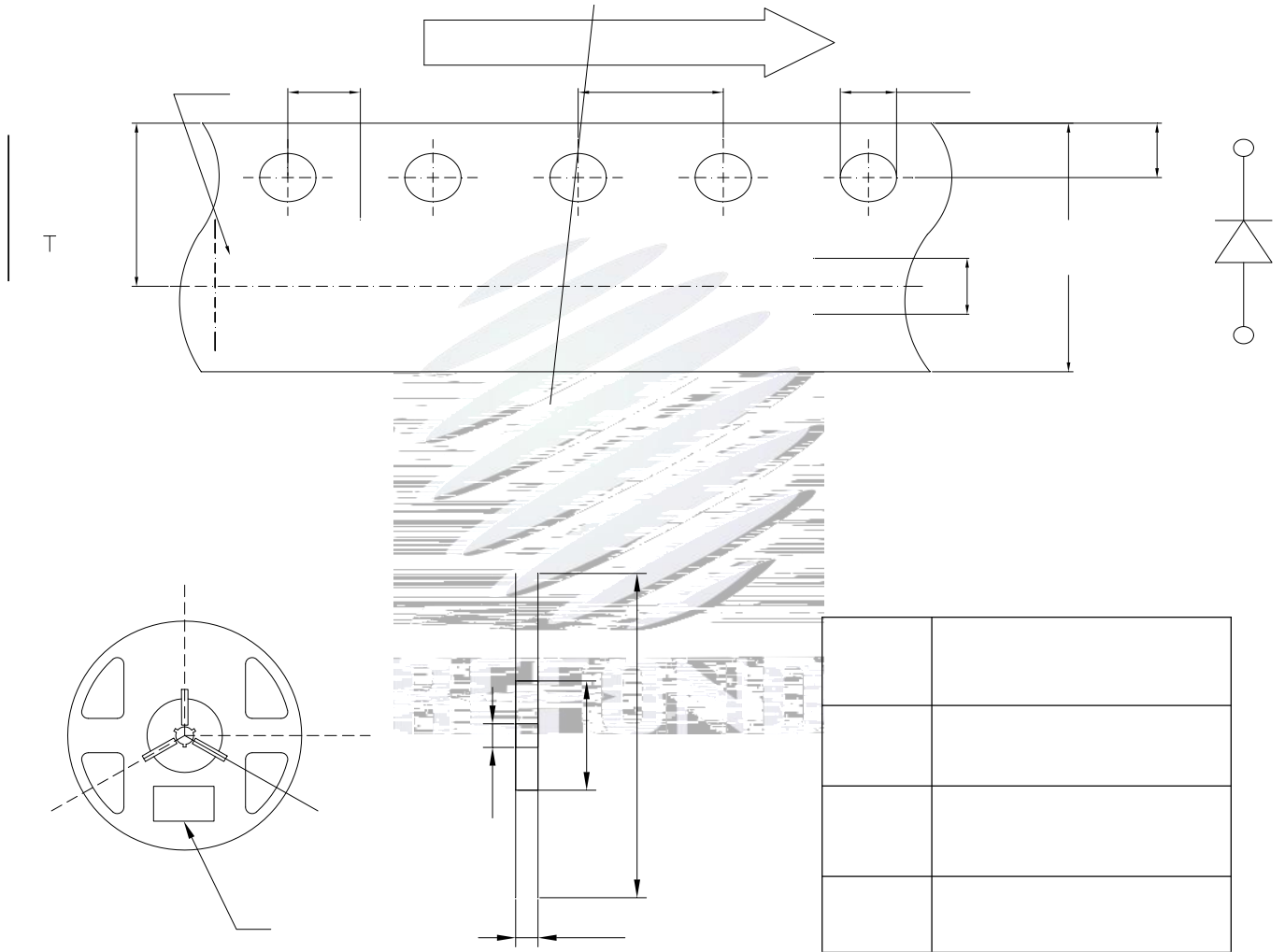



PART NO: SPEC NO: LOT NO	
BIN CODE: Φ: VF:	XY: WLD:
	QTY: DATE:

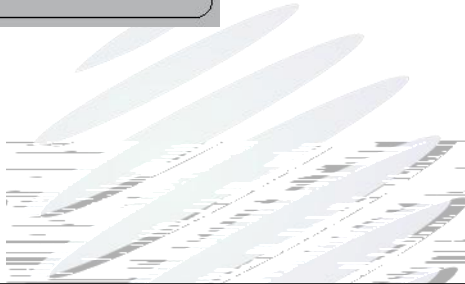

⇒

