

±

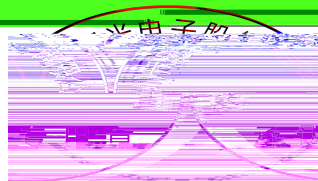

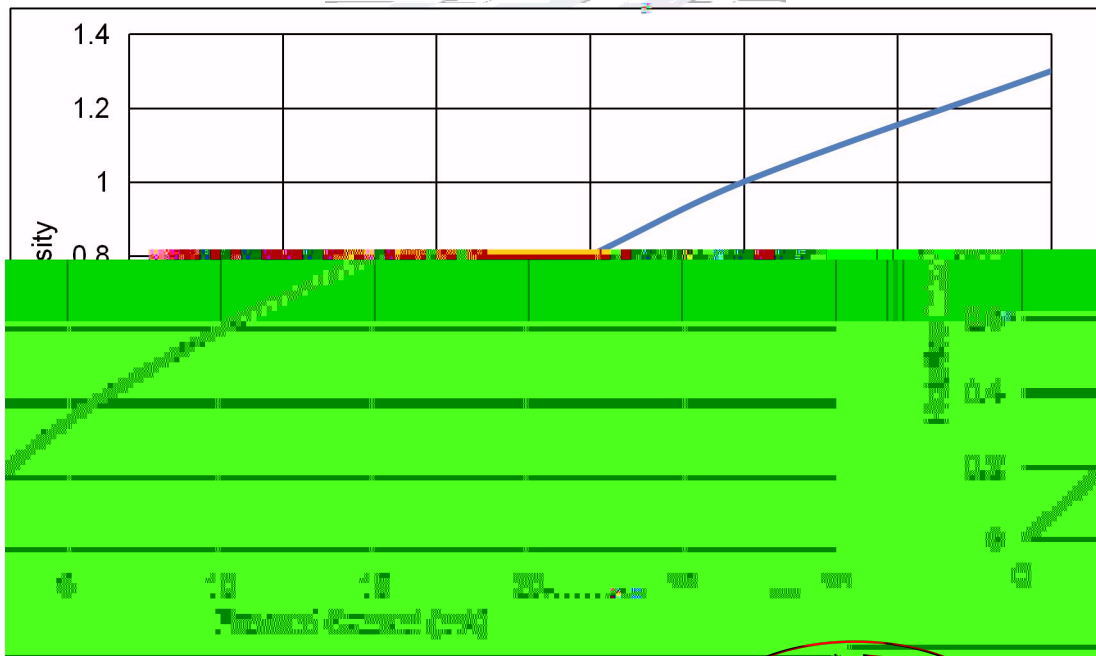

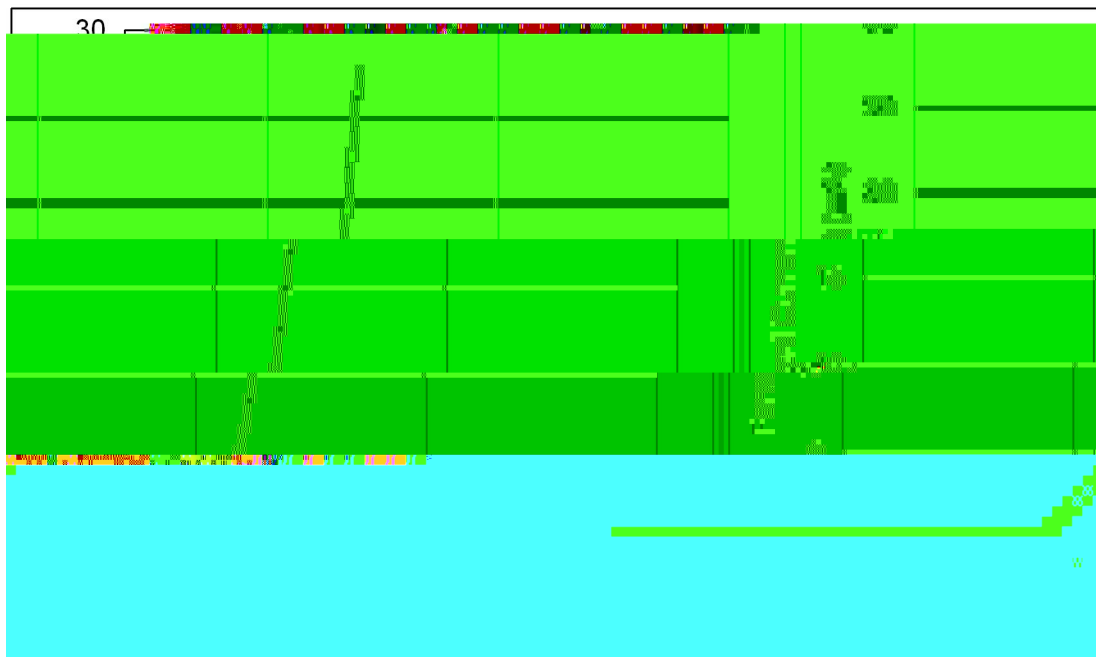

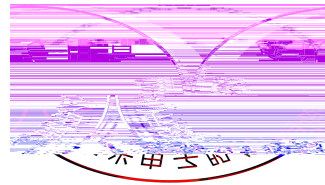

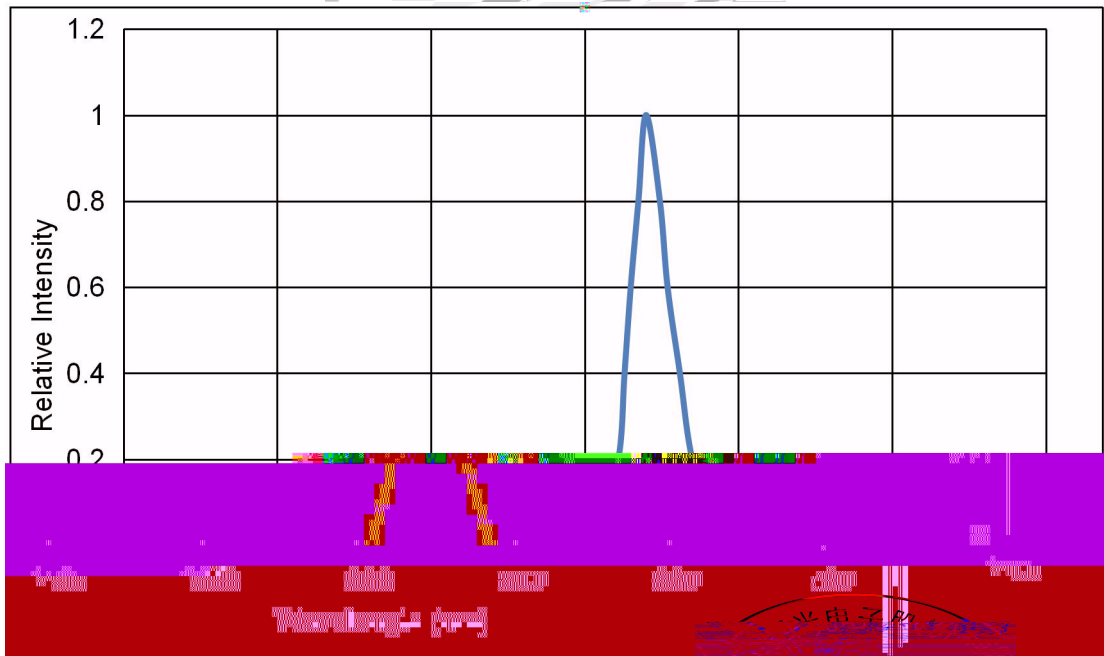
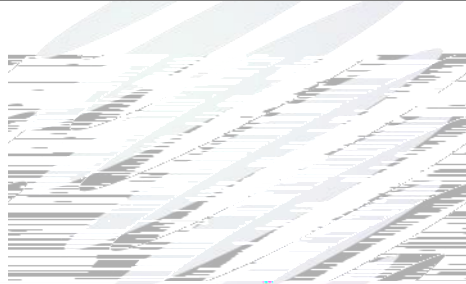
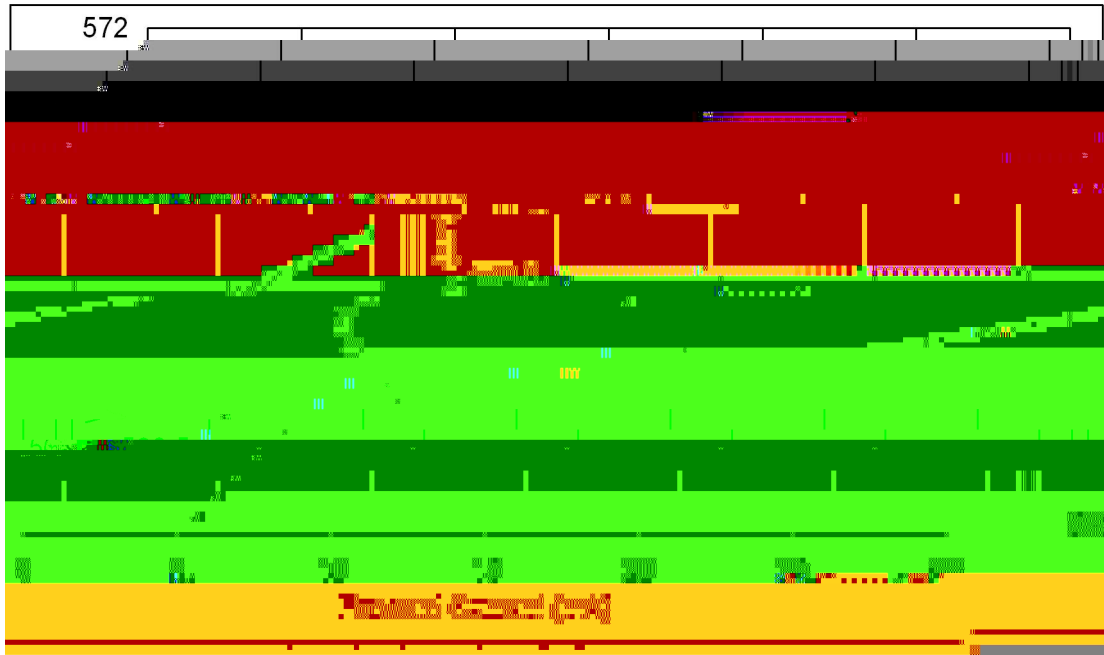

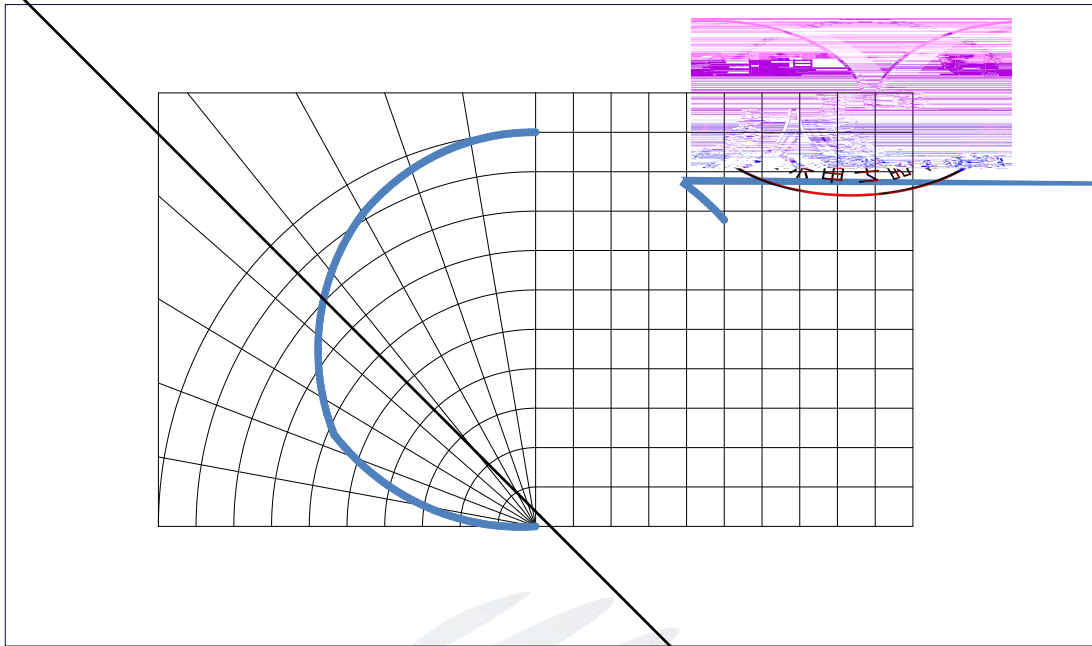

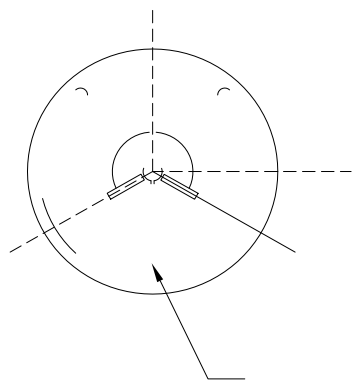





PART NO: .		
SPEC NO:		
LUMINO		
BIN CODE:		
Φ:	XY:	
VF:	WLD:	
	QTY:	
	DATE:	



