

REFOND P/N  
RF-AUB190TS-CA

Mass Product

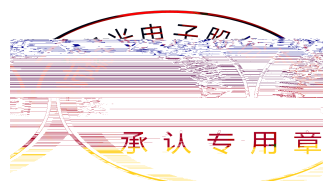

# Contents

- 1. Description
  - 1.1 General Description
  - 1.2 Features
  - 1.3 Application
  - 1.4 Package Dimension
  - 1.5 Product Parameters
  - 1.6 Typical Optical Characteristics Curves
- 2. Packaging
  - 2.1 Packaging Specification
    - 2.1.1 Carrier Tape Dimension
    - 2.1.2 Reel Dimension
    - 2.1.3 Label Form Specification
  - 2.2 Moisture Resistant Packing
  - 2.3 Cardboard Box
  - 2.4 Reliability Test Items And Conditions
  - 2.5 Criteria For Judging Damage
- 3. SMT Reflow Soldering Instructions SMT
  - 3.1 SMT Reflow Soldering Instructions SMT
- 4. Handling Precautions
  - 4.1 Handling Precautions

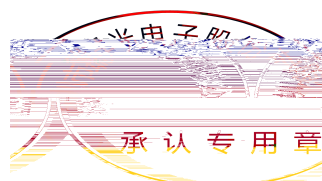
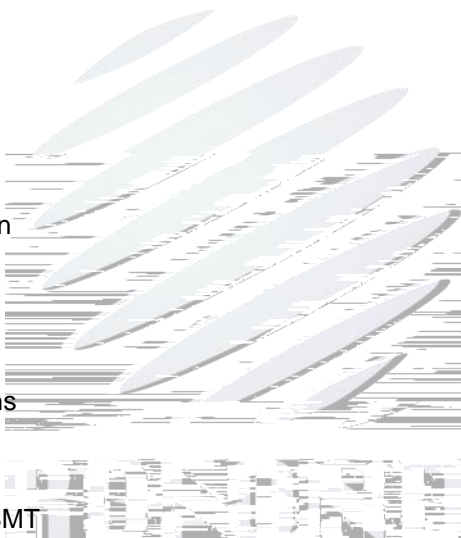

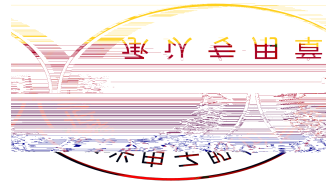

The Colour LED which was fabricated using a amber chip Package Dimension :  
1.6mmX0.8mmX0.7mm.

LED

1.6mmX0.8mmX0.7mm

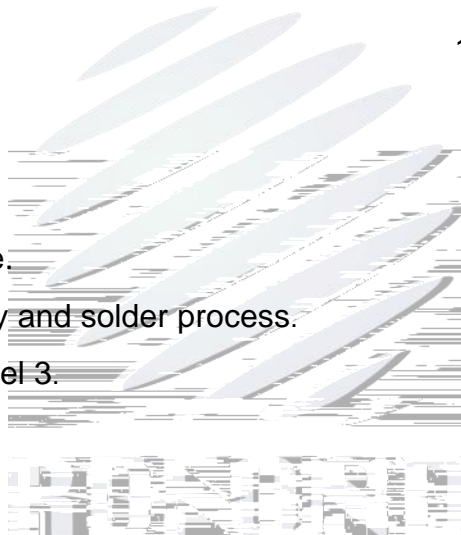

Extremely wide viewing angle.

Suitable for all SMT assembly and solder process.

Moisture sensitivity level: Level 3.

RoHS compliant.

Optical indicator.

Switch and symbol, display.

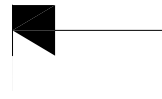
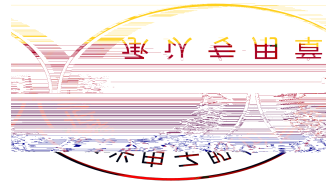
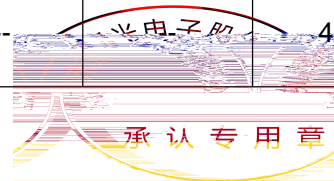

Table 1-1 Electrical / Optical Characteristics at Ts=25°C

Item	Test Condition	Symbol	Value			Unit	
			Min. ( )	Typ.	Max.		
Spectral Half Bandwidth	I <sub>F</sub> =20mA		--	15	--	nm	
Forward Voltage	I <sub>F</sub> =20mA	V <sub>F</sub>	B1	1.8	--	1.9	V
			B2	1.9	--	2.0	V
			C1	2.0	--	2.1	V
			C2	2.1	--	2.2	V
			D1	2.2	--	2.3	V
			D2	2.3	--	2.4	V
Dominant Wavelength	I <sub>F</sub> =20mA	λ <sub>D</sub>	A10	600.0	--	602.5	nm
			A20	602.5	--	605.0	nm
			B10	605.0	--	607.5	nm
			B20	607.5	--	610.0	nm
Luminous Intensity	I <sub>F</sub> =20mA	I <sub>v</sub>	1DW	70	--	90	mcd
			1AP	90	--	120	mcd
			G20	120	--	150	mcd
			1AW	150	--	200	mcd
			1AT	200	--	260	mcd
Viewing Angle	I <sub>F</sub> =20mA	2 1/2	--	140	--	deg	
Reverse Current	V <sub>R</sub> =5V	I <sub>R</sub>	--	--	10	μA	
Thermal Resistance.	I <sub>F</sub> =20mA	R <sub>THJ-S</sub>	--		450	/W	



Notes : V<sub>R</sub>=5V For test conditions. V<sub>R</sub>=5V

Table 1-2 Absolute Maximum Ratings at Ts=25°C

Parameter	Symbol	Rating	Units
Power Dissipation	$P_d$	72	mW
Forward Current	$I_F$	30	mA
Peak Forward Current Of Pulse	$I_{FP}$	60	mA
Reverse Voltage	$V_r$	5	V
Electrostatic Discharge (HBM)	$E_{SD}$	2000	V
Operating Temperature	$T_{opr}$	-40 ~ +85	
Storage Temperature	$T_{stg}$	-40 ~ +85	
Junction Temperature	$T_j$	95	

Notes

1. 1/10 Duty cycle, 0.1ms pulse width.
2. The above forward voltage measurement allowance tolerance is  $\pm 0.1V$ .
3. The above dominant wavelength measurement allowance tolerance is  $\pm 2nm$ .
4. The above luminous intensity measurement allowance tolerance  $\pm 10\%$ .
5. Care is to be taken that power dissipation does not exceed the absolute maximum rating of the product.
6. All measurements were made under the standardized environment of Refond.
7. When the LEDs are in operation the maximum current should be decided after measuring the package temperature, junction temperature should not exceed the maximum rate

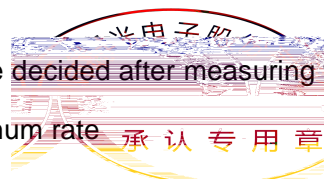

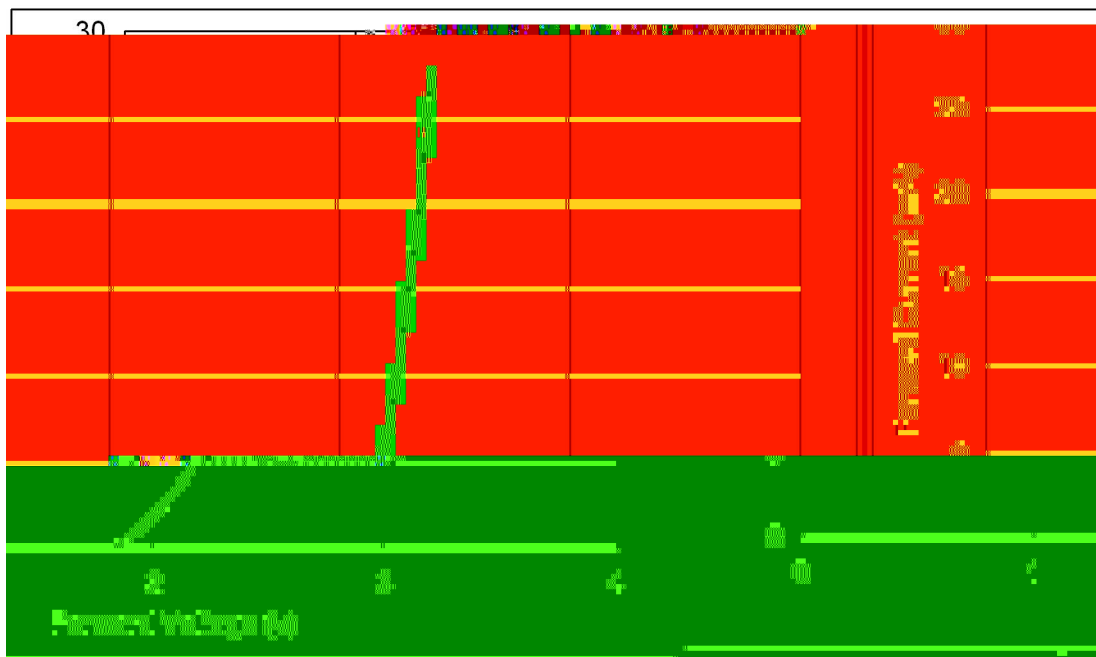

Fig 1-6 Forward Voltage Vs Forward Current

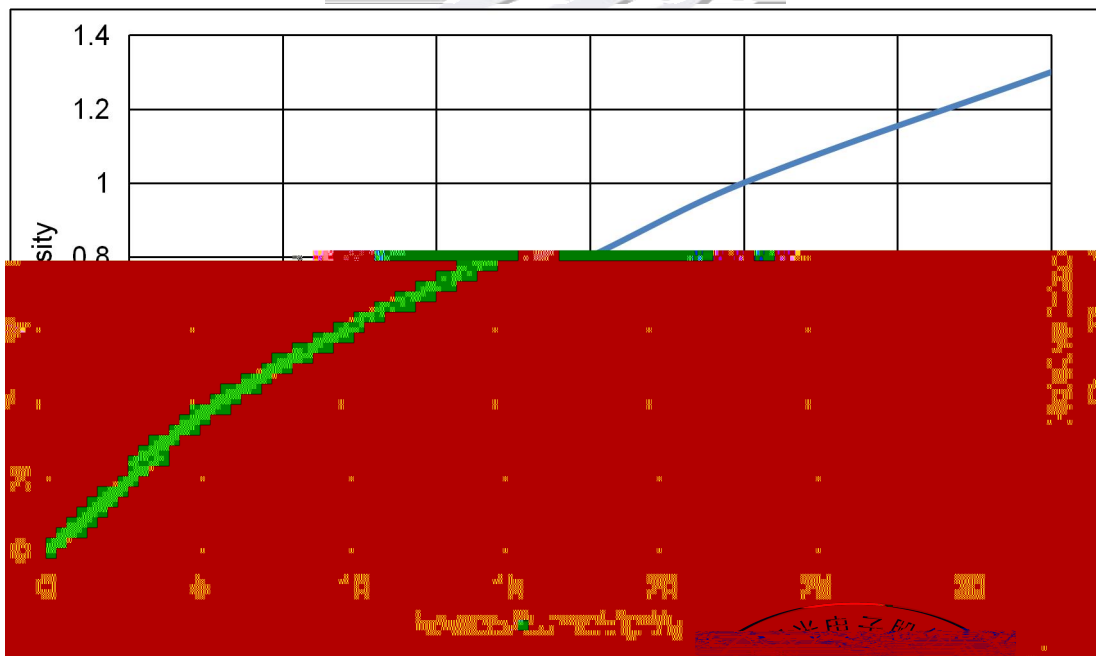
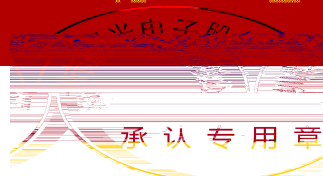

Fig 1-7 Forward Current Vs Relative Intensity



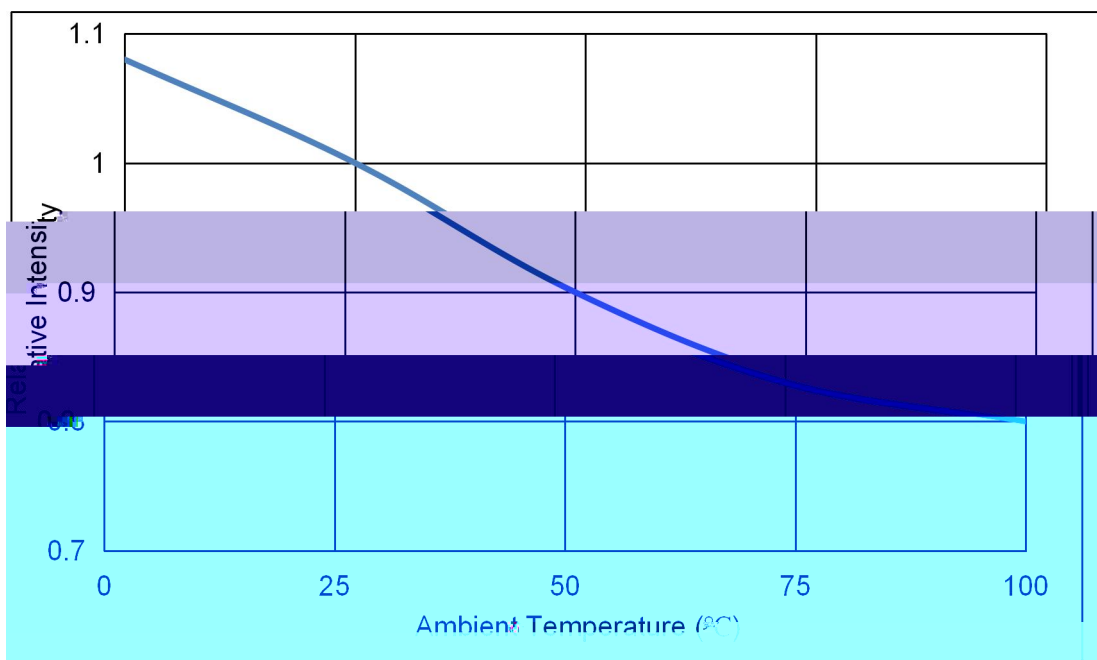

Fig 1-8 Pin Temperature Vs Relative Intensity

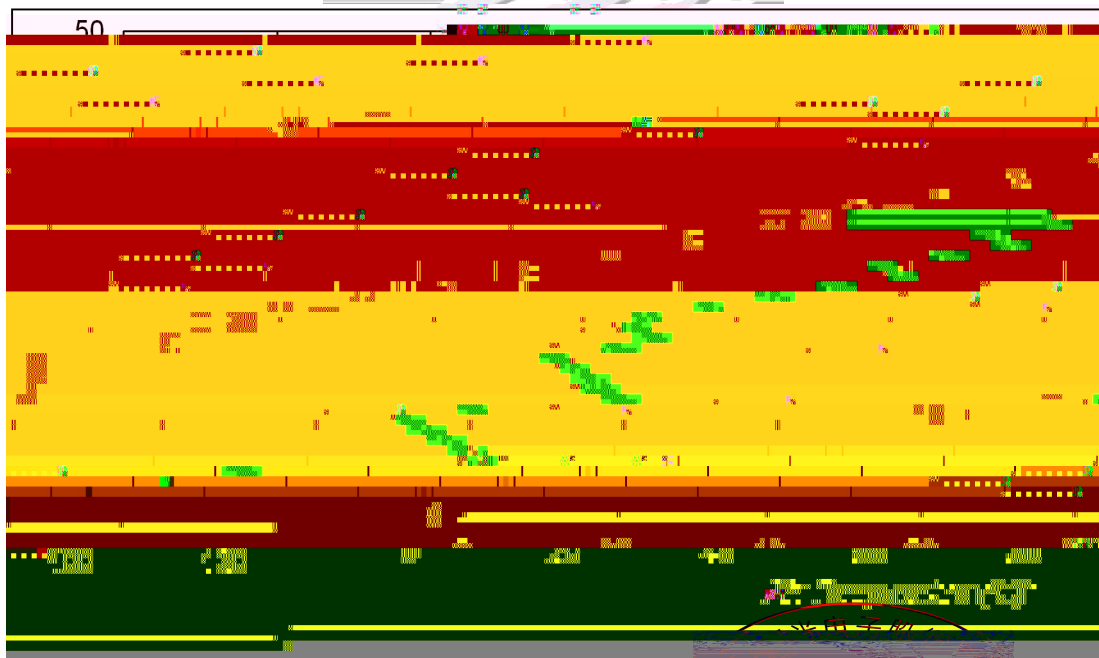

Fig 1-9 Pin Temperature Vs Forward Current





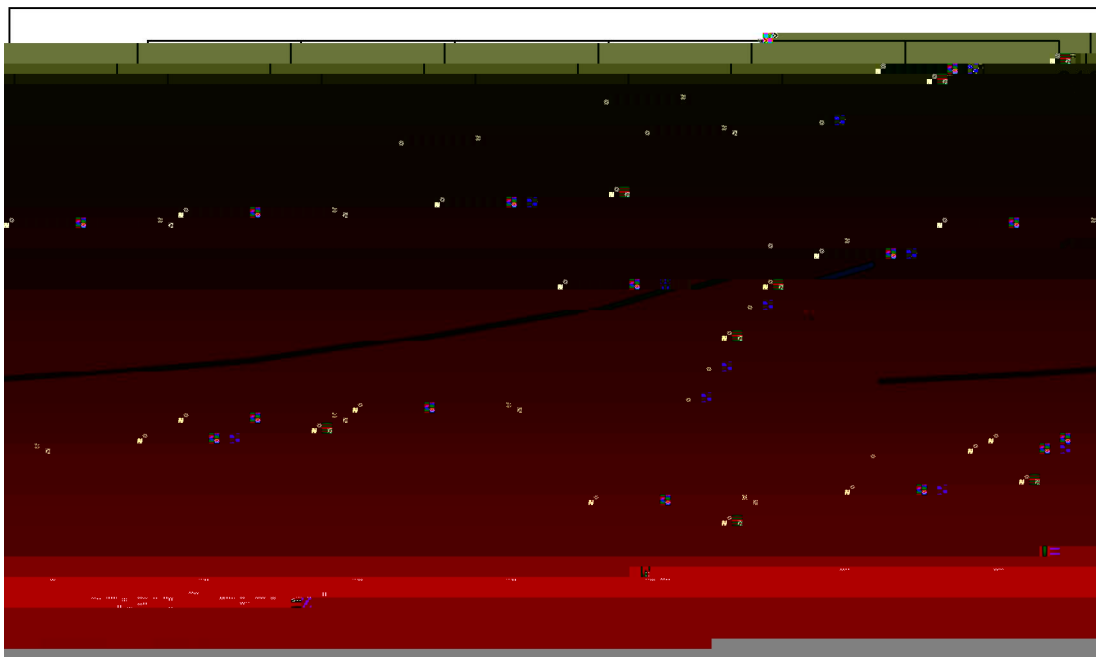

Fig 1-10 Forward Current Vs Dominate Wavelength (Ta=25 )

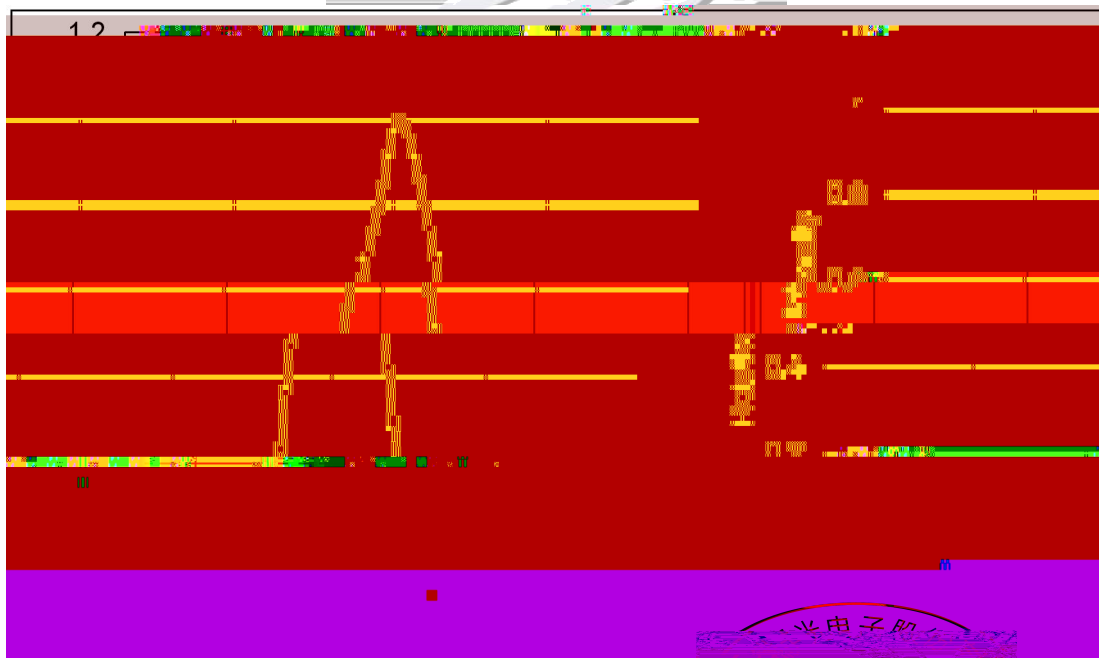
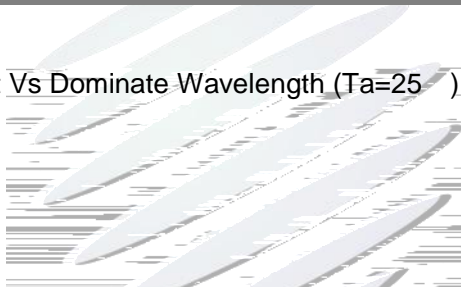
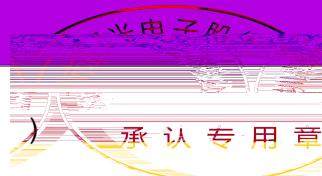

Fig 1-11 Relative Intensity Vs Wavelength (Ta=25 )



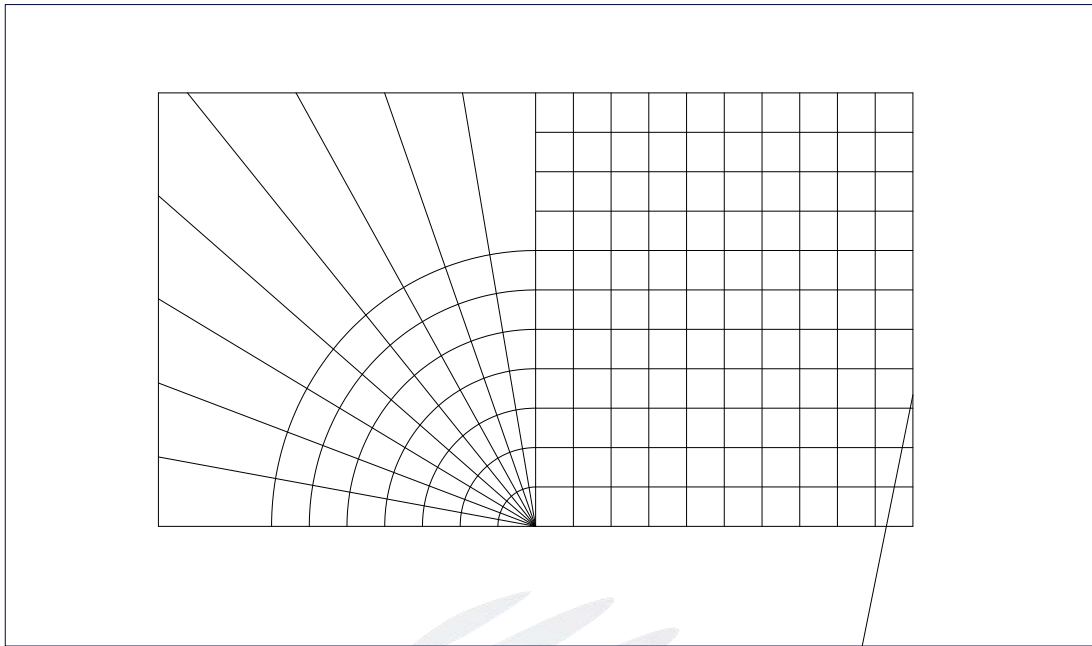

Fig 1-12 Diagram characteristics of radiation



Package:4000pcs/reel.

4000pcs

### 2.1.1 Carrier Tape Dimension

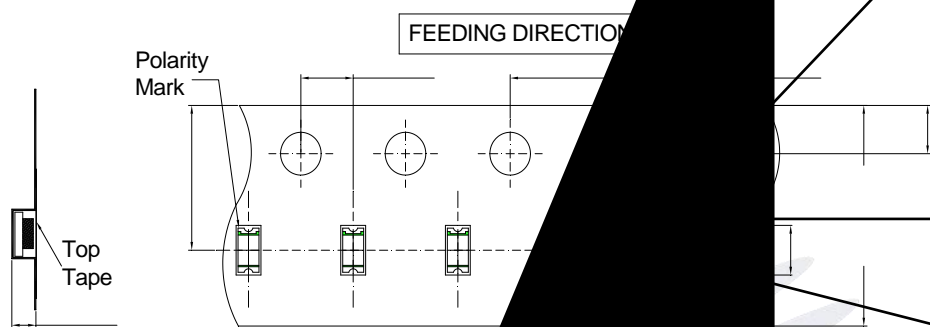

Fig. 1 Carrier Tape Dimension

### 2.1.2 Reel Dimension

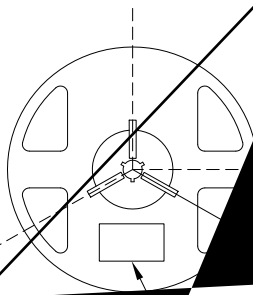

Fig.2

Table 2-1 Dimension

	8.0	0.1mm
	178	1mm

#### Notes

The tolerance is defined  $\pm 0.1\text{mm}$ . Unit : mm

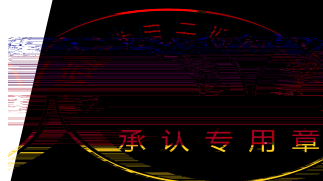

### 2.1.3 Label Form Specification



Fig. 2-3 Label Form Specification



Fig.2-

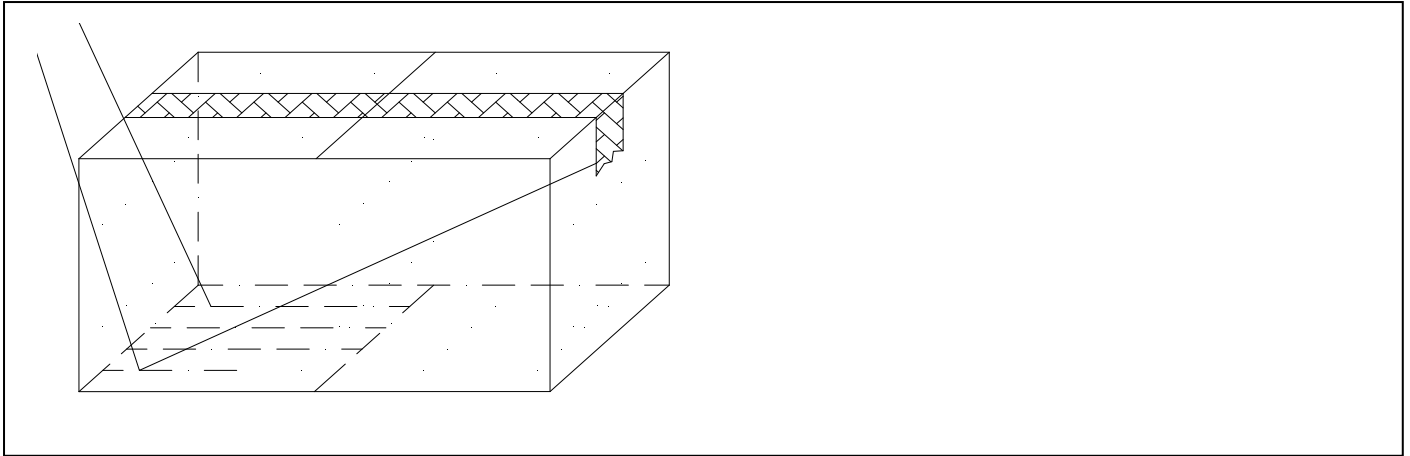

Fig.2-5 Cardboard Box

Table 2-3 Reliability Test Items And Conditions

Test Items	Ref.Standard	Test Condition	Time	Quantity	Ac/Re /
Reflow	JESD22-B106	$T_{emp}: 260 \text{ max}$ $T=10 \text{ sec}$	2 times	22Pcs.	0/1
Temperature Cycle	JESD22-A104	100 30 min 5 min -40 30 min	100 cycles	22Pcs.	0/1
Thermal Shock	JESD22-A106	-40 15min 100 15min	300 cycles	22Pcs.	0/1
High Temperature Storage	JESD22-A103	$T_{emp}: 100$	1000 hrs.	22Pcs.	0/1
Low Temperature Storage	JESD22-A119	$T_{emp}: -40$	1000 hrs.	22Pcs.	0/1
Life Test	JESD22-A108	$T_a=25$ $I_f=20\text{mA}$	1000 hrs.	22Pcs.	0/1

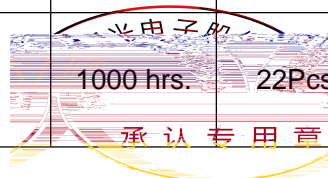

Table 2-4 Criteria For Judging Damage

Test Items	Symbol	Test Condition	Criteria For Judgement	
			Min.	Max.
Forward Voltage	$V_F$	$I_F=20\text{mA}$	-	U.S.L*)x1.1
Reverse Current	$I_R$	$V_R= 5\text{V}$	-	U.S.L*)x2.0
Luminous Flux		$I_F=20\text{mA}$	L.S.L*)x0.7	-

Notes

1.U.S.L: Upper standard level

L.S.L: Lower standard level

2.The above reliability tests is based on the verification of a single/strip LED of Refond's existing experimental platform,the reliability experiment was taken under good heat dissipation conditions. When customers applies the LED to the series and parallel circuit,should take consideration of all the factors such as the current, voltage distribution, heat dissipation and others.

3.The technical information shown in the data sheets is limited to the typical characteristics and circuit examples of the referenced products. It does not constitute the warranting of industrial property nor the granting of any license.

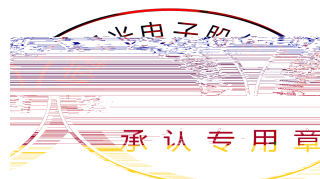

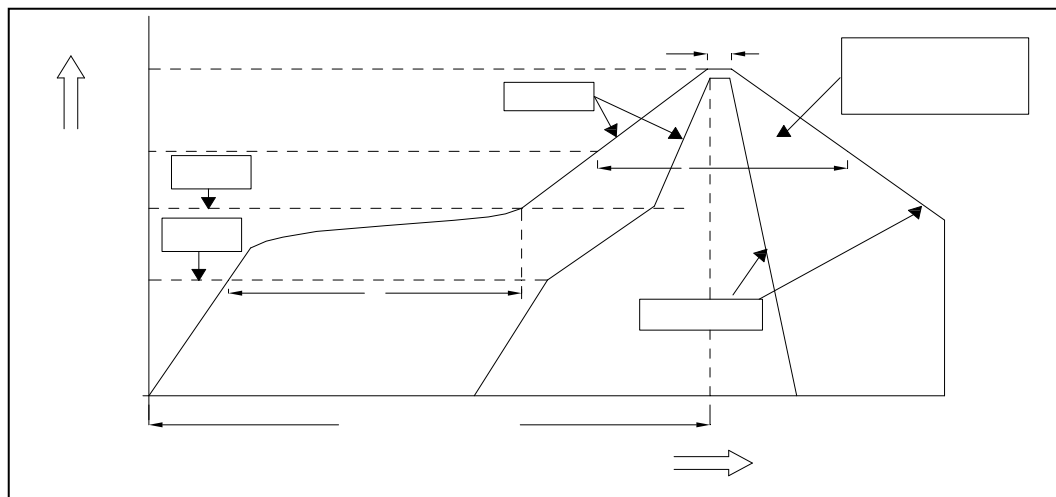
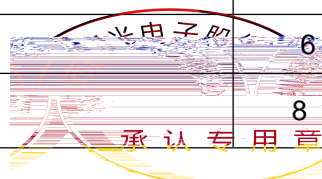

Fig.3-1 SMT Reflow Soldering Instructions SMT

Table 3-1 Parameter

Average temperature rise speed	$T_{smax} - T_P$	3 °C/ s	Max 3 °C/ s
Preheating: minimum temperature	( $T_{smin}$ )	150 °C	
Preheating: Max temperature	( $T_{smax}$ )	200 °C	
Preheating: Time	$T_{smin} - T_{smax}$	60 - 120	60s-120s
Time limited to maintain high temperature: the temperature	( $T_L$ )	217 °C	
Time limited to maintain high temperature: The Time	( $t_L$ )	60	Max 60s
Peak /Classification of temperature:	( $T_P$ )	260 °C	
Time limit classification of peak temperature time	$t_p$	10	Max 10s
Hold time within 5 °C with the actual peak temperature (TP)	( $T_P$ )	30	Max 30s
Cooling speed		6 °C/ s	Max 6 °C/ s
Needed time from 25 °C to $T_P$	25 °C	8	Max 8 minutes



Notes

(1)Reflow soldering should not be done more than twice. If more than 24 hours between the two solderings , LED will be damaged.

(2)When soldering , do not put stress on the LEDs during heating.

3.1.1 Soldering Iron

(1) When do soldering by hand, keep the temperature of iron below less 300 less than 3 seconds

(2) Soldering by hand should be done only one time.

3.1.2 Repairing

Repairing should not be done after the LEDs have been soldered. When repairing is unavoidable,a double-head soldering iron should be used (as below figure). It should be confirmed in advance whether the characteristics of LEDs will or not be damaged by repairing.

LED

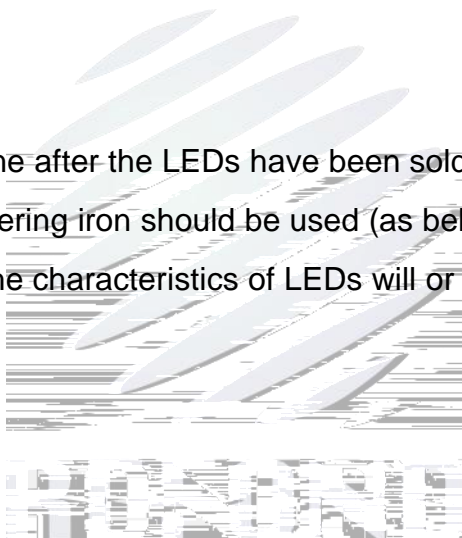

3.1.3 Cautions

(1) Components should not be mounted on warped (non coplanar) portion of PCB. After soldering, do not warp the circuit board.LED

(2) Do not apply mechanical force or excess vibration during the cooling process to normal temperature after soldering. Do not rapidly cool device after soldering.

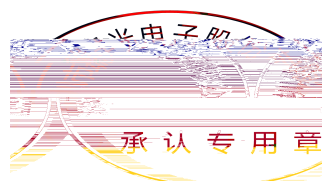



(1) LED operating environment and sulfur element composition cannot be over 100PPM in the LED mating usage material. This is provided for informational purposes only and is not a warranty or endorsement. LED

(2) In order to prevent external material from getting into the inside of LED, which may cause the malfunction of LED, the single content of Bromine element is required to be less than 900PPM, the single content of Chlorine element is required to be less than 900PPM, the total content of Bromine element and Chlorine element in the external materials of the application products is required to be less than 1500PPM. This is provided for informational purposes only and is not a warranty or endorsement.

(3) VOCs (Volatile organic compounds) emitted from materials used in the construction of fixtures can penetrate silicone encapsulants of LEDs and discolor when exposed to heat and photonic energy. The result can be a significant loss of light output from the fixture. Knowledge of the properties of the materials selected to be used in the construction of fixtures can help prevent these issues. Refond advises against the use of any chemicals or materials that have been found or are suspected to have an adverse effect on device performance or reliability. To verify compatibility, Refond recommends that all chemicals and materials be tested in the specific application and environment for which they are intended to be used. Attaching LEDs, do not use adhesives that outgas organic vapor.

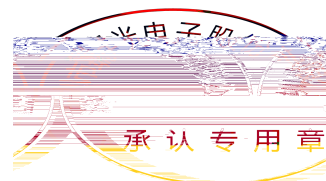

(4) In designing a circuit, the current through each LED can not exceed the absolute maximum rating specified for each LED. In the meanwhile, resistors for protection should be added

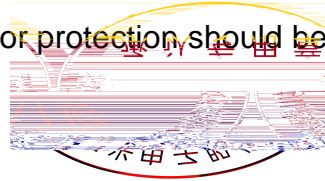

(8) Similar to most Solid state devices; LEDs are sensitive to Electro-Static Discharge (ESD) and Electrical Over Stress (EOS).

(9) Other points for attention, please refer to our relevant information.

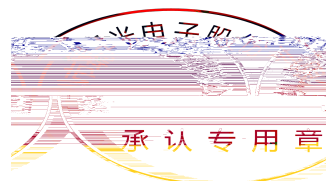



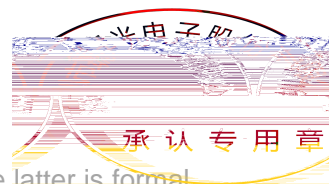

Declare

This specification is written both in English and in Chinese and the latter is formal.