

Contents

- 1. Description
 - 1.1 General Description
 - 1.2 Features
 - 1.3 Application
 - 1.4 Package Dimension
 - 1.5 Product Parameters
 - 1.6 Typical optical characteristics curves
- 2. Packaging
 - 2.1 Packaging Specification
 - 2.1.1 Carrier Tape Dimension
 - 2.1.2 Reel Dimension
 - 2.1.3 Label Form Specification
 - 2.2 Moisture Resistant Packing
 - 2.3 Cardboard Box
 - 2.4 Reliability Test Items And Conditions
 - 2.5 Criteria For Judging Damage
- 3. SMT Reflow Soldering Instructions SMT
 - 3.1 SMT Reflow Soldering Instructions SMT
- 4. Handling Precautions
 - 4.1 Handling Precautions

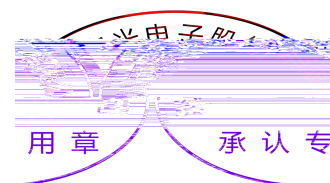
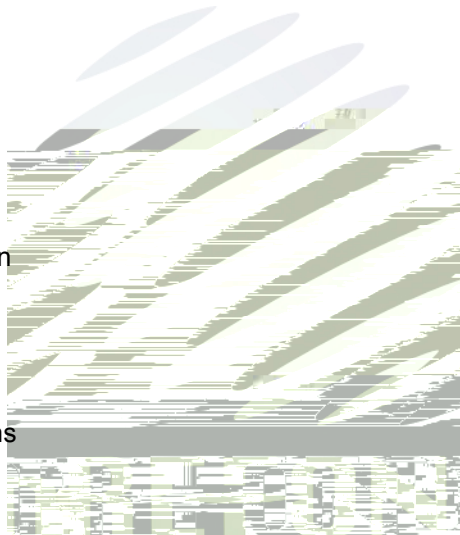

The Colour LED which was fabricated using a yellow chip Package Dimension :
3.2mmX1.6mmX1.88mm.

3.2mmX1.6mmX1.88mm

- ▶ Narrow viewing angle.
- ▶ Suitable for all SMT assembly and solder process.
- ▶ Moisture sensitivity level: Level 3.
- ▶ RoHS compliant.

SMT

Level 3

RoHS

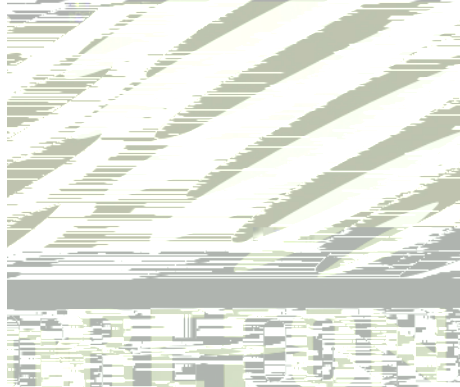

- ▶ Optical indicator.
- ▶ Switch and Symbol, Display.
- ▶ General use.

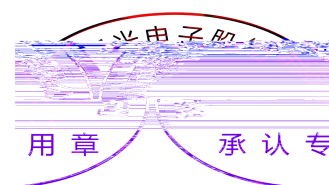

REFOND

REFOND

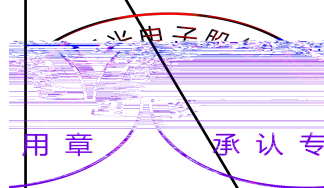
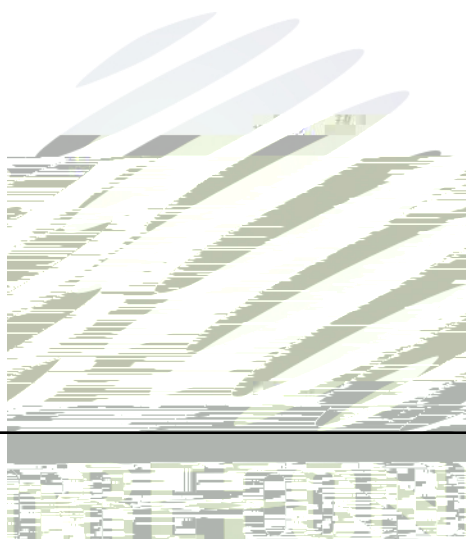

Tel: +86-755-66839118 Fax: +86-755-66839300 E-mail: sales@refond.com Web: www.refond.com

创新科技. 丰富人类生活!
Innovation enrich life

Table 1-1 Electrical / Optical Characteristics at Ts=25°C

Item	Test Condition	Symbol	Value	Unit
		B0	1.8	--
		C0	2.0	--
		D0	2.2	--
		E0	2.4	--
		F0	2.6	--
		G0	2.8	--
		2K	585	--
		2L	590	--
		K00	530	--

Note :V_R=5V For test conditions.V_R=5V

Table 1-2 Absolute Maximum Ratings at Ts=25°C

Parameter	Symbol	Rating	Units
Power Dissipation	P_d	90	mW
Forward Current	I_F	30	mA
Peak Forward Current Of Pulse	I_{FP}	60	mA
Electrostatic Discharge (HBM)	E_{SD}	2000	V
Operating Temperature	T_{opr}	-40 ~ +85	
Storage Temperature	T_{stg}	-40 ~ +85	
Junction Temperature	T_j	95	

Notes

- 1/10 Duty cycle, 0.1ms pulse width.
- The above forward voltage measurement allowance tolerance is $\pm 0.1V$.
- The above dominant wavelength measurement allowance tolerance is 2nm.
- The above luminous intensity measurement allowance tolerance $\pm 10\%$.
- Care is to be taken that power dissipation does not exceed the absolute maximum rating of the product.
- All measurements were made under the standardized environment of Refond.
- When the LEDs are in operation the maximum current should be decided after measuring the package temperature junction temperature should not exceed the maximum rate

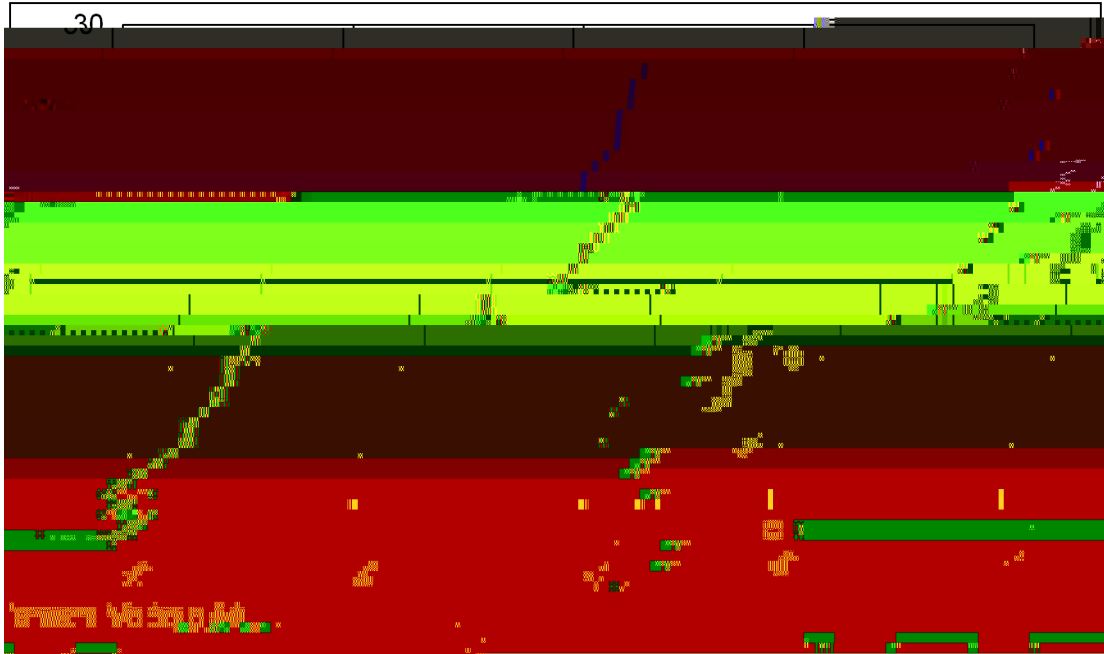

Fig 1-6 Forward Voltage Vs. Forward Current

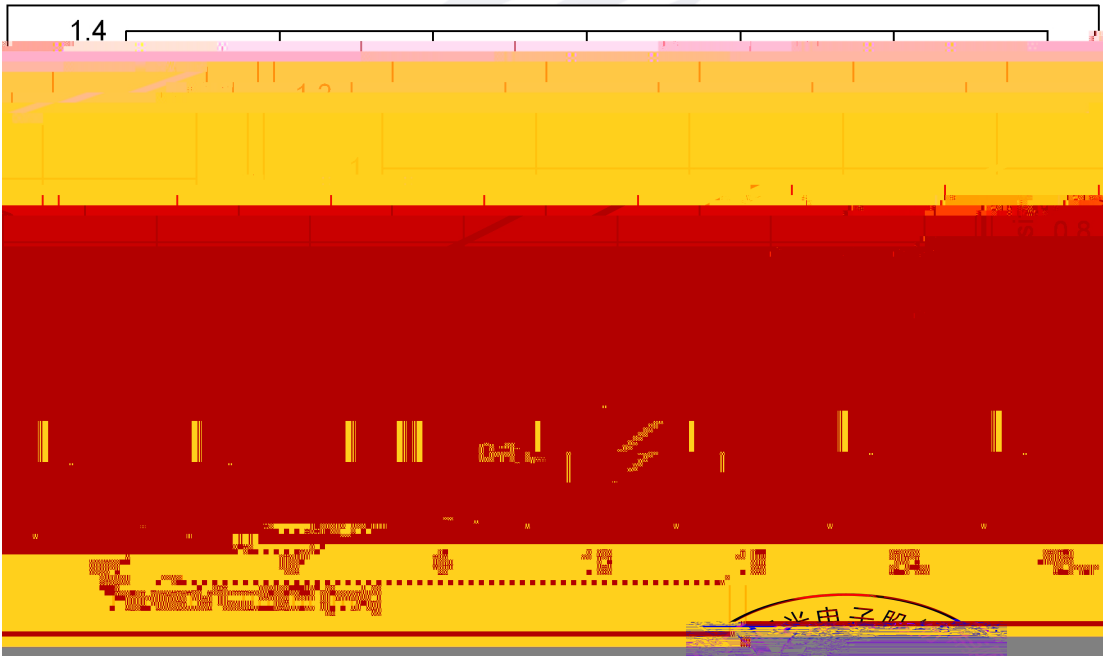

Fig 1-7 Forward Current Vs. Relative Intensity



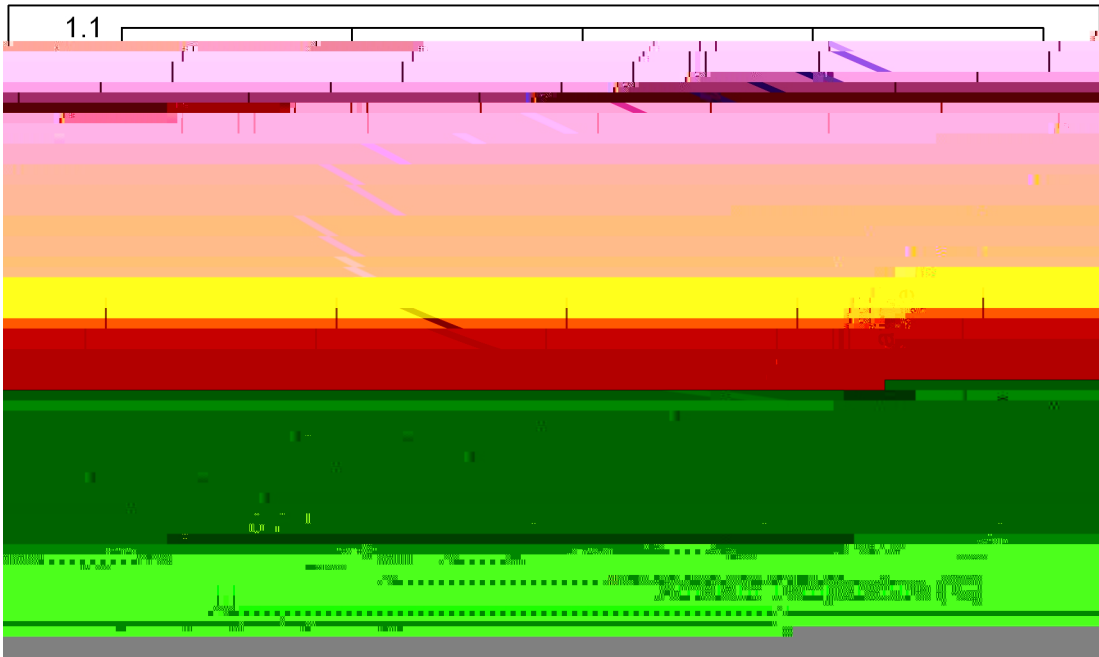

Fig 1-8 Solder Temperature Vs Relative Intensity

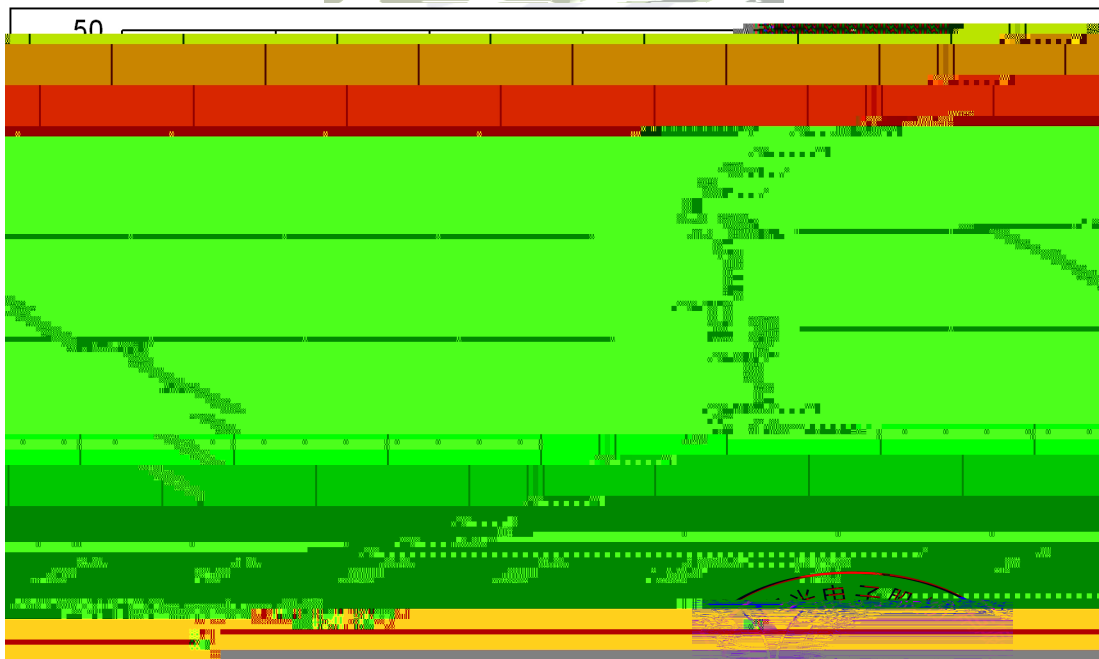
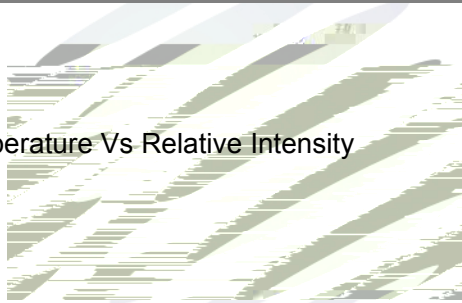

Fig 1-9 Solder Temperature Vs Forward Current

用章 承认专



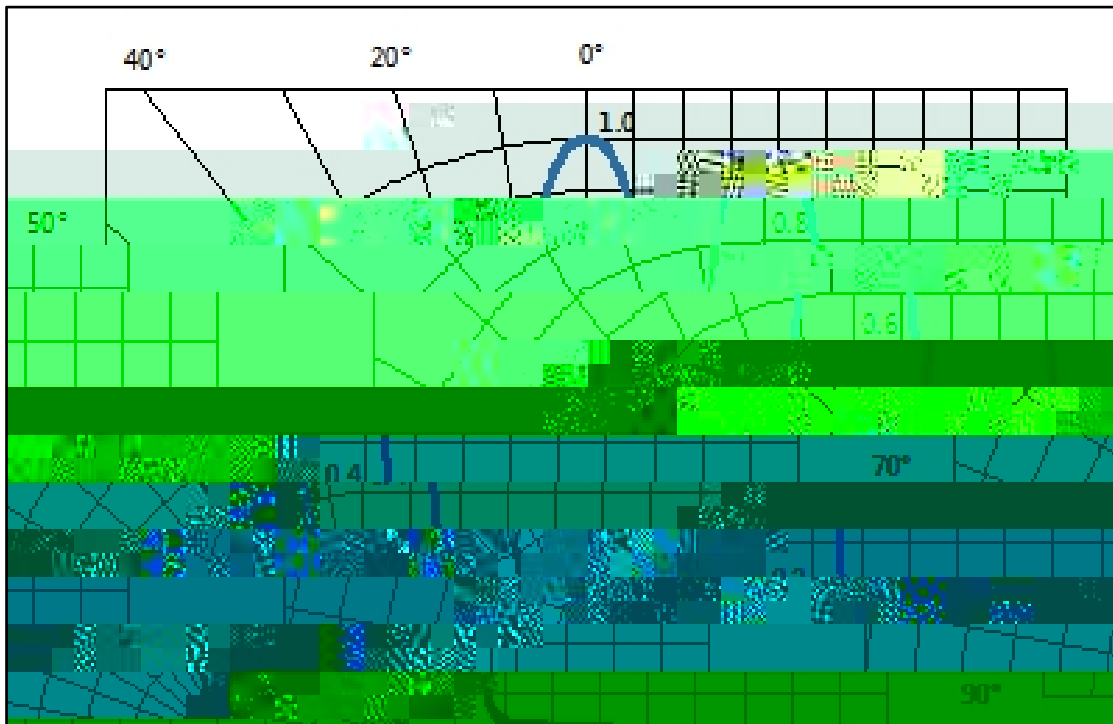
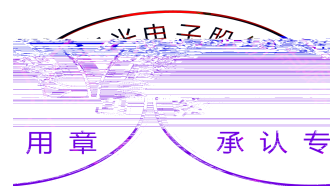
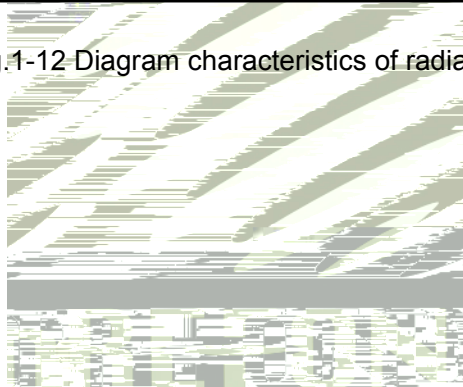

Fig.1-12 Diagram characteristics of radiation



Package:2000pcs/reel. 2000pcs

Carrier Tape Dimension

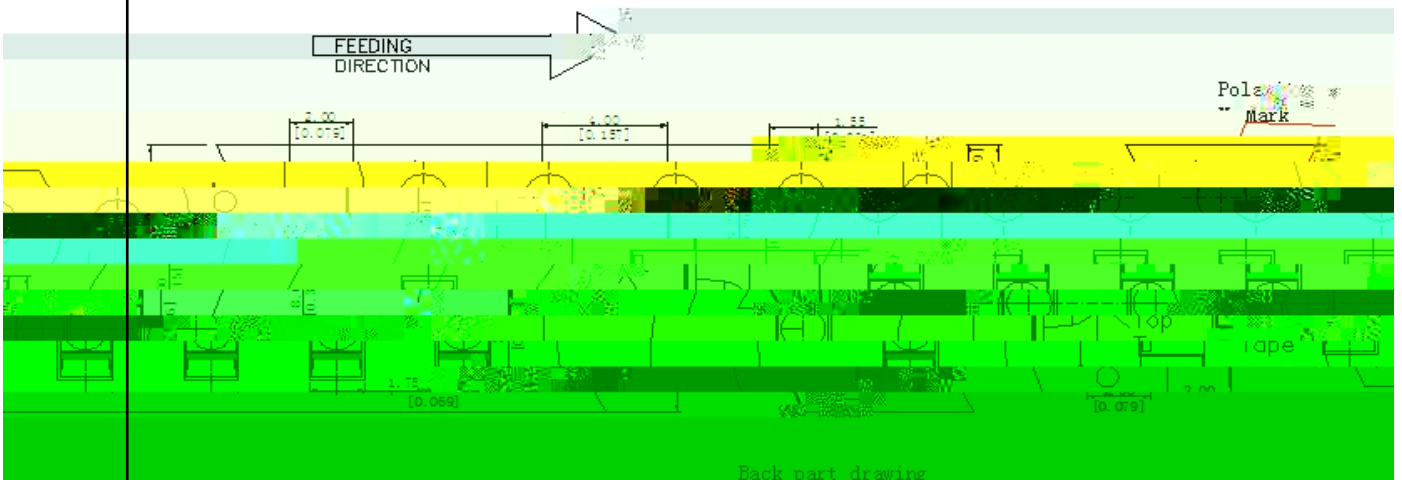
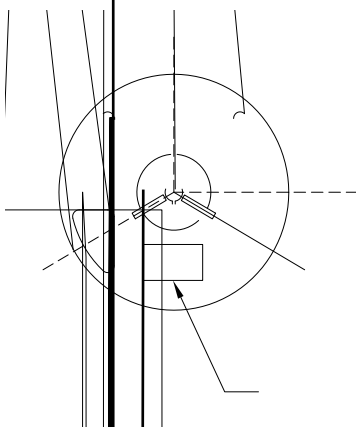

Fig.2-1 Carrier Tape Dimension

2.1.2 Reel Dimension



A	8.0 0.1mm
B	178 1mm
C	60 1mm
D	13.0 0.5mm

Note: The tolerances unless mentioned ± 0.1 mm. Unit : mm

Refond

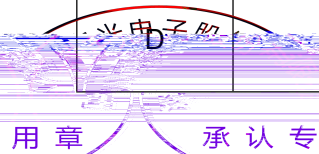

2.1.3 Label Form Specification

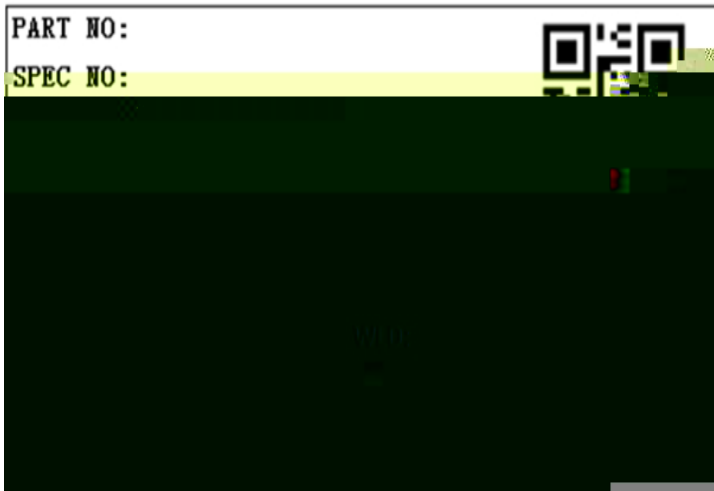

PART NO.	Part Number
SPEC NO.	Spec Number
LOT NO.	Lot Number
BIN CODE	Bin Code
Φ	Luminous flux
XY	Chromaticity Bin
V_F	Forward Voltage
WLD	Wavelength
QTY	Packing Quantity
DATE	Made Date

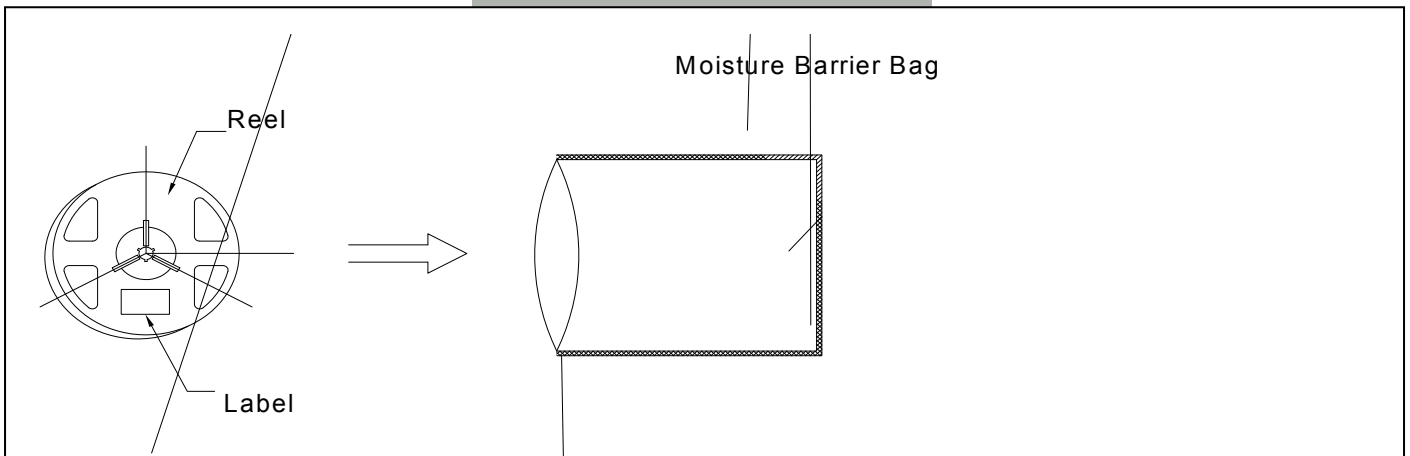

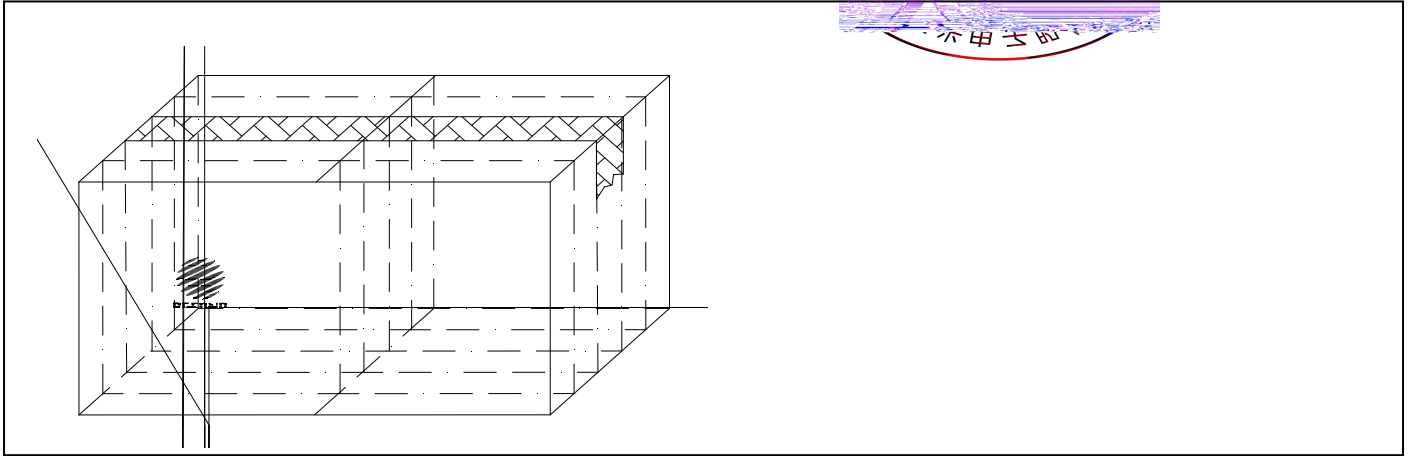
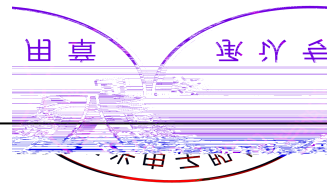

Fig 2-5 Cardboard Box

Table 2-3 Reliability Test Items And Conditions

Test Items	Ref.Standard	Test Condition	Time	Quantity	Ac/Re /
Reflow	JESD22-B106	Temp:260 max T=10 sec	2 times	22Pcs	0/1
Temperature Cycle	JESD22-A104	100 30 min ↑↓5 min -40 30 min	100 cycles	22Pcs	0/1
Thermal Shock	JESD22-A106	-40 15min ↑↓ 100 15min	300 cycles	22Pcs	0/1
High Temperature Storage	JESD22-A103	Temp:100	1000 hrs	22Pcs	0/1
Low Temperature Storage	JESD22-A119	Temp:-40	1000 hrs	22Pcs	0/1
Life Test	JESD22-A108	T _a =25 I _F =20mA	1000 hrs	22Pcs	0/1

Table 2-4 Criteria For Judging Damage

Test Items	Symbol	Test Condition	Criteria For Judgement	
			Min.	Max.
Forward Voltage	V_F	$I_F=20mA$	-	U.S.L*)x1.1
Reverse Current	I_R	$V_R= 5V$	-	U.S.L*)x2.0
Luminous Flux	Φ	$I_F=20mA$	L.S.L*)x0.7	-

Notes

1.U.S.L: Upper standard level

L.S.L: Lower standard level

2.The above reliability tests is based on the verification of a single/strip LED of Refond's existing experimental platform,the reliability experiment was taken under good heat dissipation conditions. When customers applies the LED to the series and parallel circuit,should take consideration of all the factors such as the current, voltage distribution, heat dissipation and others.

3.The technical information shown in the data sheets is limited to the typical characteristics and circuit examples of the referenced products. It does not constitute the warranting of industrial property nor the granting of any license.

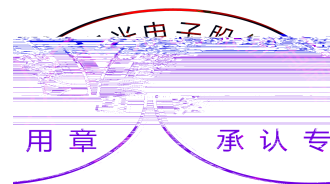

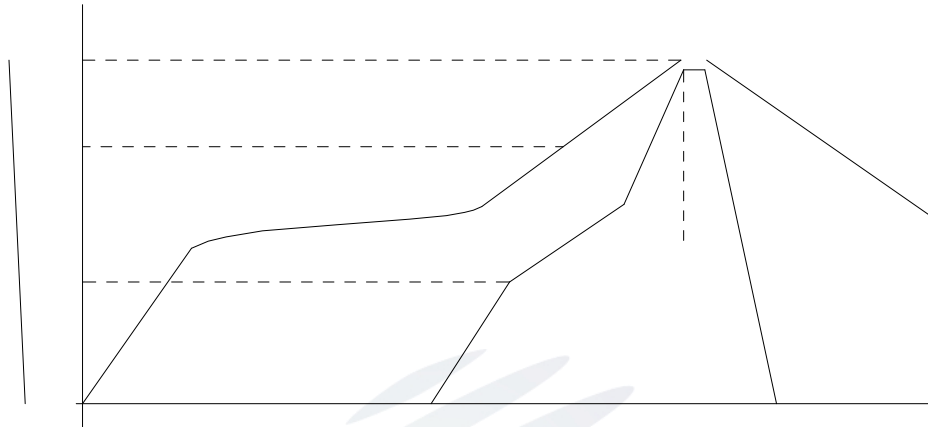

Fig.3-1SMT Reflow Soldering Instructions SMT

Table 3-1Parameter

Average temperature rise speed	Tsmx TP	3 °C/ Max 3 °C/ s
Preheating: minimum temperature	(Tsm)	150 °C
Preheating: Max temperature	(Tsmx)	200 °C
Preheating: Time	Tsm Tsmx	60 - 120 60s-120s
Time limited to maintain high temperature: the temperature		217 °C
Time limited to maintain high temperature: The Time	(tL)	60 - 150 60s-150s
Peak /Classification of temperature:	/ (TP)	260 °C
Time limit classification of peak temperature time	tp	10 Max 10s
Hold time within 5 °C with the actual peak temperature (TP)		30 Max 30s
(TP) 5 °C		
Cooling speed		6 °C/ Max 6 °C/ s
Needed time from 25 °C to Tp25 °C		8 Max 8 minutes

Notes

(1)Reflow soldering should not be done more than twice. If more than 24 hours be



(1) LED operating environment and sulfur element composition cannot be over 100PPM in the LED mating usage material. This is provided for informational purposes only and is not a warranty or endorsement. LED

(2) In order to prevent external material from getting into the inside of LED, which may cause the malfunction of LED, the single content of Bromine element is required to be less than 900PPM, the single content of Chlorine element is required to be less than 900PPM, the total content of Bromine element and Chlorine element in the external materials of the application products is required to be less than 1500PPM. This is provided for informational purposes only and is not a warranty or endorsement.

(3) VOCs (Volatile organic compounds) emitted from materials used in the construction of fixtures can penetrate silicone encapsulants of LEDs and discolor when exposed to heat and photonic energy. The result can be a significant loss of light output from the fixture. Knowledge of the properties of the materials selected to be used in the construction of fixtures can help prevent these issues. Refond advises against the use of any chemicals or materials that have been found or are suspected to have an adverse effect on device performance or reliability. To verify compatibility, Refond recommends that all chemicals and materials be tested in the specific application and environment for which they are intended to be used. Attaching LEDs, do not use adhesives that outgas organic vapor.

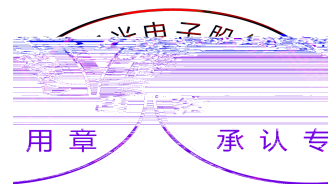

(4) In designing a circuit, the current through each LED must not exceed the absolute maximum rating specified for each LED. In the meanwhile, resistors for protection should be applied, otherwise slight voltage shift will cause big current change, burn out may happen. The driving circuit must be designed to allow forward voltage only when it is ON or OFF. If the reverse voltage is applied to LED, migration can be generated resulting in LED damage.

(5) Thermal Design is paramount importance because heat generation may result in the Characteristics decline, such as brightness decreased, Color change and so on. Please consider the heat generation of the LEDs when making the system design. LED

(6) Storage

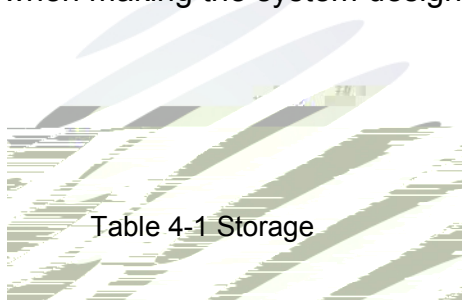

Table 4-1 Storage

Conditions		Temperature	Humidity	Time
Storage	Before Opening Aluminum Bag	≤30	≤75%	Within 1 Year from Delivery Date
	After Opening Aluminum Bag	≤30	≤60%	168hours 168
Baking		60±5	-	≥24hours 24

(7) If the moisture absorbent material silica gel has faded away or the LEDs have exceeded the storage time baking treatment should be performed after unpacking and based on the following condition 60 ± 5 for above 24 hours.

(8) If the package is flatulence or damaged, please notify the sales staff to assist.



(9) Similar to most Solid state devices; LEDs are sensitive to Electro-Static Discharge (ESD) and Electrical Over Stress (EOS).

(10) Other points for attention, please refer to our relevant information.

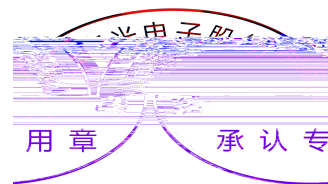

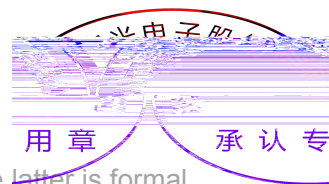

Declare

This specification is written both in English and in Chinese and the latter is formal.