

REFOND P/N

RF-OUL150TS-CA-E1

REFOND
Mass Product



Contents

- 1. Description
 - 1.1 General Description
 - 1.2 Features
 - 1.3 Application
 - 1.4 Package Dimension
 - 1.5 Product Parameters
 - 1.6 Typical optical characteristics curves
- 2. Packaging
 - 2.1 Packaging Specification
 - 2.1.1 Carrier Tape Dimension
 - 2.1.2 Reel Dimension
 - 2.1.3 Label Form Specification
 - 2.2 Moisture Resistant Packing
 - 2.3 Cardboard Box
 - 2.4 Reliability Test Items And Conditions
 - 2.5 Criteria For Judging Damage
- 3. SMT Reflow Soldering Instructions SMT
 - 3.1 SMT Reflow Soldering Instructions SMT
- 4. Handling Precautions
 - 4.1 Handling Precautions

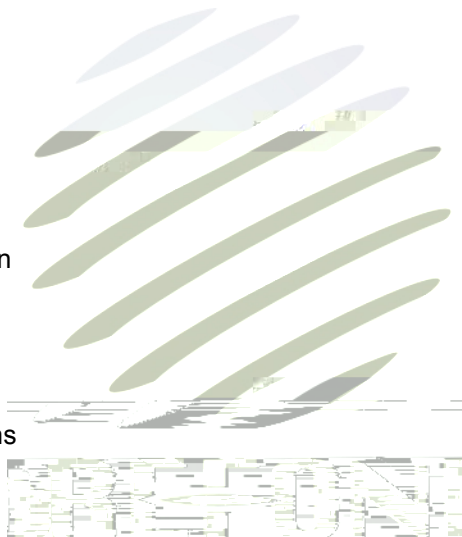

TheColourLED which was fabricated using a orange chip Package Dimension :
3.2mmX1.6mmX1.88mm.

LED

3.2mmX1.6mmX1.88mm

- ▶ Narrow viewing angle.
- ▶ Suitable for all SMT assembly and solder process.
- ▶ Moisture sensitivity level: Level 3.
- ▶ RoHS compliant.
- ▶ Optical indicator.
- ▶ Switch and Symbol, Display.
- ▶ General use.

SMT

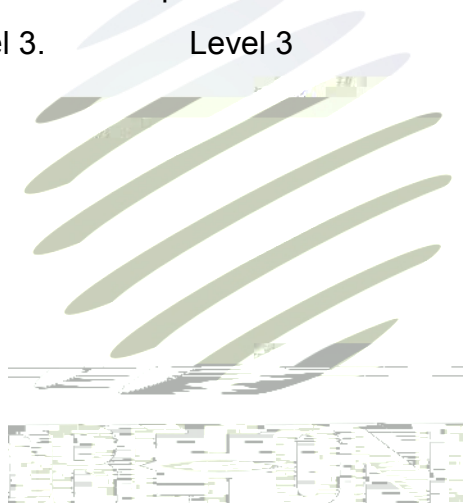

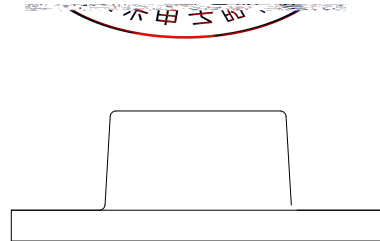

Fig.1-2 Side view

Fig.1-1 Top view

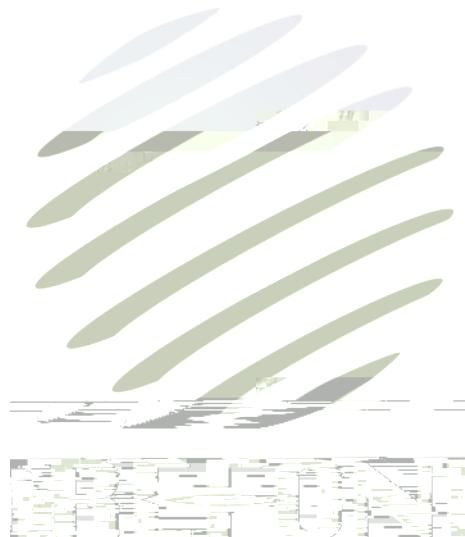

Fig.1-3 Bottom view

Fig.1-4 Polarity

Fig.1-5 Soldering patterns

Notes

All dimensions units are millimeters.

All dimensions tolerances are $\pm 0.2\text{mm}$ unless otherwise noted.

Table 1-1 Electrical / Optical Characteristics at Ts=25°C

	件	号				单位	
半							
压							
主			E00	620	--	625	nm
			F00	625	--	630	nm
发光				1200	--	1800	mcd
				1800	--	2800	mcd
				2800	--	4300	mcd
						μ	
						°C	

Note :V_R=5V For test conditions.V_R=5V

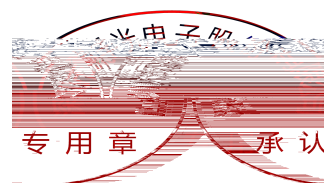
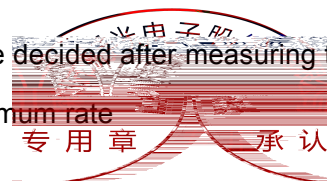

Table 1-2 Absolute Maximum Ratings at Ts=25°C

Parameter	Symbol	Rating	Units
Power Dissipation	P_d	69	mW
Forward Current	I_F	30	mA
Peak Forward Current Of Pulse	I_{FP}	60	mA
Electrostatic Discharge (HBM)	E_{SD}	2000	V
Operating Temperature	T_{opr}	-40 ~ +85	
Storage Temperature	T_{stg}	-40 ~ +85	
Junction Temperature	T_j	95	

Notes

- 1/10 Duty cycle, 0.1ms pulse width.
- The above forward voltage measurement allowance tolerance is $\pm 0.1V$.
- The above dominant wavelength measurement allowance tolerance is 2nm.
- The above luminous intensity measurement allowance tolerance $\pm 10\%$.
- Care is to be taken that power dissipation does not exceed the absolute maximum rating of the product.
- All measurements were made under the standardized environment of Refond.
- When the LEDs are in operation the maximum current should be decided after measuring the package temperature junction temperature should not exceed the maximum rate



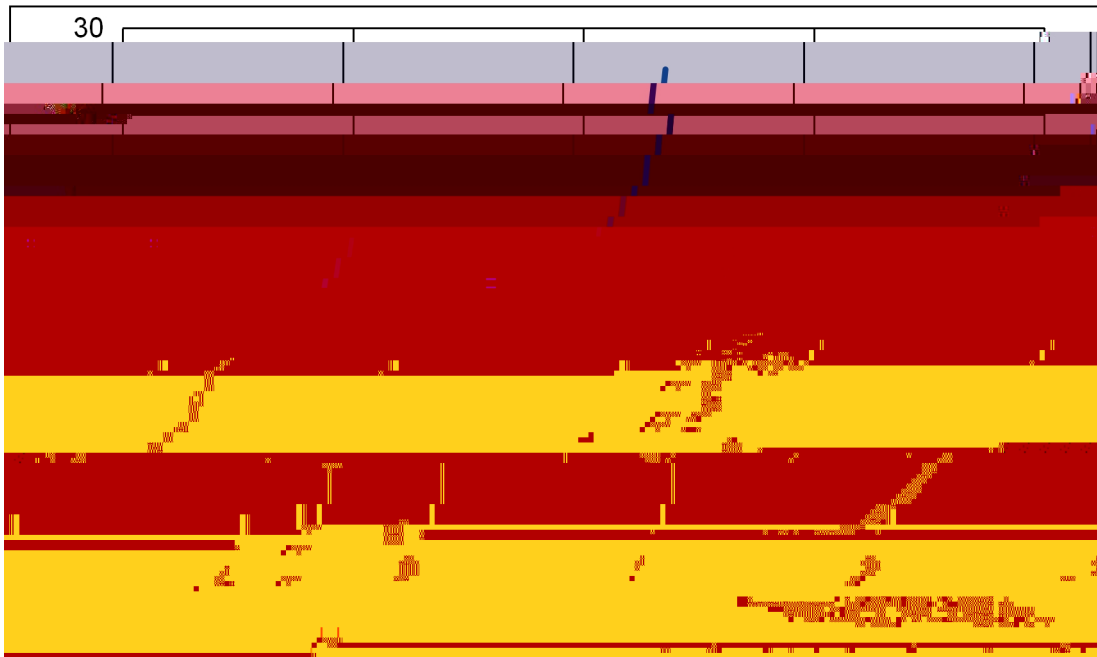

Fig 1-6 Forward Voltage Vs. Forward Current

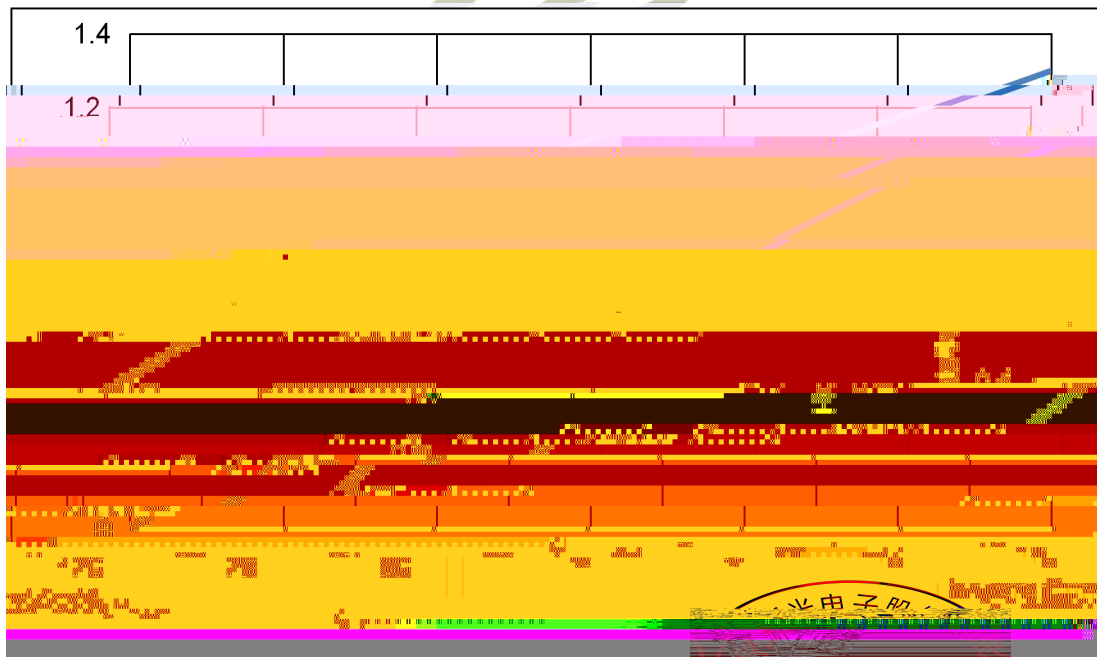
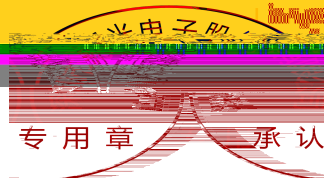

Fig 1-7 Forward Current Vs. Relative Intensity



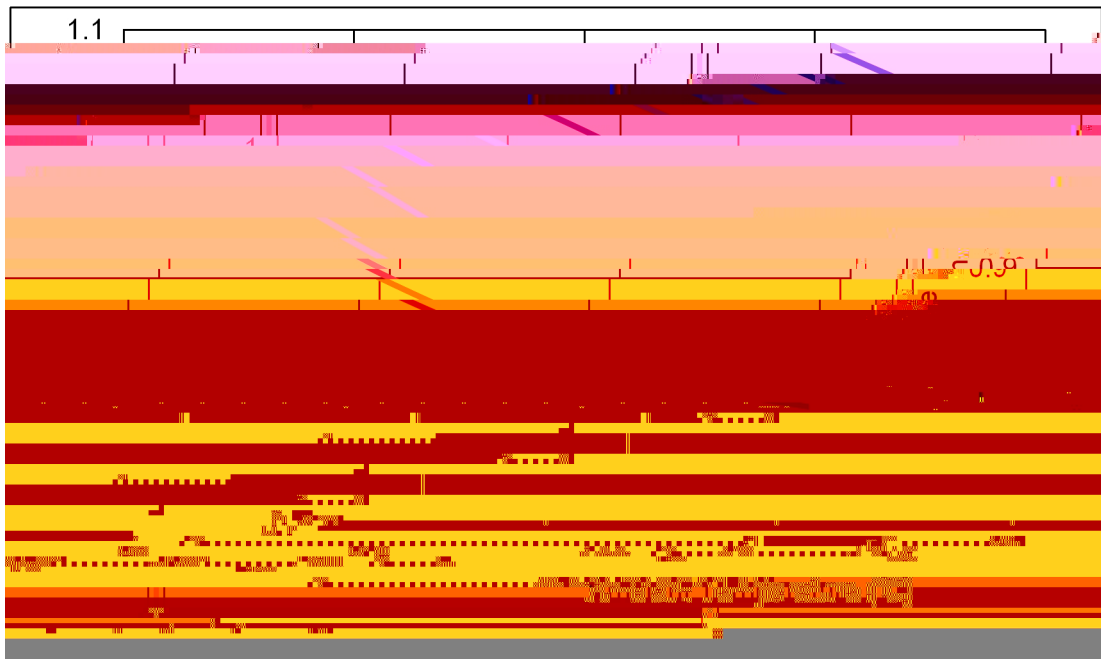

Fig 1-8 Solder Temperature Vs Relative Intensity

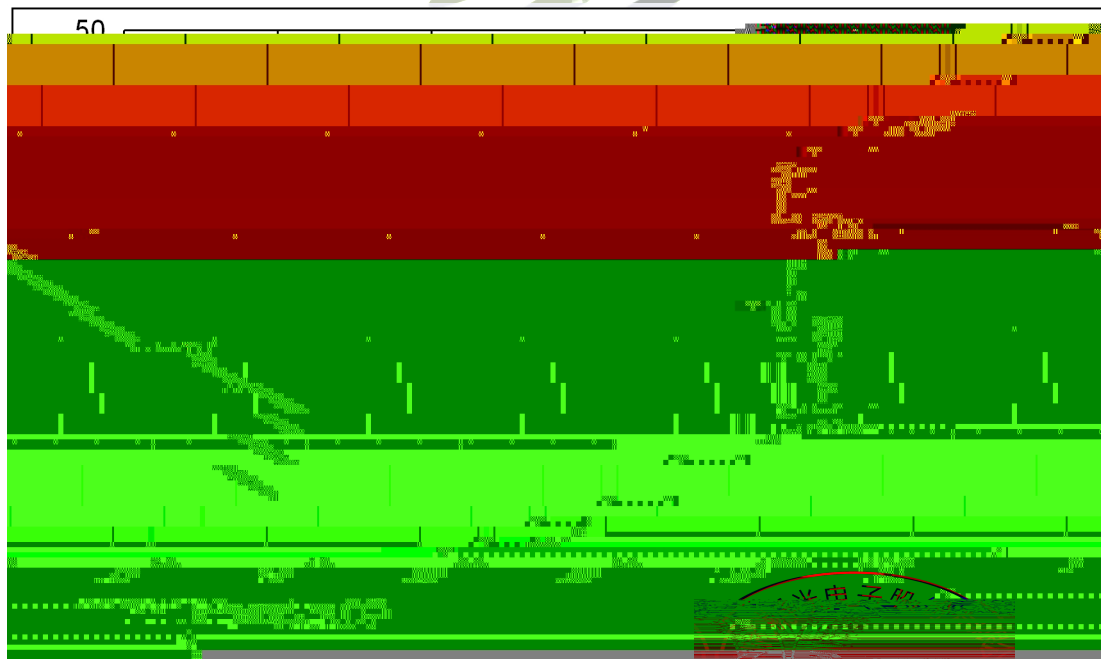
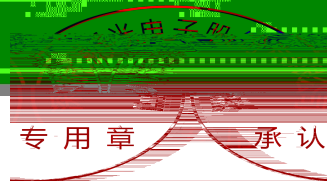

Fig 1-9 Solder Temperature Vs Forward Current



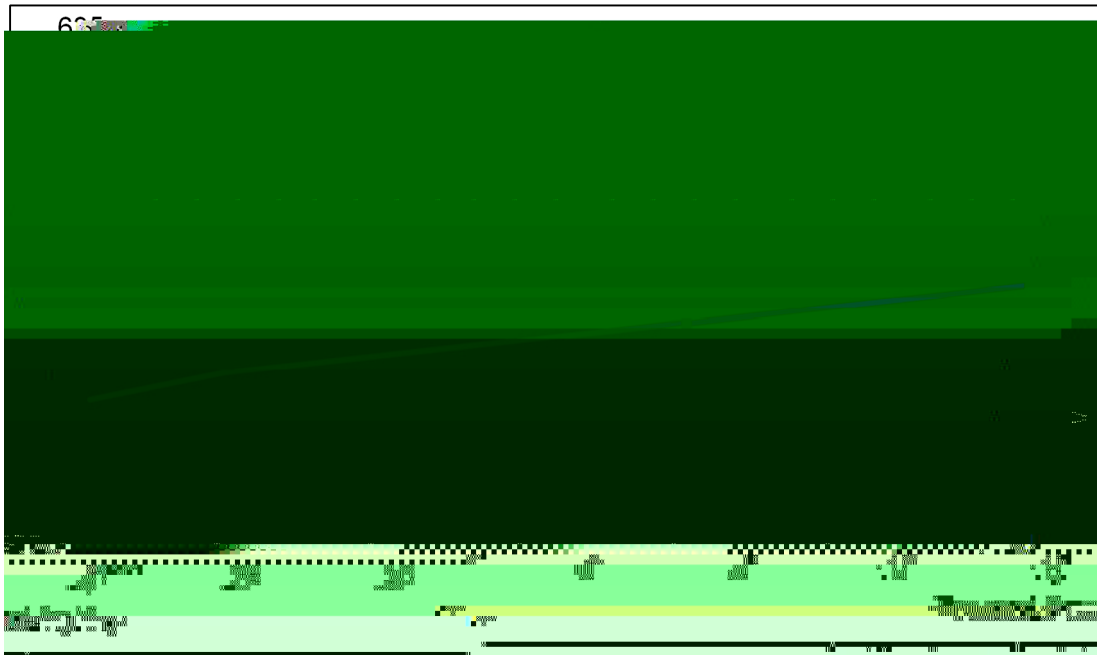

Fig.1-10 Forward Current Vs. Dominate Wavelength (Ta=25°C)

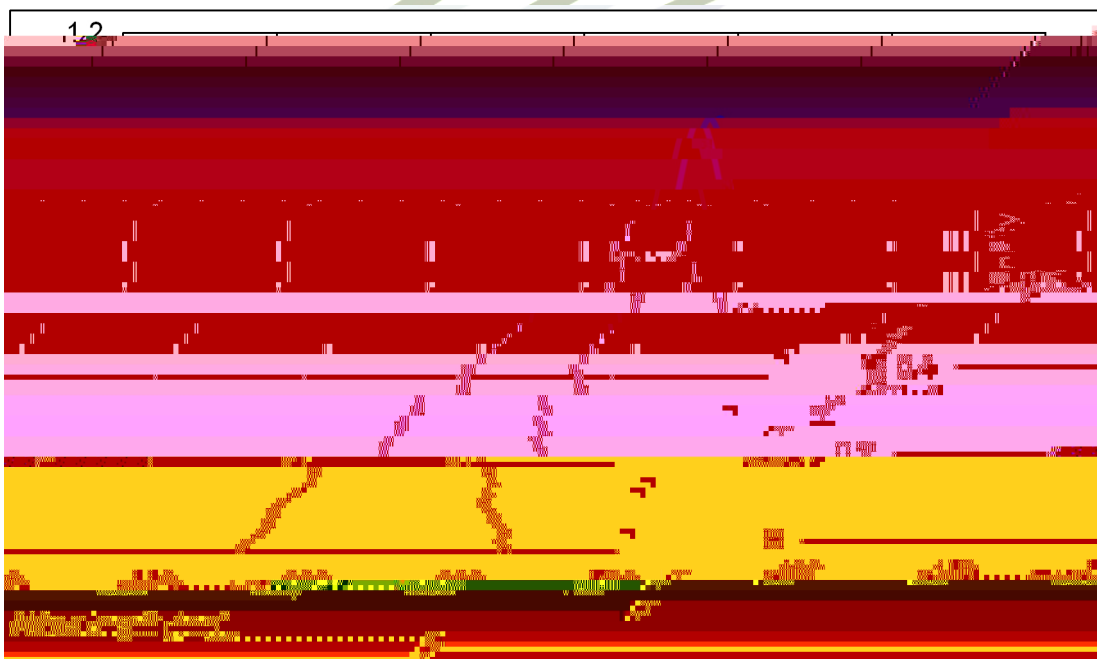
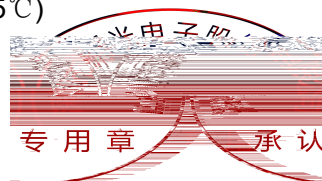

Fig.1-11 Relative Intensity Vs. Wavelength (Ta=25°C)



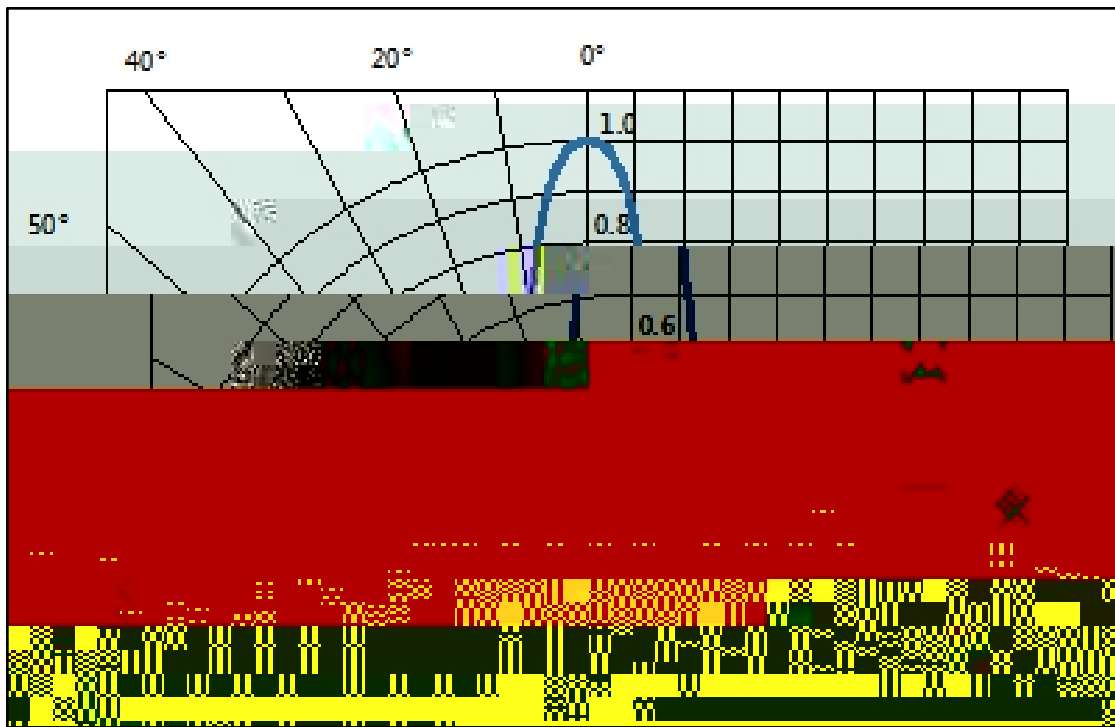
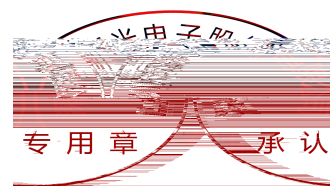

Fig.1-12 Diagram characteristics of radiation



Package:2000pcs/reel.

2000pcs

Carrier Tape Dimension

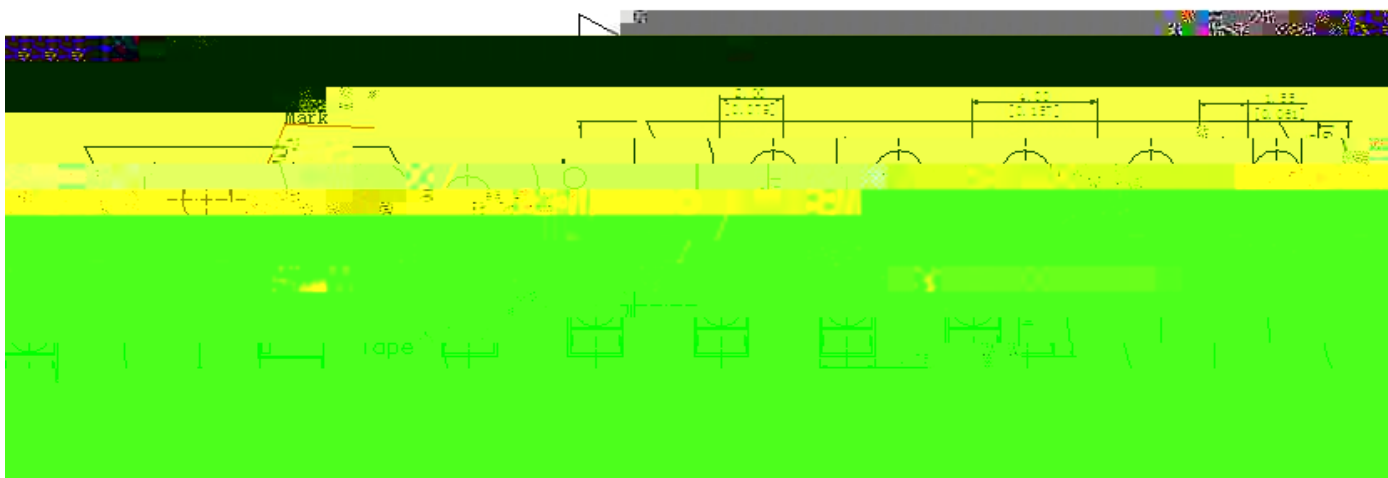

Fig.2-1 Carrier Tape Dimension

2.1.2 Reel Dimension

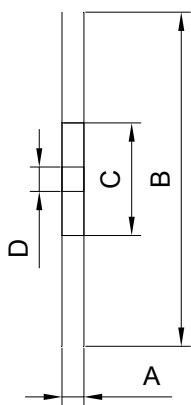
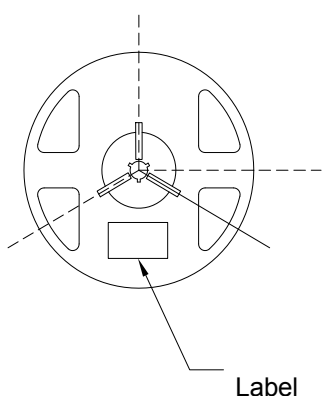
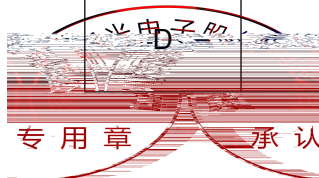

Table 2-1 Dimension

A	8.0 0.1mm
B	178 1mm
C	60 1mm
D	13.0 0.5mm

Fig 2-2 Reel Dimension

Notes The tolerances unless mentioned ± 0.1 mm. Unit : mm
 ± 0.1



2.1.3 Label Form Specification

Table 2-2 Parameter

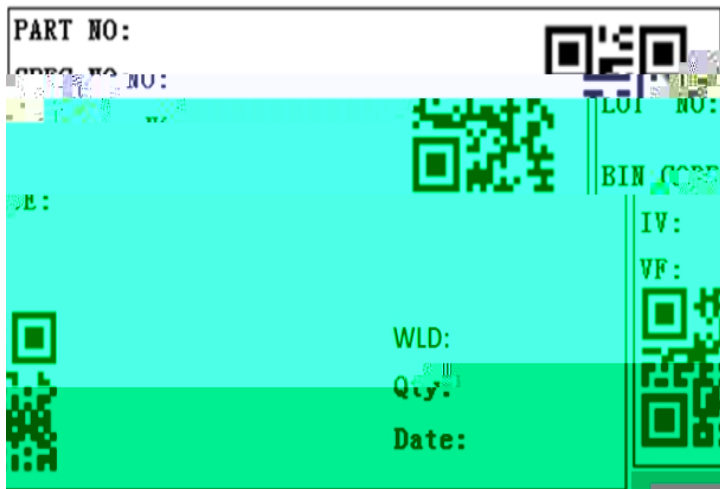

PART NO.	Part Number
SPEC NO.	Spec Number
LOT NO.	Lot Number
BIN CODE	Bin Code
Φ	Luminous flux
XY	Chromaticity Bin
V_F	Forward Voltage
WLD	Wavelength
QTY	Packing Quantity
DATE	Made Date

Fig 2-3 Label Form Specification

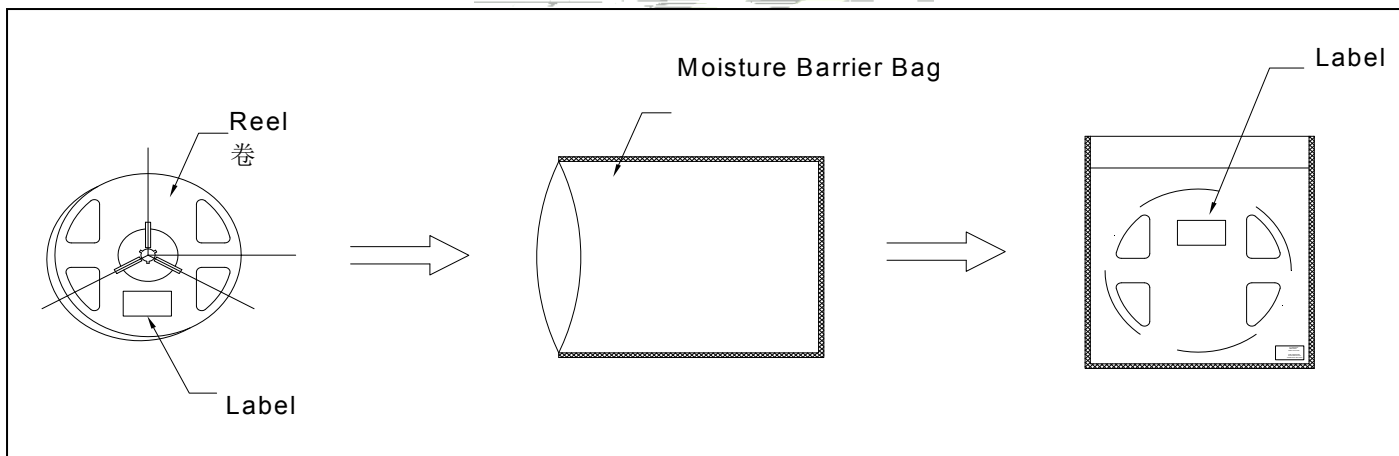
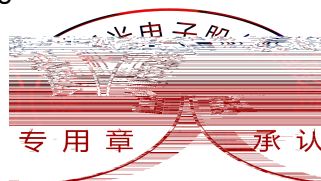

Fig 2-4 Moisture Resistant Packing



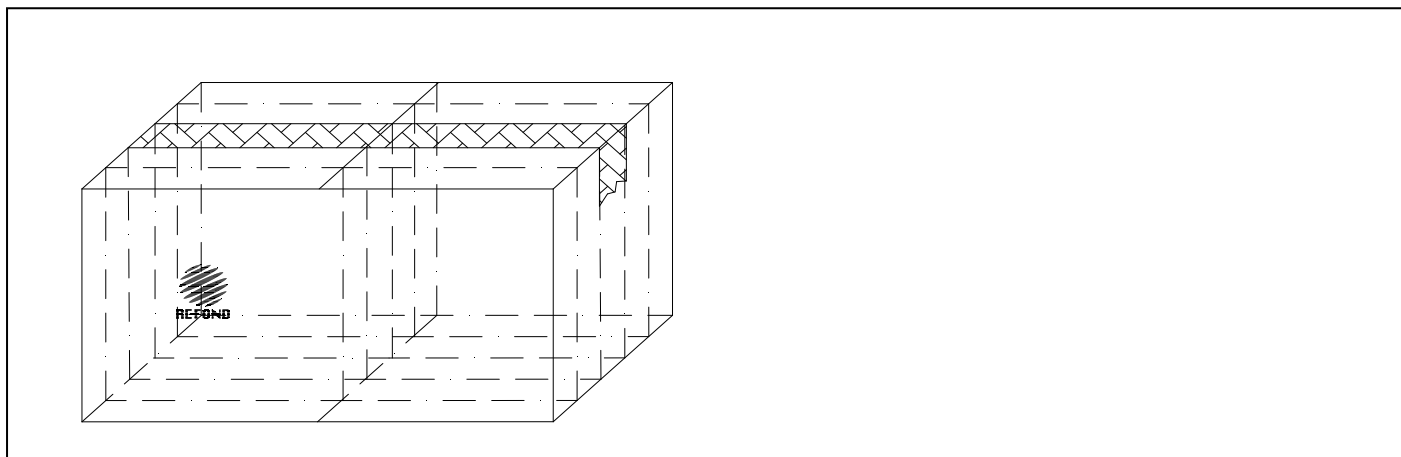

Fig 2-5 Cardboard Box

Table 2-3 Reliability Test Items And Conditions

Test Items	Ref.Standard	Test Condition	Time	Quantity	Ac/Re /
Reflow	JESD22-B106	Temp:260 max T=10 sec	2 times	22Pcs	0/1
Temperature Cycle	JESD22-A104	-100 30 min ↑↓5 min -40 30 min	100 cycles	22Pcs	0/1
Thermal Shock	JESD22-A106	-40 15min ↑↓ 100 15min	300 cycles	22Pcs	0/1
High Temperature Storage	JESD22-A103	Temp:100	1000 hrs	22Pcs	0/1
Low Temperature Storage	JESD22-A119	Temp:-40	1000 hrs	22Pcs	0/1
Life Test	JESD22-A108	T _a =25 I _F =20mA	1000 hrs	22Pcs	0/1

Table 2-4 Criteria For Judging Damage

Test Items	Symbol	Test Condition	Criteria For Judgement	
			Min.	Max.
Forward Voltage	V_F	$I_F=20\text{mA}$	-	U.S.L*)x1.1
Reverse Current	I_R	$V_R= 5\text{V}$	-	U.S.L*)x2.0
Luminous Flux	Φ	$I_F=20\text{mA}$	L.S.L*)x0.7	-

Notes

1.U.S.L: Upper standard level

L.S.L: Lower standard level

2.The above reliability tests is based on the verification of a single/strip LED of Refond's existing experimental platform,the reliability experiment was taken under good heat dissipation conditions. When customers applies the LED to the series and parallel circuit,should take consideration of all the factors such as the current, voltage distribution, heat dissipation and others.

3.The technical information shown in the data sheets is limited to the typical characteristics and circuit examples of the referenced products. It does not constitute the warranting of industrial property nor the granting of any license.



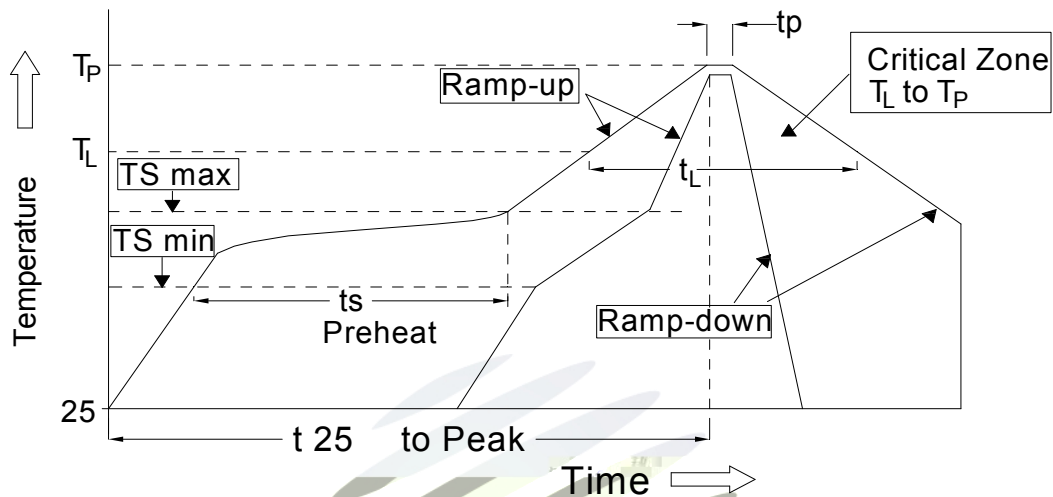

Fig.3-1SMT Reflow Soldering Instructions SMT

Table 3-1Parameter

Average temperature rise speed	T_{smax} T_P	3 °C/ s	Max 3 °C/ s
Preheating: minimum temperature	(T_{smin})	150 °C	
Preheating: Max temperature	(T_{smax})	200 °C	
Preheating: Time	T_{smin} T_{smax}	60 - 120	60s-120s
Time limited to maintain high temperature: the temperature		217 °C	
Time limited to maintain high temperature: The Time	(t_L)	60 - 150	60s-150s
Peak /Classification of temperature:	(T_P)	260 °C	
Time limit classification of peak temperature time	t_p	10	Max 10s
Hold time within 5 °C with the actual peak temperature (T_P)	(T_P) 5 °C	30	Max 30s
Cooling speed		6 °C/ s	Max 6 °C/ s
Needed time from 25 °C to T_p 25 °C			Max 8 minutes

Notes

(1)Reflow soldering should not be done more than twice. If more than 24 hours between the two solderings , LED will be damaged.

(2)When soldering , do not put stress on the LEDs during heating.

3.1.1 Soldering Iron

(1) When do soldering by hand, keep the temperature of iron below less 300 less than 3 seconds.

(2) Soldering by hand should be done only one time.

3.1.2 Repairing

Repairing should not be done after the LEDs have been soldered. When repairing is unavoidable,a double-head soldering iron should be used (as below figure). It should be confirmed in advance whether the characteristics of LEDs will or not be damaged by repairing.

LED



3.1.3 Cautions

(1)Components should not be mounted on warped (non coplanar) portion of PCB. After soldering, do not warp the circuit board.LED

(2) Do not apply mechanical force or excess vibration during the cooling process to normal temperature after soldering. Do not rapidly cool device after soldering.

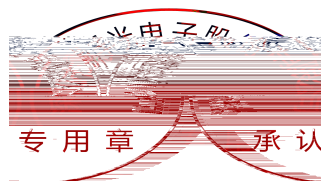

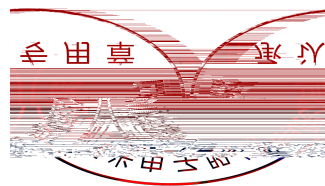

(1) LE

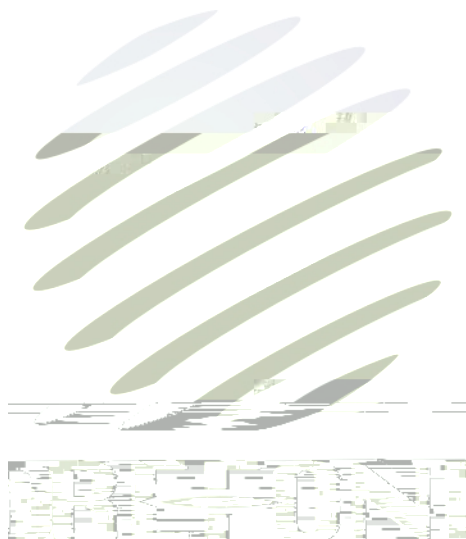

(4) In designing a circuit, the current through each LED must not exceed the absolute maximum rating specified for each LED. In the meanwhile, resistors for protection should be applied, otherwise slight voltage shift will cause big current change, burn out may happen. The driving circuit must be designed to allow forward voltage only when it is ON or OFF. If the reverse voltage is applied to LED, migration can be generated resulting in LED damage.

(5) Thermal Design is paramount importance because heat generation may result in the Characteristics decline, such as brightness decreased, Color change and so on. Please consider the heat generation of the LEDs when making the system design. LED

(6) Storage

Table 4-1 Storage

Conditions		Temperature	Humidity	Time
Storage	Before Opening Aluminum Bag	≤30℃	≤75%	Within 1 Year from Delivery Date
	After Opening Aluminum Bag	≤30℃	≤60%	168hours 168
Baking		60±5℃	-	≥24hours 24

(7) If the moisture absorbent material silica gel has faded away or the LEDs have exceeded the storage time baking treatment should be performed after unpacking and based on the following condition 60 5 for above 24 hours.

(8) If the package is flatulence or damaged, please notify the sales staff to assist.



(9) Similar to most Solid state devices; LEDs are sensitive to Electro-Static Discharge (ESD) and Electrical Over Stress (EOS).

(10) Other points for attention, please refer to our relevant information.

