

Contents

- 1. Description
 - 1.1 General Description
 - 1.2 Features
 - 1.3 Application
 - 1.4 Package Dimension
 - 1.5 Product Parameters
 - 1.6 Typical optical characteristics curves
- 2. Packaging
 - 2.1 Packaging Specification
 - 2.1.1 Carrier Tape Dimension
 - 2.1.2 Reel Dimension
 - 2.1.3 Label Form Specification
 - 2.2 Moisture Resistant Packing
 - 2.3 Cardboard Box
 - 2.4 Reliability Test Items And Conditions
 - 2.5 Criteria For Judging Damage
- 3. SMT Reflow Soldering Instructions SMT
 - 3.1 SMT Reflow Soldering Instructions SMT
- 4. Handling Precautions
 - 4.1 Handling Precautions



The ColourLED which was fabricated using a amber chip Package Dimension :
3.2mmX1.6mmX1.88mm.

LED

3.2mmX1.6mmX1.88mm

- ▶ Narrow viewing angle.
- ▶ Suitable for all SMT assembly and solder process.
- ▶ Moisture sensitivity level: Level 3.
- ▶ RoHS compliant.

SMT

Level 3

RoHS

- ▶ Optical indicator.
- ▶ Switch and Symbol, Display.
- ▶ General use.

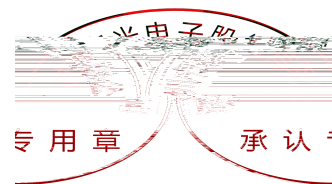
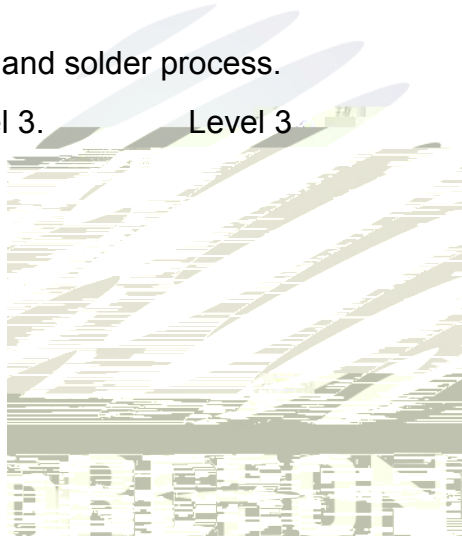

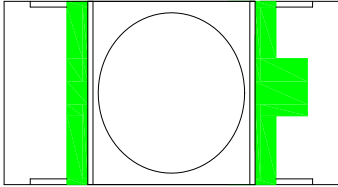

Fig.1-1 Top view

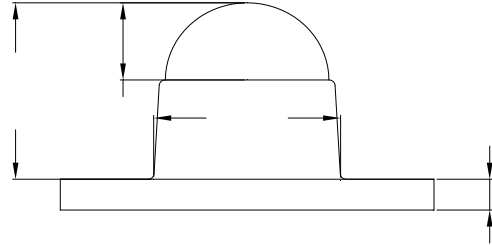

Fig.1-2 Side view



Fig.1-3 Bottom view

Fig.1-4 Polarity

Fig.1-5 Soldering patterns

Notes

All dimensions units are millimeters.

All dimensions tolerances are $\pm 0.2\text{mm}$ unless otherwise noted.

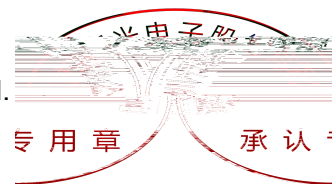

Table 1-1 Electrical / Optical Characteristics at Ts=25°C

	A					
F	A		B			
			C			
			D			
D	A		A			
			B			
			C			
	A					
	A					D
						μA
	A					

Note : $V_R=5V$ For test conditions. $V_R=5V$



Table 1-2 Absolute Maximum Ratings at Ts=25°C

Parameter	Symbol	Rating	Units
Power Dissipation	P_d	72	mW
Forward Current	I_F	30	mA
Peak Forward Current Of Pulse	I_{FP}	60	mA
Electrostatic Discharge (HBM)	E_{SD}	2000	V
Operating Temperature	T_{opr}	-40 ~ +85	
Storage Temperature	T_{stg}	-40 ~ +85	
Junction Temperature	T_j	95	

Notes

- 1/10 Duty cycle, 0.1ms pulse width.
- The above forward voltage measurement allowance tolerance is $\pm 0.1V$.
- The above dominant wavelength measurement allowance tolerance is 2nm.
- The above luminous intensity measurement allowance tolerance $\pm 10\%$.
- Care is to be taken that power dissipation does not exceed the absolute maximum rating of the product.
- All measurements were made under the standardized environment of Refond.
- When the LEDs are in operation the maximum current should be decided after measuring the package temperature junction temperature should not exceed the maximum rate.

专用章 承认



Fig 1-6 Forward Voltage Vs. Forward Current

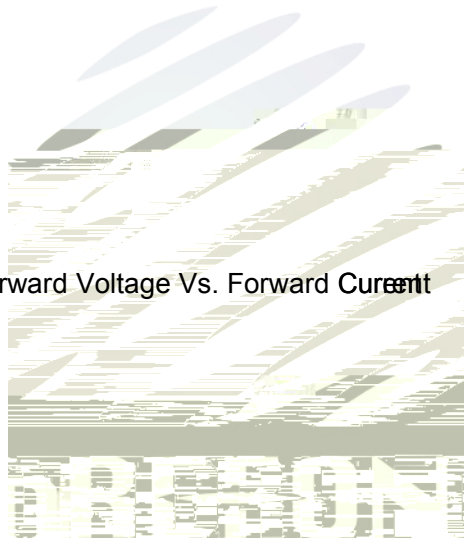

Fig 1

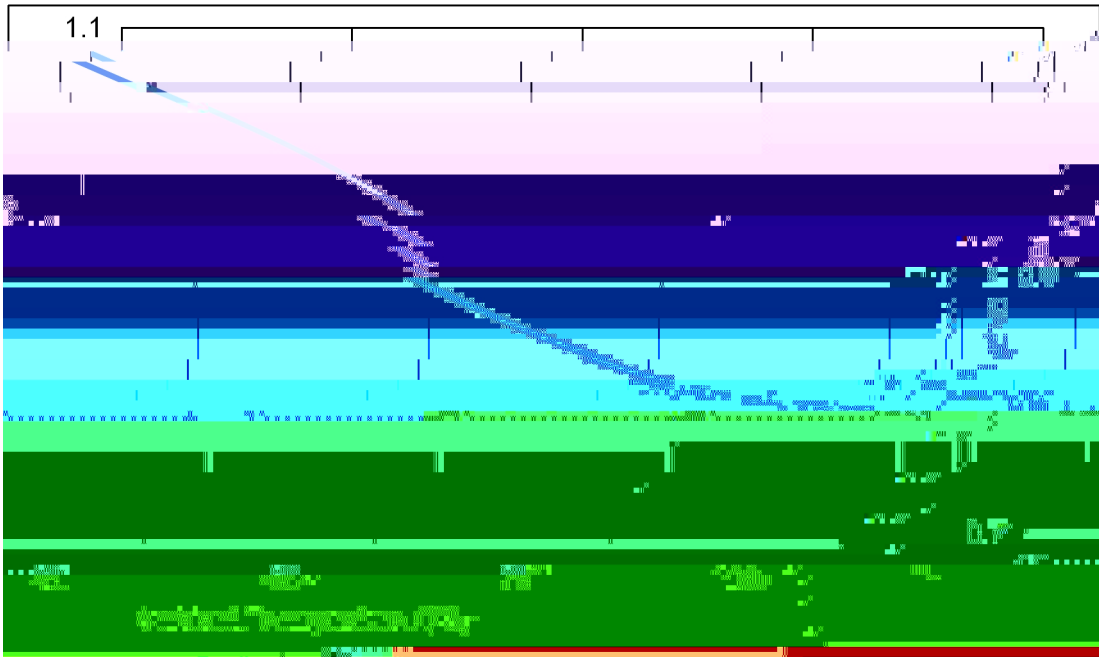

Fig 1-8 Solder Temperature Vs Relative Intensity

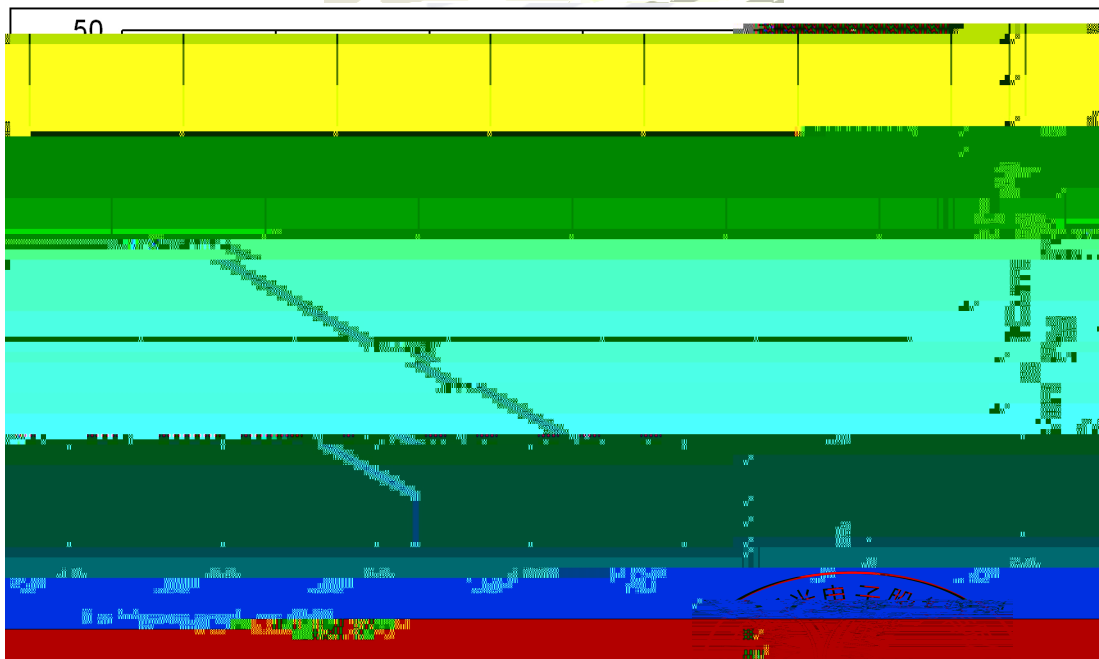
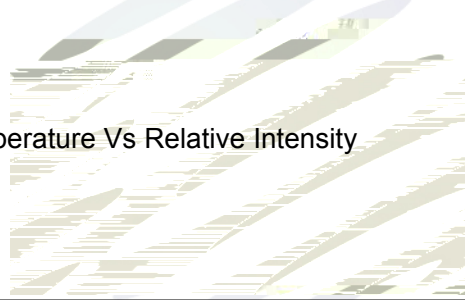

Fig 1-9 Solder Temperature Vs Forward Current

专用章 承认司

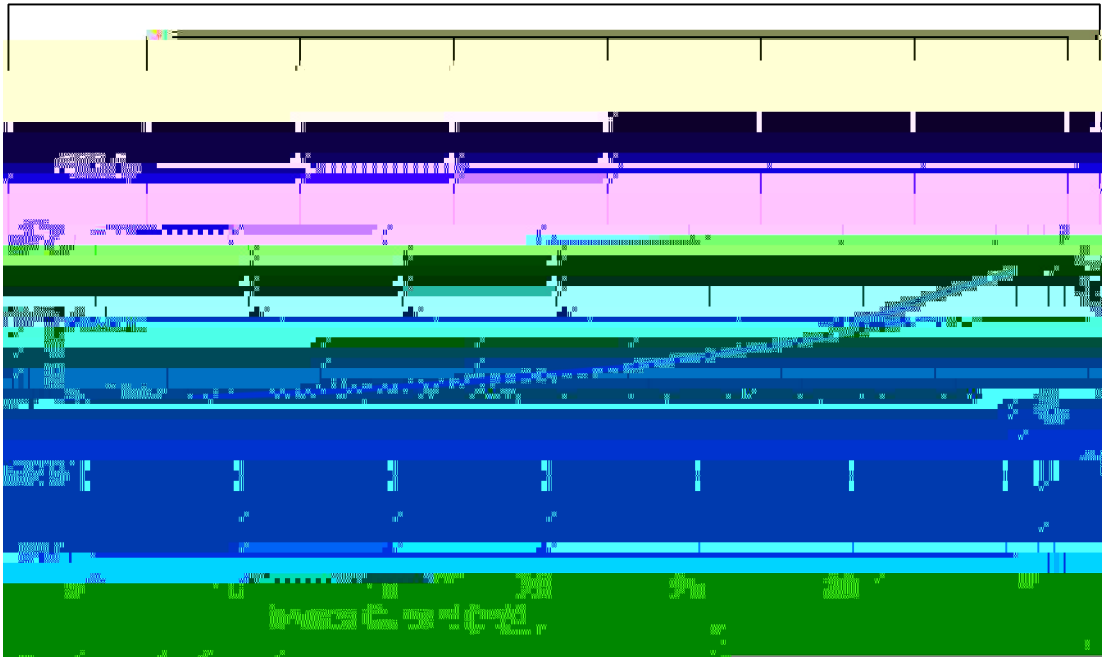

Fig.1-10 Forward Current Vs. Dominate Wavelength (Ta=25)

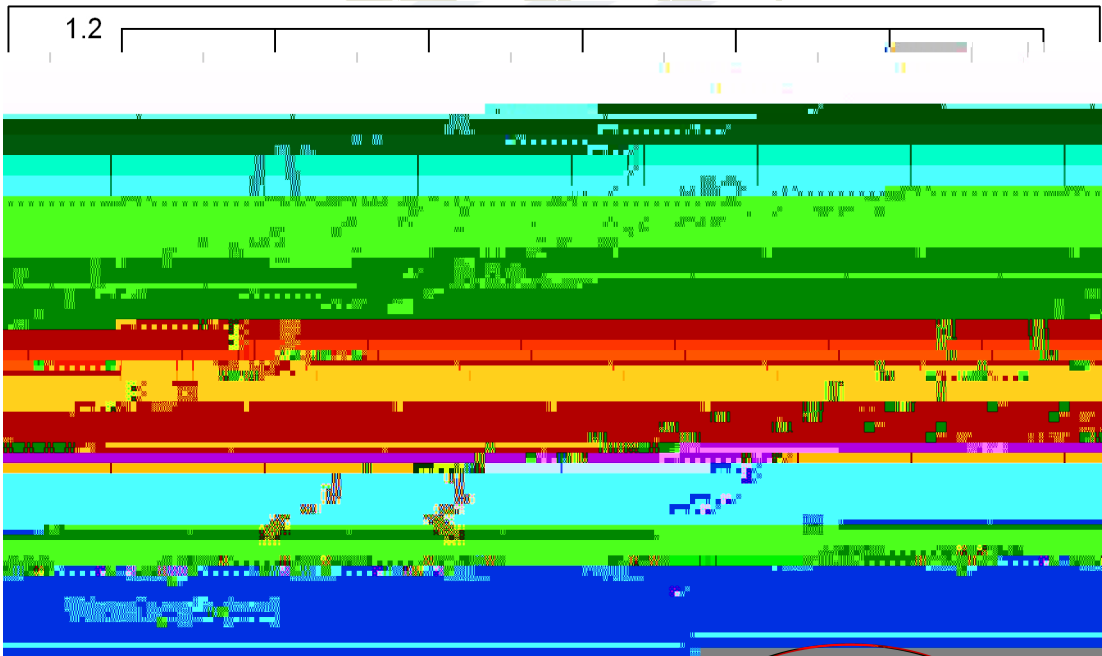
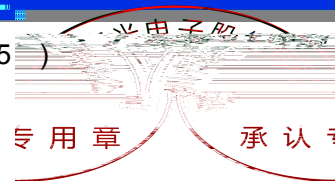

Fig.1-11 Relative Intensity Vs. Wavelength (Ta=25)



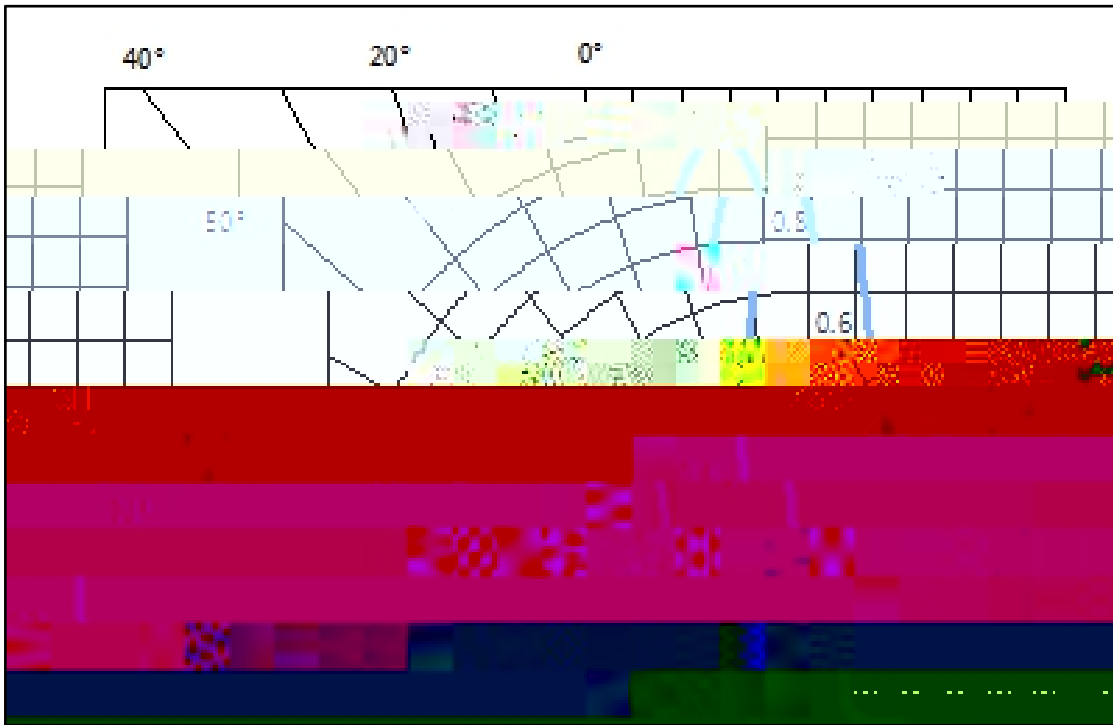
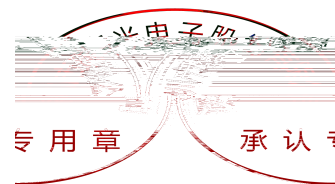
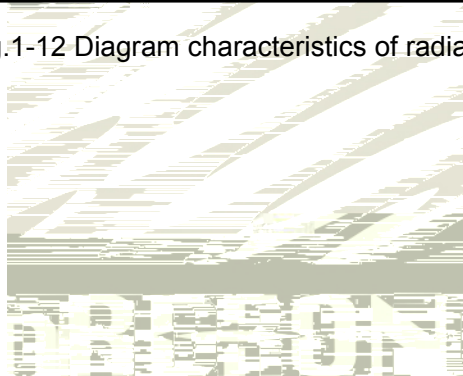

Fig.1-12 Diagram characteristics of radiation



Package:2000pcs/reel.

2000pcs

Carrier Tape Dimension

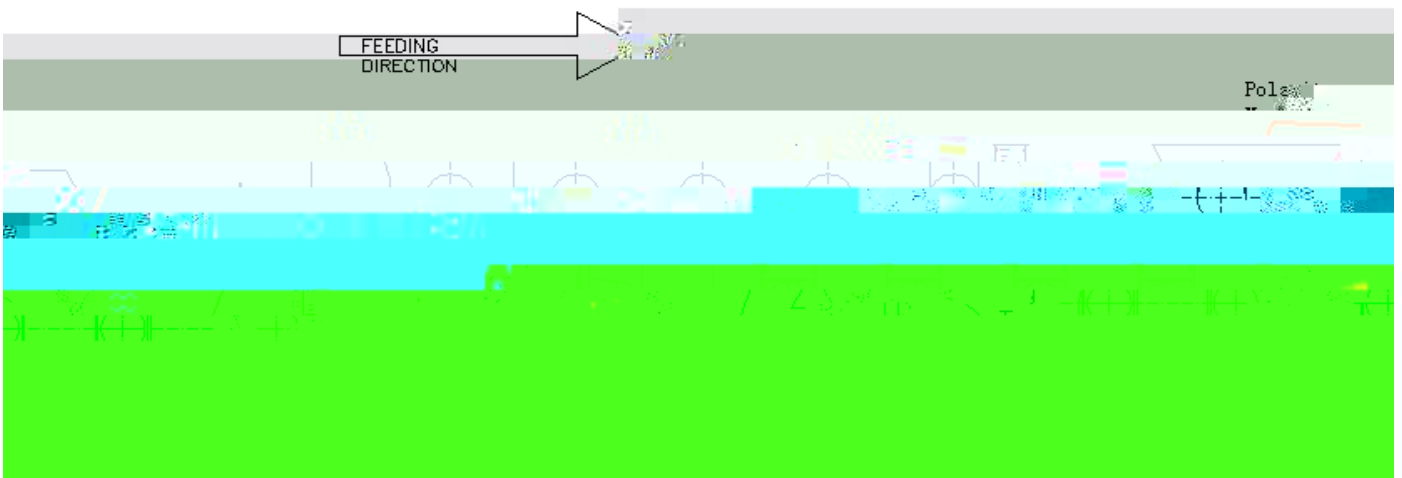

Fig.2-1 Carrier Tape Dimension

2.1.2 Reel Dimension

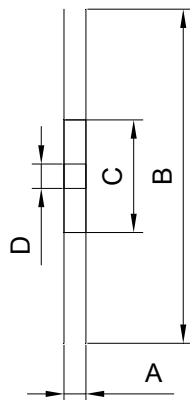
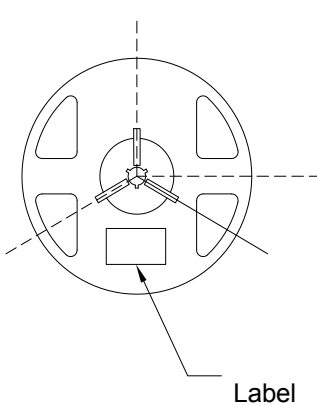
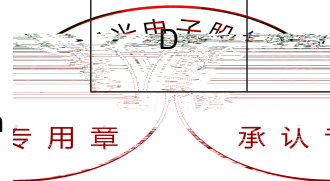

Fig 2-2 Reel Dimension

Table 2-1 Dimension

A	8.0 0.1mm
B	178 1mm
C	60 1mm
D	13.0 0.5mm

Notes The tolerances unless mentioned ± 0.1 mm. Unit : mm
 ± 0.1



2.1.3 Label Form Specification

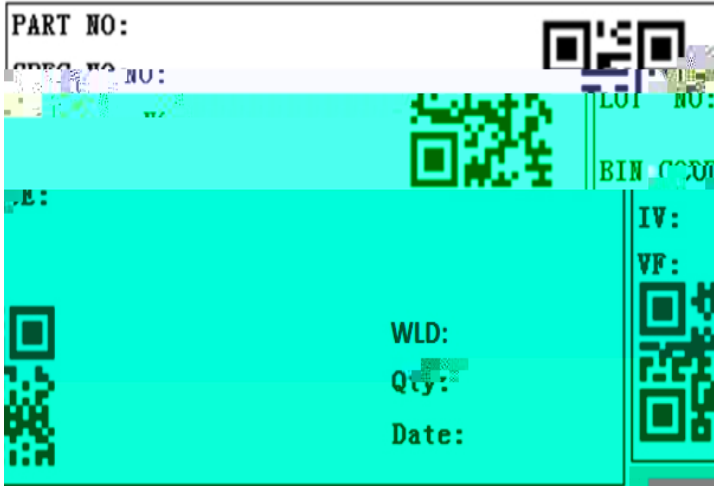

PART NO.	Part Number
SPEC NO.	Spec Number
LOT NO.	Lot Number
BIN CODE	Bin Code
Φ	Luminous flux
XY	Chromaticity Bin
V_F	Forward Voltage
WLD	Wavelength
QTY	Packing Quantity
DATE	Made Date

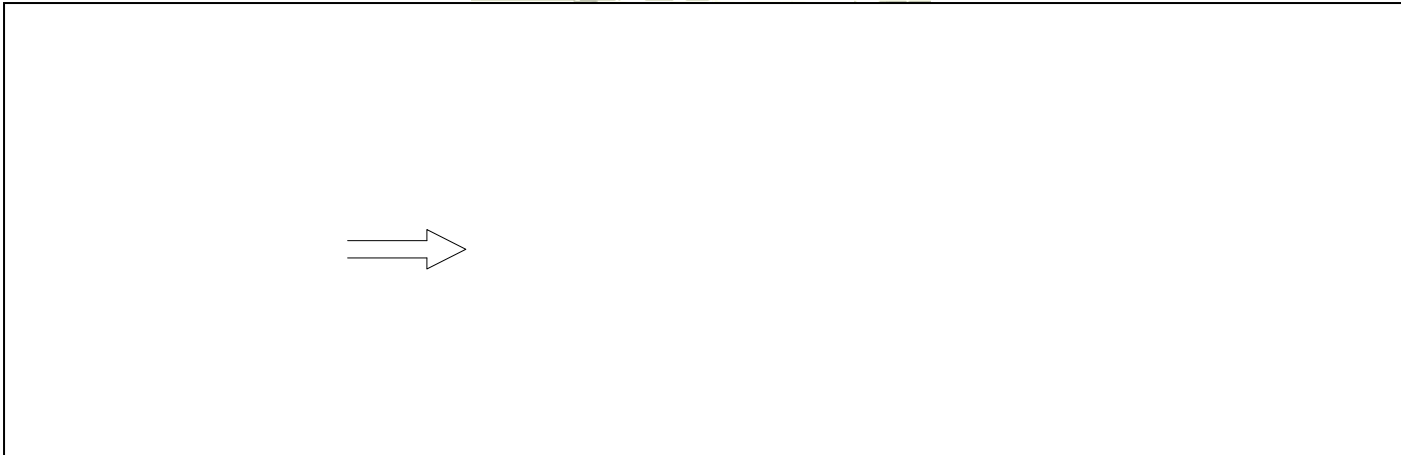

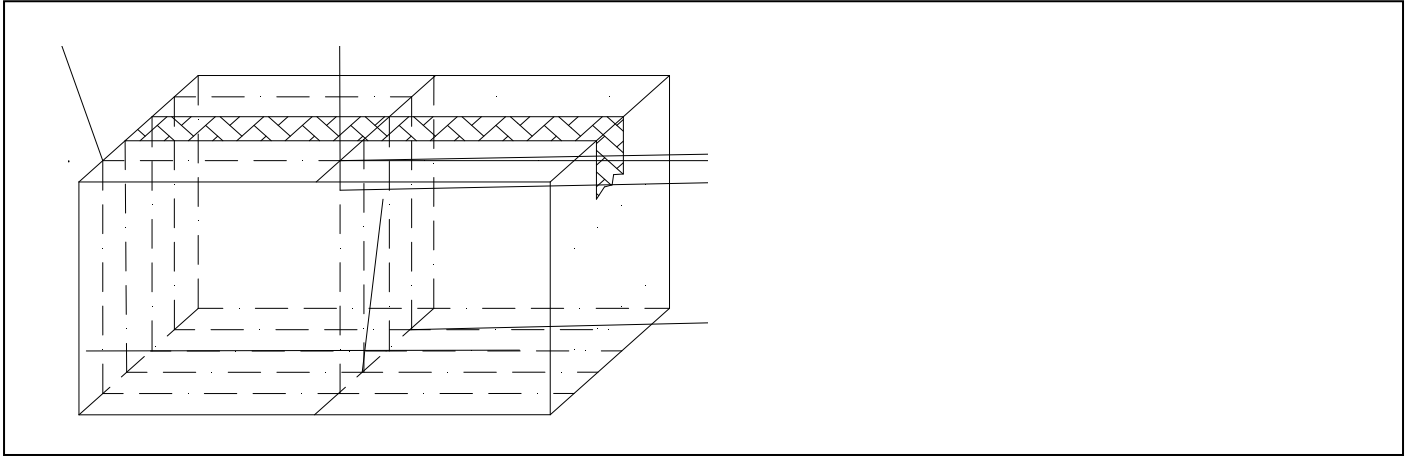

Fig 2-5 Cardboard Box

Table 2-3 Reliability Test Items And Conditions

Test Items	Ref.Standard	Test Condition	Time	Quantity	Ac/Re /
Reflow	JESD22-B106	Temp:260 max T=10 sec	2 times	22Pcs	0/1
Temperature Cycle	JESD22-A104	100 30 min ↑↓5 min -40 30 min	100 cycles	22Pcs	0/1
Thermal Shock	JESD22-A106	-40 15min ↑↓ 100 15min	300 cycles	22Pcs	0/1
High Temperature Storage	JESD22-A103	Temp:100	1000 hrs	22Pcs	0/1
Low Temperature Storage	JESD22-A119	Temp:-40	1000 hrs	22Pcs	0/1
Life Test	JESD22-A108	T _a =25 I _F =20mA	1000 hrs	22Pcs	0/1



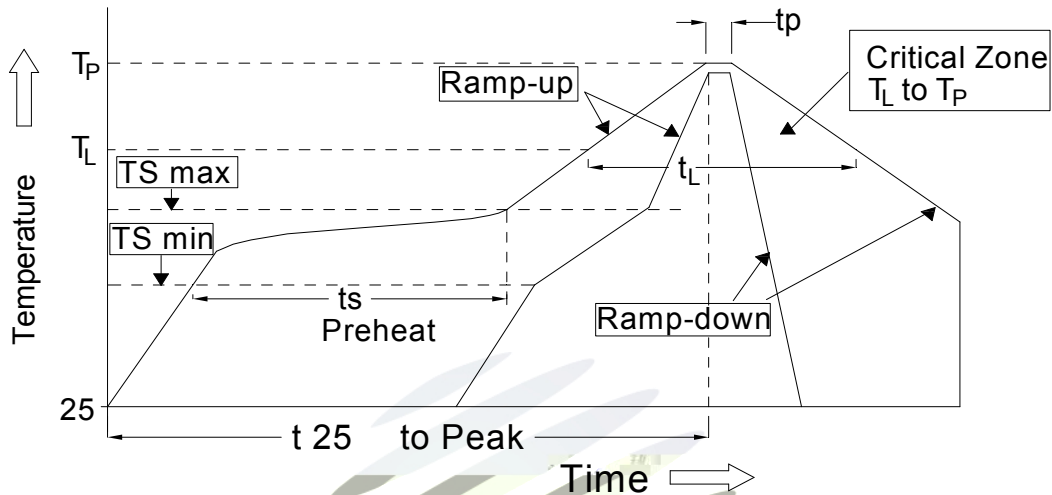

Fig.3-1SMT Reflow Soldering Instructions SMT

Table 3-1Parameter

Average temperature rise speed	Tsmax TP	3 °C/ Max 3 °C/ s
Preheating: minimum temperature	(Tssmin)	150 °C
Preheating: Max temperature	(Tssmax)	200 °C
Preheating: Time	Tssmin Tssmax	60 - 120 60s-120s
Time limited to maintain high temperature: the temperature		217 °C
Time limited to maintain high temperature: The Time	(tL)	60 - 150 60s-150s
Peak /Classification of temperature:	/ (TP)	260 °C
Time limit classification of peak temperature time	tp	10 Max 10s
Hold time within 5 °C with the actual peak temperature (TP)		30 Max 30s
(TP) 5 °C		
Cooling speed		6 °C/ Max 6 °C/ s
Needed time from 25 °C to Tp25 °C		Max 8 minutes

Notes

(1)Reflow soldering should not be done more than twice. If more than 24 hours between the two solderings , LED will be damaged.

(2)When soldering , do not put stress on the LEDs during heating.

3.1.1 Soldering Iron

(1) When do soldering by hand, keep the temperature of iron below less 300 less than 3 seconds

(2) Soldering by hand should be done only one time.

3.1.2 Repairing

Repairing should not be done after the LEDs have been soldered. When repairing is unavoidable,a double-head soldering iron should be used (as below figure). It should be confirmed in advance whether the characteristics of LEDs will or not be damaged by repairing.

LED

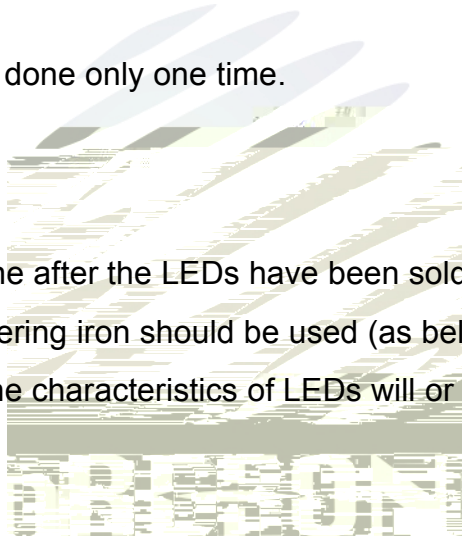

3.1.3 Cautions

(1)Components should not be mounted on warped (non coplanar) portion of PCB. After soldering, do not warp the circuit board.LED

(2) Do not apply mechanical force or excess vibration during the cooling process to normal temperature after soldering. Do not rapidly cool device after soldering.

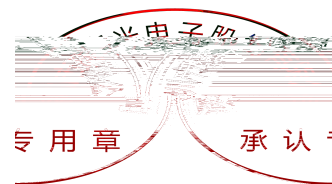

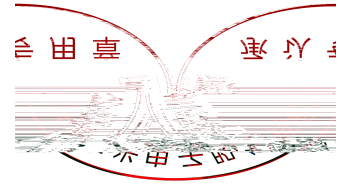

In order to ensure the reliability of the LED, the maximum current must not exceed the absolute maximum rating. If the current exceeds the maximum rating, the LED will be damaged. In order to protect the LED, a current limiting resistor should be connected in series with the LED. The current limiting resistor should be selected such that the current through the LED does not exceed the maximum rating. The current limiting resistor should be selected such that the current through the LED does not exceed the maximum rating. The current limiting resistor should be selected such that the current through the LED does not exceed the maximum rating.

(5) Thermal Design is of paramount importance because heat generation may result in LED failure.



④ 2 4 U

b w

REFC v.re GE:18

(9) Similar to most Solid state devices; LEDs are sensitive to Electro-Static Discharge (ESD) and Electrical Over Stress (EOS).

(10) Other points for attention, please refer to our relevant information.



