

SPECIFICATION

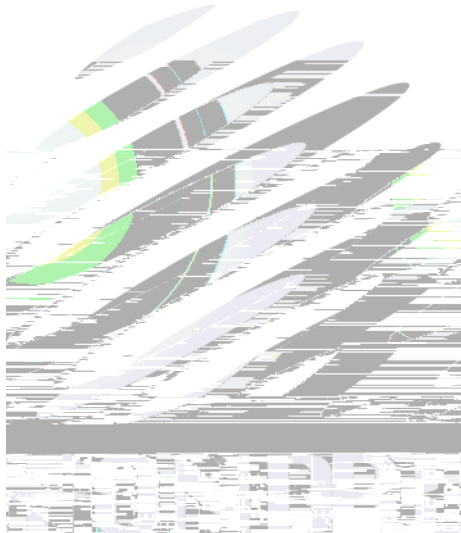

Contents

| | |
|--|---|
| 1. Description | 3 |
| 1.1 General Description | 3 |
| 1.2 Features | 3 |
| 1.3 Application | 3 |
| 1.4 Package Dimension | 4 |
| 1.5 Product Parameters | 5 |
| 1.6 Typical Optical Characteristics Curves | 7 |
| 2. Packaging | |



1. Description

1.1 General Description



The Colour LED which was fabricated using a green chip Package Dimension : 3.2mmX1.25mmX1.1mm.

LED

3.2mmX1.25mmX1.1mm

1.2 Features

Extremely wide viewing angle.

Suitable for all SMT assembly and solder process.

Moisture sensitivity level: Level 3.

RoHS compliant.

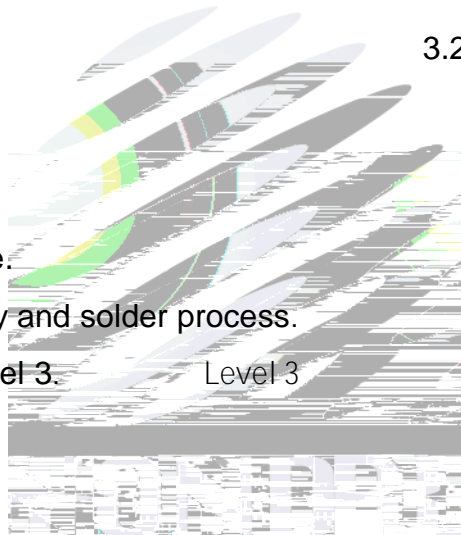

SMT

Level 3

1.3 Application

Optical indicator.

Switch and symbol, display.

General use.



1.4 Package Dimension

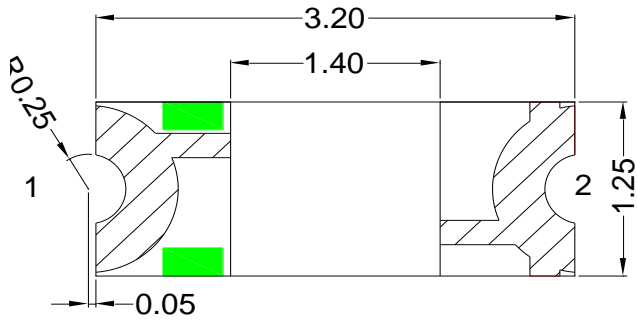

Fig.1-1 Top view

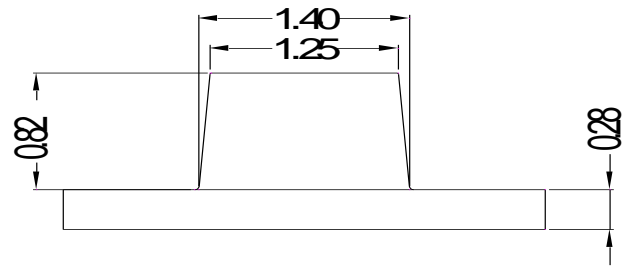

Fig.1-2 Side view

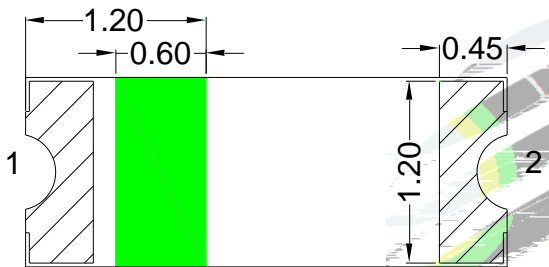

Fig.1-3 Bottom view

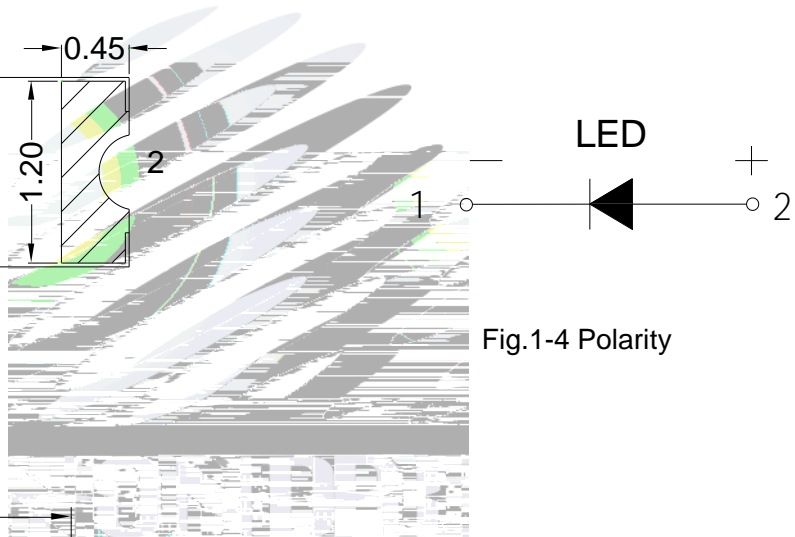

Fig.1-4 Polarity

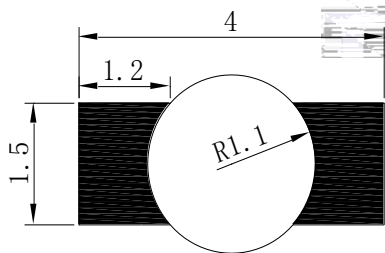

Fig.1-5 Soldering patterns

Notes

1. All dimensions units are millimeters.
2. All dimensions tolerances are $\pm 0.2\text{mm}$ unless otherwise noted.



1.5 Product Parameters

Table 1-1 Electrical / Optical Characteristics at Ts=25°C

| Item | Test Condition | Symbol | Value | | | Unit | |
|-------------------------|----------------------|--------------------|-------------|-------|------|-------|-----|
| | | | Min. () | Typ. | Max. | | |
| Spectral Half Bandwidth | I _F =20mA | Δ | -- | 30 | -- | nm | |
| Forward Voltage | I _F =20mA | V _F | G1 | 2.8 | -- | 2.9 | V |
| | | | G2 | 2.9 | -- | 3.0 | V |
| | | | H1 | 3.0 | -- | 3.1 | V |
| | | | H2 | 3.1 | -- | 3.2 | V |
| | | | I1 | 3.2 | -- | 3.3 | V |
| | | | I2 | 3.3 | -- | 3.4 | V |
| | | | J1 | 3.4 | -- | 3.5 | V |
| Dominant Wavelength | I _F =20mA | D | D20 | 517.5 | -- | 520 | nm |
| | | | E10 | 520 | -- | 522.5 | nm |
| | | | E20 | 522.5 | -- | 525 | nm |
| | | | F10 | 525 | -- | 527.5 | nm |
| | | | F20 | 527.5 | -- | 530 | nm |
| Luminous Intensity | I _F =20mA | I _V | 1AT | 200 | -- | 260 | mcd |
| | | | 1AU | 260 | -- | 330 | mcd |
| | | | 1AV | 330 | -- | 430 | mcd |
| | | | 1CG | 430 | -- | 560 | mcd |
| | | | 1CL | 560 | -- | 700 | mcd |
| | | | 1CM | 700 | -- | 900 | mcd |
| | | | 1CN | 900 | -- | 1200 | mcd |
| Viewing Angle | I _F =20mA | | -- | 140 | -- | deg | |
| Reverse Current | V _R =5V | I _R | -- | -- | 10 | A | |
| Thermal Resistance. | I _F =20mA | R _{THJ-S} | -- | -- | 450 | /W | |

 Notes : V_R=5V For test conditions. V_R=5V

Table 1-2 Absolute Maximum Ratings at Ts=25°C

| Parameter | Symbol | Rating | Units |
|-------------------------------|-----------|-----------|-------|
| Power Dissipation | P_d | 105 | mW |
| Forward Current | I_F | 30 | mA |
| Peak Forward Current Of Pulse | I_{FP} | 60 | mA |
| Electrostatic Discharge (HBM) | E_{SD} | 1000 | V |
| Operating Temperature | T_{opr} | -40 ~ +85 | °C |
| Storage Temperature | T_{stg} | -40 ~ +85 | °C |
| Junction Temperature | T_j | 95 | °C |

Notes

- 1/10 Duty cycle, 0.1ms pulse width. 0.1ms, 1/10.
- The above forward voltage measurement allowance tolerance is $\pm 0.1V$. $\pm 0.1V$.
- The above dominant wavelength measurement allowance tolerance is $\pm 2nm$. $\pm 2nm$.
- The above luminous intensity measurement allowance tolerance $\pm 10\%$. $\pm 10\%$.
- Care is to be taken that power dissipation does not exceed the absolute maximum rating of the product.
- All measurements were made under the standardized environment of Refond.
- When the LEDs are in operation the maximum current should be decided after measuring the package temperature, junction temperature should not exceed the maximum rate.

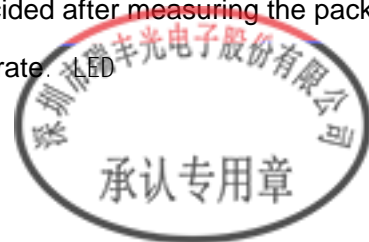

1.6 Typical Optical Characteristics Curves

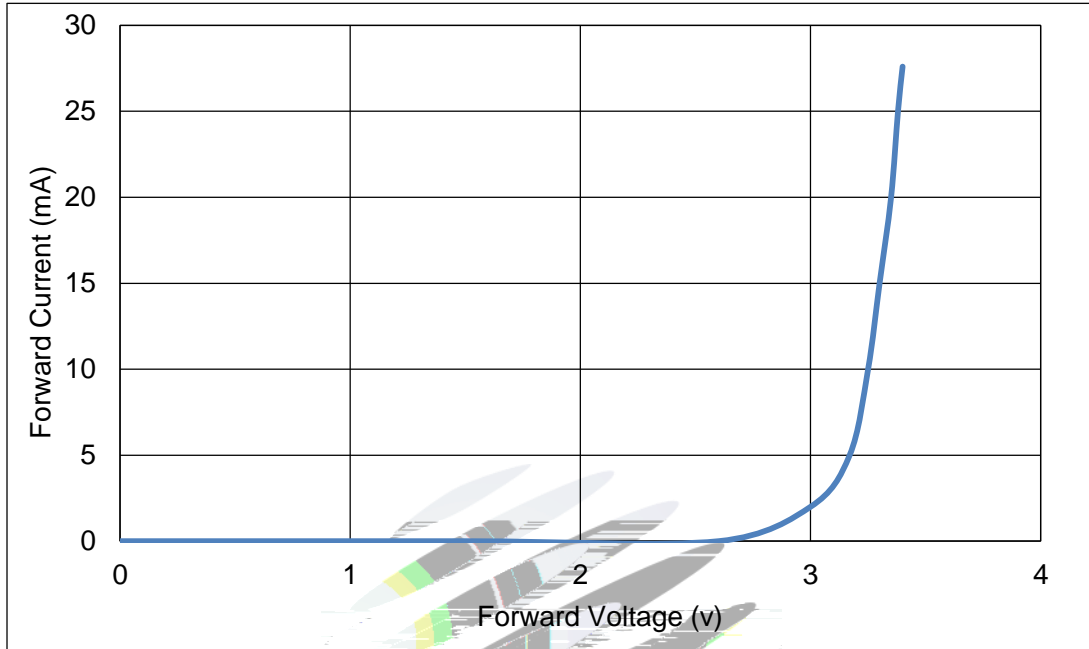

Fig 1-6 Forward Voltage Vs Forward Current

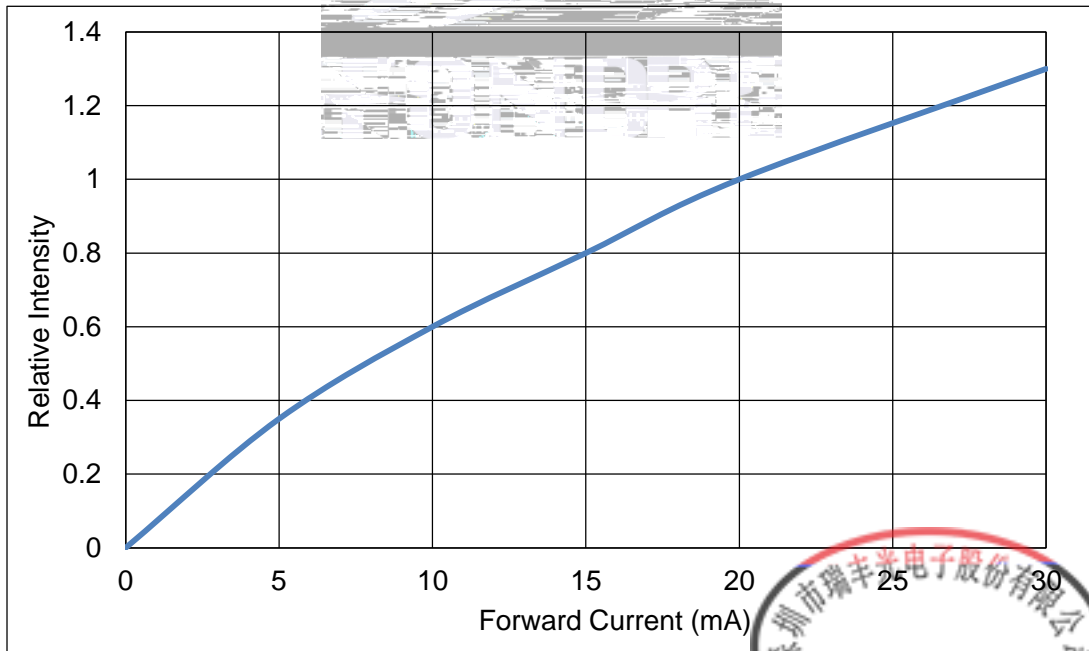
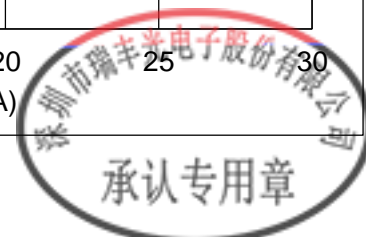
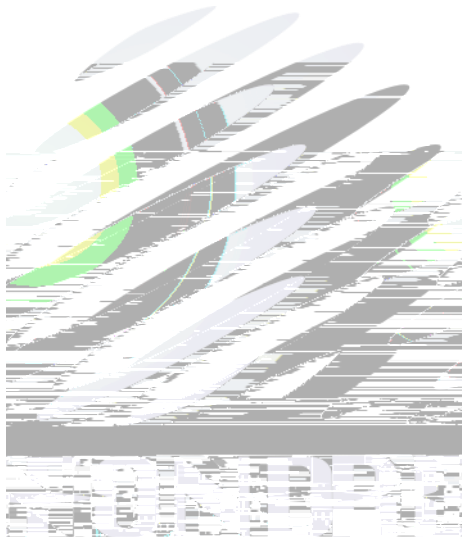
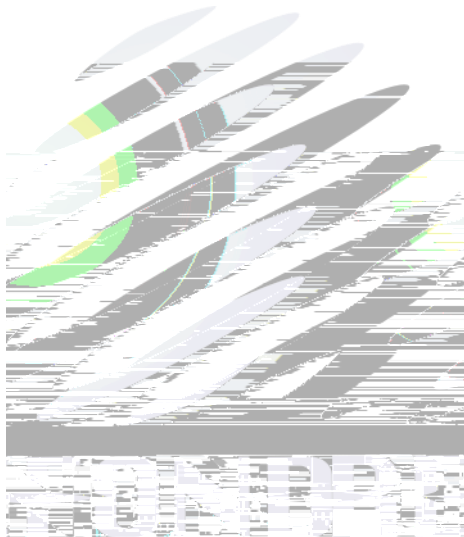
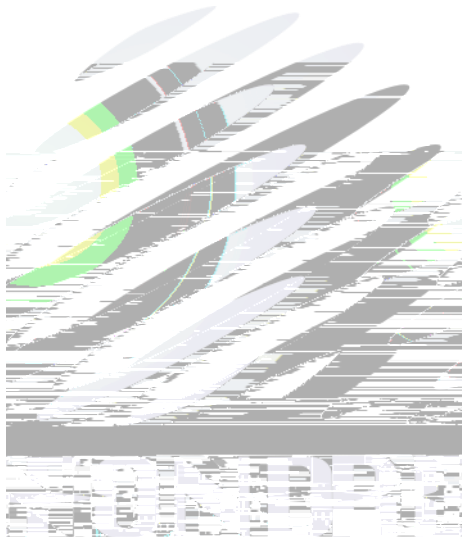

Fig 1-7 Forward Current Vs Relative Intensity









2. Packaging

2.1 Packaging Specification

Package: 3000pcs/reel. 3000pcs

2.1.1 Carrier Tape Dimension

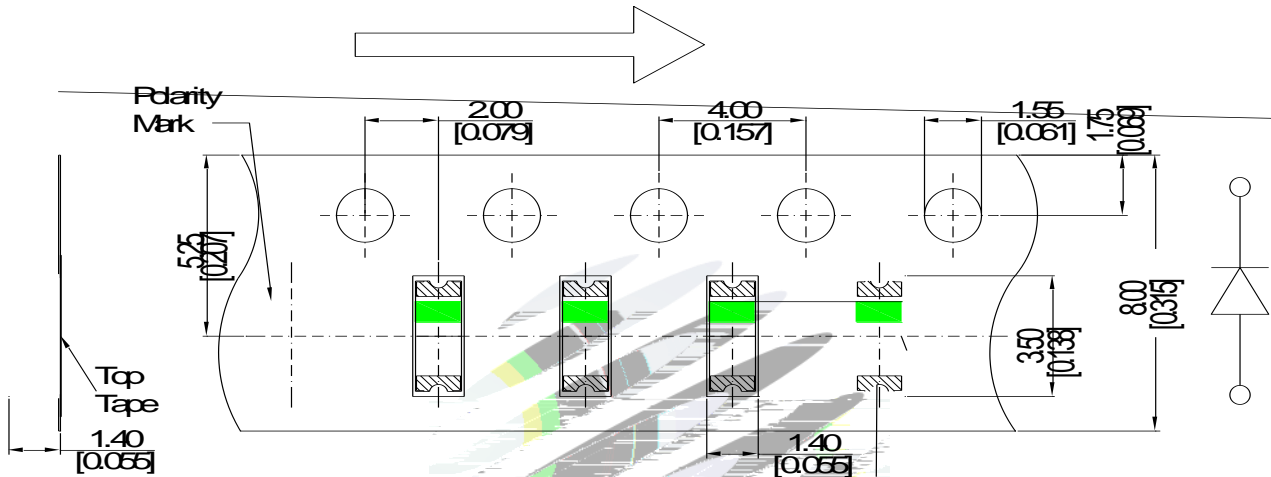

Fig.2-1 Carrier Tape Dimension

2.1.2 Reel Dimension

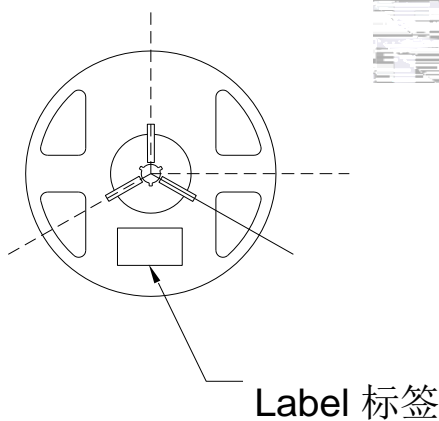

Fig.2-2 Reel Dimension

Table 2-1 Dimension

| | |
|---|-------------|
| A | 8.0± 0.1mm |
| B | 178± 1mm |
| C | 60± 1mm |
| D | 13.0± 0.5mm |

Notes

The tolerances unless mentioned ±0.1mm. Unit : mm



2.1.3 Label Form Specification



| | | |
|---|-------|---|
| PART NO: | |  |
| SPEC NO: | | |
| LOT NO | | |
| BIN CODE: | | |
| Φ: | XY: | |
| VF: | WLD: | |
|  | QTY: | |
| | DATE: | |

Table 2-2 Parameter

| | |
|----------------|------------------|
| PART NO. | Part Number |
| SPEC NO. | Spec Number |
| LOT NO. | Lot Number |
| BIN CODE | Bin Code |
| | Luminous flux |
| XY | Chromaticity Bin |
| V _F | Forward Voltage |
| WLD | Wavelength |
| QTY | Packing Quantity |
| DATE | Made Date |

Fig. 2-3 Label Form Specification

2.2 Moisture Resistant Packing



Fig.2-4 Moisture Resistant Packing

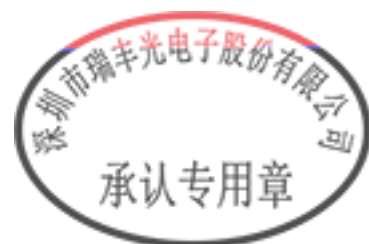

2.3 Cardboard Box

Fig.2-5 Cardboard Box

2.4 Reliability Test Items And Conditions

Table 2-3 Reliability Test Items And Conditions

| Test Items | Ref.Standard | Test Condition | Time | Quantity | Ac/Re / |
|--------------------------|--------------|-----------------------------------|------------|----------|---------|
| Reflow | JESD22-B106 | Temp:260 max T=10 sec | 2 times | 22Pcs. | 0/1 |
| Temperature Cycle | JESD22-A104 | 100 30 min 5 min -40 30 min | 100 cycles | 22Pcs. | 0/1 |
| Thermal Shock | JESD22-A106 | -40 15min 100 15min | 300 cycles | 22Pcs. | 0/1 |
| High Temperature Storage | JESD22-A103 | Temp:100 | 1000 hrs. | 22Pcs. | 0/1 |
| Low Temperature Storage | JESD22-A119 | | | | |

2.5 Criteria For Judging Damage

Table 2-4 Criteria For Judging Damage

| Test Items | Symbol | Test Condition | Criteria For Judgement | |
|-----------------|--------|-------------------|------------------------|-------------|
| | | | Min. | Max. |
| Forward Voltage | V_F | $I_F=20\text{mA}$ | - | U.S.L*)x1.1 |
| Reverse Current | I_R | $V_R= 5\text{V}$ | - | U.S.L*)x2.0 |
| Luminous Flux | | $I_F=20\text{mA}$ | L.S.L*)x0.7 | - |

Not998m[() Ts37uT EMC /ot998m[() Ts37uT EMC /ot998m[() Ts37uT EMC /

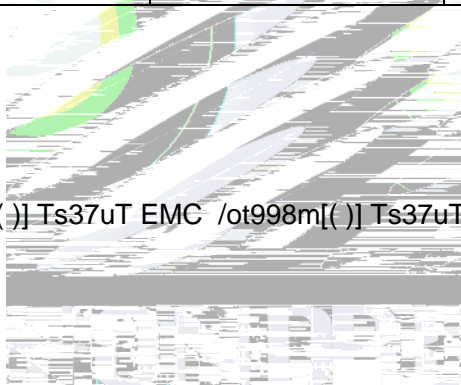

3. SMT Reflow Soldering Instructions

3.1 SMT Reflow Soldering Instructions

Fig.3-1 SMT Reflow Soldering In

Table 3-1 Para

| | | | | |
|---------------------------------|-------|---------|----------|----------|
| Average temperature rise speed | | Tsmax | | |
| Preheating: minimum temperature | | (Tsmir) | | |
| Preheating: Max temperature | | (Tsmax) | | |
| Preheating: Time | Tsmin | Tsmax | 60 - 120 | 60s-120s |
| Time limited to mainta | | | | |

Time limited to mainta

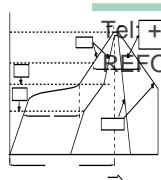

Notes

(1)Reflow soldering should not be done more than twice. If more than 24 hours between the two solderings , LED will be damaged. 24 LED

(2)Whensoldering , do not put stress on the LEDs during heating.

3.1.1 Soldering Iron

(1) When do soldering by hand, keep the temperature of iron below less 300°C less than 3 seconds. 300 3

(2) Soldering by hand should be done only one time.

3.1.2 Repairing

Repairing should not be done after the LEDs have been soldered. When repairing is unavoidable,a double-head soldering iron should be used (as below figure). It should be confirmed in advance whether the characteristics of LEDs will or not be damaged by repairing.

LED

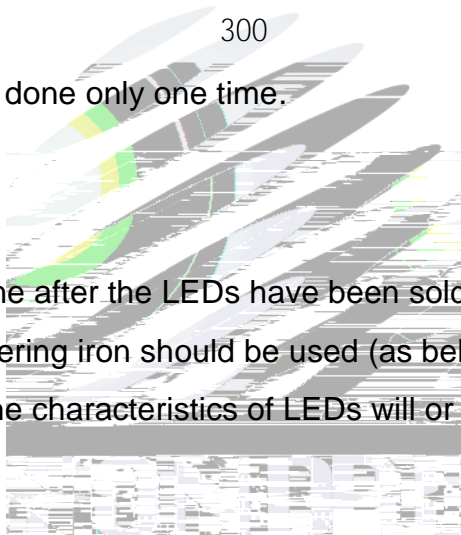

4. Handling Precautions

4.1 Handling Precautions

(1) LED operating environment and sulfur element composition cannot be over 100PPM in the LED mating usage material. This is provided for informational purposes only and is not a warranty or endorsement. LED LED 100PPM.

(2) In order to prevent external material from getting into the inside of LED, which may cause the malfunction of LED, the single content of Bromine element is required to be less than 900PPM, the single content of Chlorine element is required to be less than 900PPM, the total content of Bromine element and Chlorine element in the external materials of the application products is required to be less than 1500PPM. This is provided for informational purposes only and is not a warranty or endorsement.

LED LED
900PPM 900PPM
1500PPM

(3) VOCs (Volatile organic compounds) emitted from materials used in the construction of fixtures can penetrate silicone encapsulants of LEDs and discolor when exposed to heat and photonic energy. The result can be a significant loss of light output from the fixture. Knowledge of the properties of the materials selected to be used in the construction of fixtures can help prevent these issues. Refond advises against the use of any chemicals or materials that have been found or are suspected to have an adverse effect on device performance or reliability. To verify compatibility, Refond recommends that all chemicals and materials be tested in the specific application and environment for which they are intended to be used. Attaching LEDs, do not use adhesives that outgas organic vapor. LED

LED

LED

LED

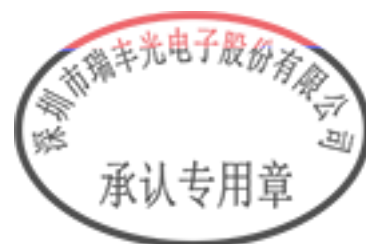

(4) Handle the component along the side surface by using forceps or appropriate tools; Do not directly touch or Handle the silicone lens surface, it may damage the internal circuitry.

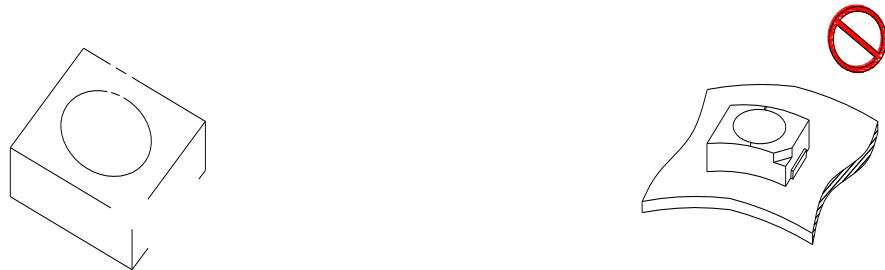
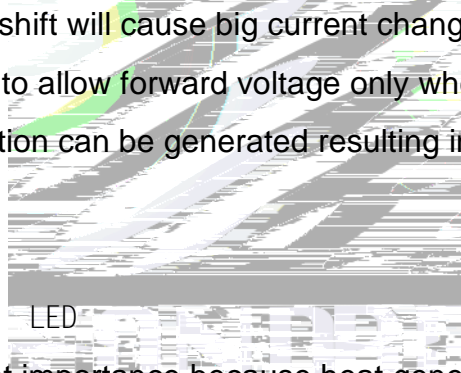

Fig 4-1 Handling Precautions 产品使用注意事项

(5) In designing a circuit, the current through each LED can not exceed the absolute maximum rating specified for each LED. In the mean while, resistors for protection should be applied, otherwise slight voltage shift will cause big current change, burn out may happen. The driving circuit must be designed to allow forward voltage only when it is ON or OFF. If the reverse voltage is applied to LED, migration can be generated resulting in LED damage.

LED



(6) Thermal Design is paramount importance because heat generation may result in the Characteristics decline, such as brightness decreased, Color change and so on. Please consider the heat generation of the LEDs when making the system design. LED

LED

(7) Compared to standard encapsulants, silicone is generally softer, and the surface is more likely to attract dust, requiring special care during processing. In cases where a minimal level of dirt and dust particles cannot be guaranteed, a suitable cleaning solution must be applied to the surface after the soldering of components. Refond suggests using isopropyl alcohol for cleaning. In case other solvents are used, it must be assured that these solvents do not dissolve the package or resin. Ultrasonic cleaning is not recommended. Ultrasonic cleaning may cause damage to the

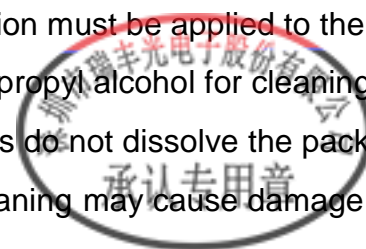

LED.

LED

Table 4-1 Storage

| Conditions | | Temperature | Humidity | Time |
|------------|-----------------------------|-------------|----------|-------------------------|
| Storage | Before Opening Aluminum Bag | 30 | 75% | Within 1 Year From Date |
| | After Opening Aluminum Bag | 30 | 60% | 168hours 168 |
| Baking | | 60± 5 | - | 24hours 24 |

(8) If the moisture absorbent material silica gel has faded away or the LEDs have exceeded the storage time, baking treatment should be performed after unpacking and based on the following condition 60±5 °C for above 24 hours.

60± 5 24

If the package is flatulence or damaged, please notify the sales staff to assist.

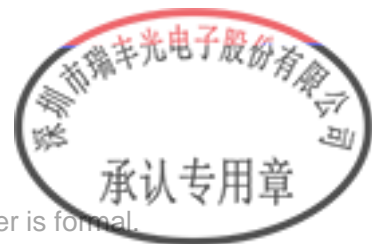

Declare

This specification is written both in English and in Chinese and the latter is formal.