

# SPECIFICATION

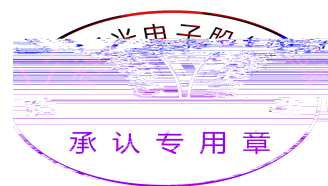

## Contents

- 1. Description
  - 1.1 General Description
  - 1.2 Features
  - 1.3 Application
  - 1.4 Package Dimension
  - 1.5 Product Parameters

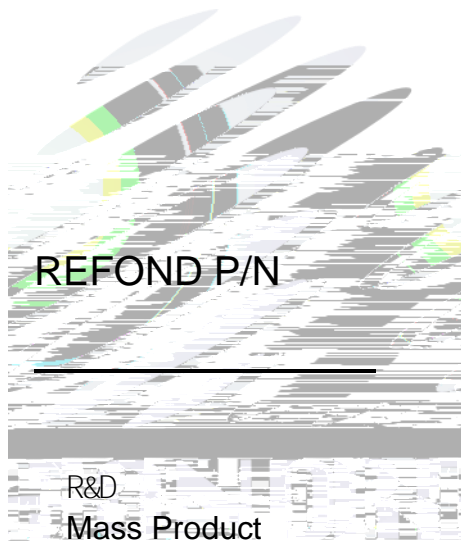
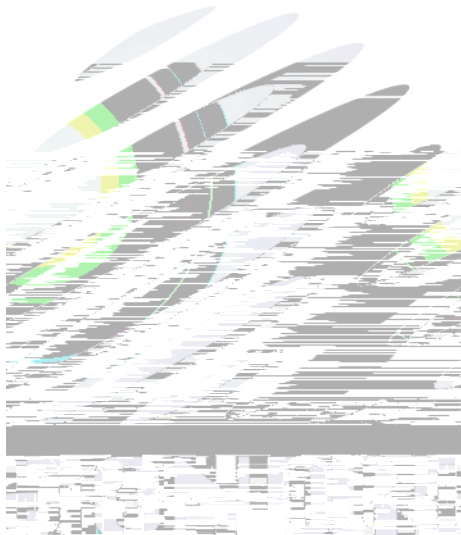

# 1. Description

## 1.1 General Description

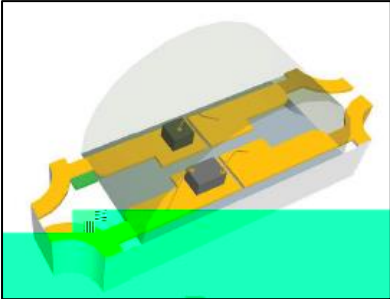

The Colour LED which was fabricated using a yellow chip and green chip, Package Dimension : 3.2mmX1.0mmX1.48mm.

LED

3.2mmX1.0mmX1.48mm

## 1.2 Features

Extremely wide viewing angle.

Suitable for all SMT assembly and solder process.

Moisture sensitivity level: Level 3.

RoHS compliant. RoHS

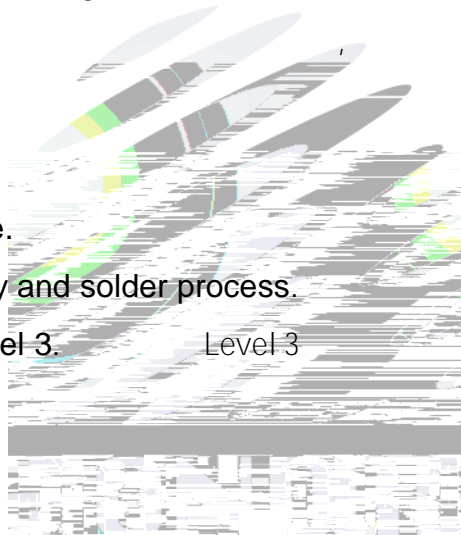

SMT

## 1.3 Application

Optical indicator.

Switch and symbol, display.

General use.

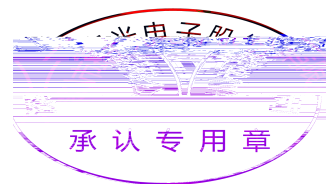

## 1.4 Package Dimension

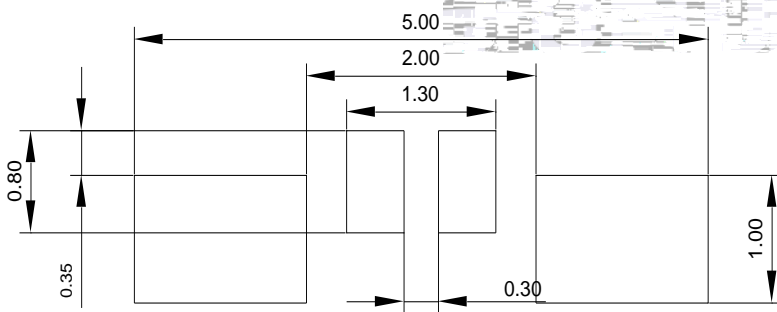
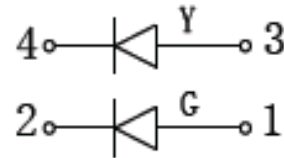
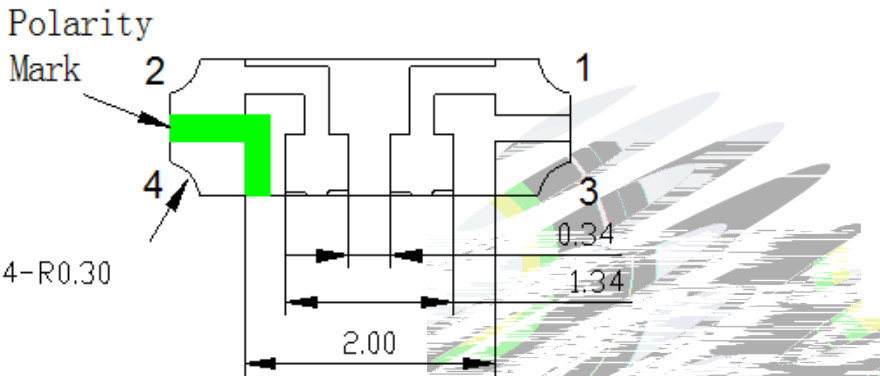
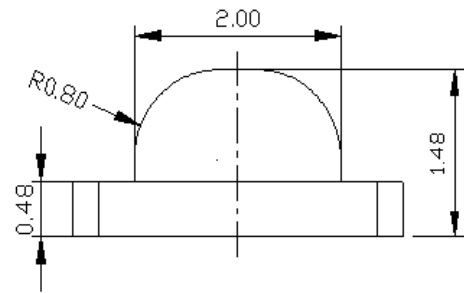
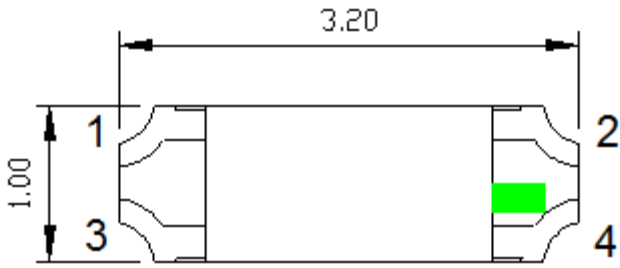

### Notes

1. All dimensions units are millimeters.

All dimensions tolerances are  $\pm 0.2\text{mm}$  unless otherwise noted.

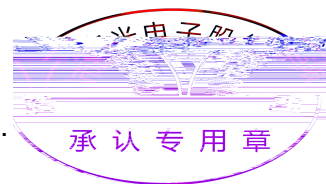

$\pm 0.2$

## 1.5 Product Parameters

Table 1-1 Electrical / Optical Characteristics at Ts=25°C

Item	Test Condition	Symbol	Code	Value			Unit
				Min. ( )	Typ.	Max.	
Spectral Half Bandwidth	I <sub>F</sub> =20mA	Y	/	--	15	--	nm

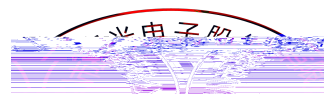
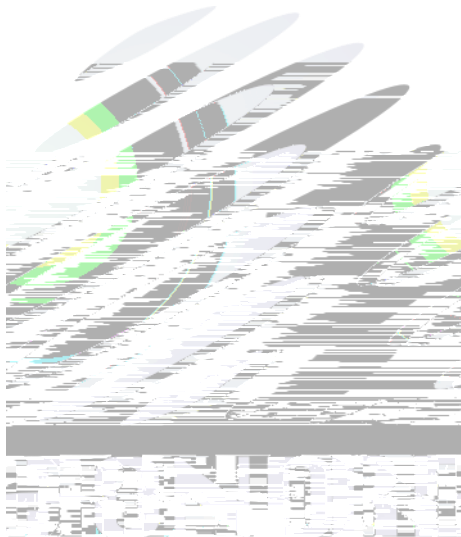

Notes : V<sub>R</sub>=5V For test conditions. V<sub>R</sub>=5V

Table 1-2 Absolute Maximum Ratings at Ts=25°C

Parameter	Symbol	Rating		Units
		Y	G	
Power Dissipation	$P_d$	48	68	mW
Forward Current	$I_F$	20		mA
Peak Forward Current Of Pulse	$I_{FP}$	60		mA
Electrostatic Discharge (HBM)	$E_{SD}$	1000		V
Operating Temperature	$T_{opr}$	-40 ~ +85		°C
Storage Temperature	$T_{stg}$	-40 ~ +85		°C
Junction Temperature	$T_j$	95		°C

## Notes

- 1/10 Duty cycle, 0.1ms pulse width. 0.1ms, 1/10.
- The above forward voltage measurement allowance tolerance is  $\pm 0.1V$ .  $\pm 0.1V$ .
- The above dominant wavelength measurement allowance tolerance is  $\pm 2nm$ .  $\pm 2nm$ .
- The above luminous intensity measurement allowance tolerance  $\pm 10\%$ .  $\pm 10\%$ .
- Care is to be taken that power dissipation does not exceed the absolute maximum rating of the product.
- All measurements were made under the standardized environment of Refond.
- When the LEDs are in operation the maximum current should be decided after measuring the package temperature, junction temperature should not exceed the maximum rate. LED



## 1.6 Typical Optical Characteristics Curves

Fig.1-6 Forward Voltage Vs Forward Current

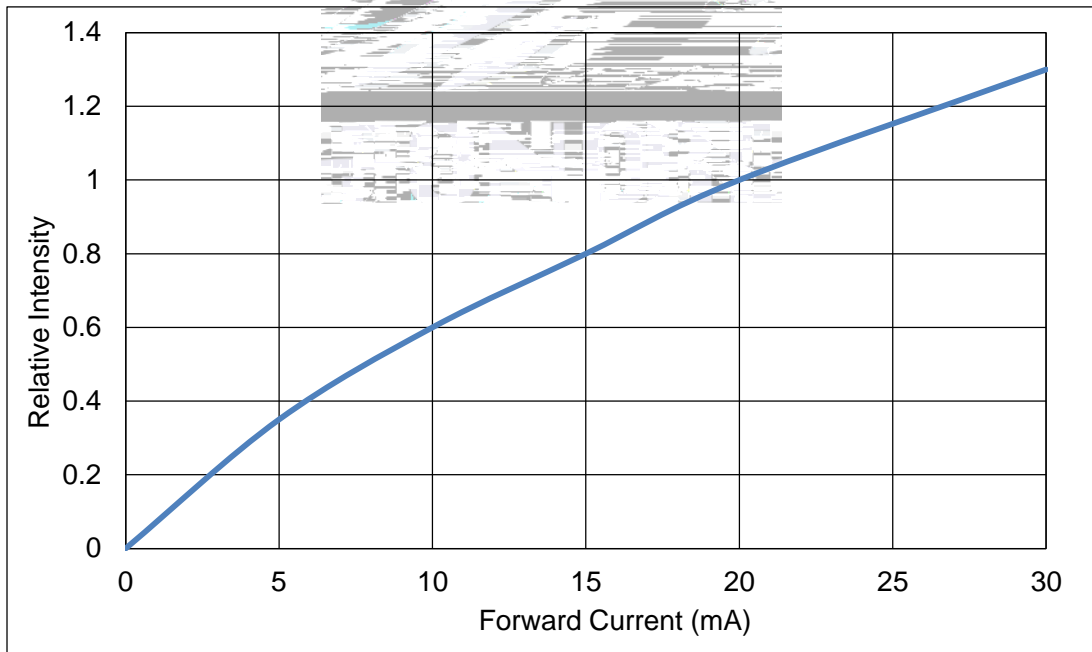

Fig.1-7 Forward Current Vs Relative Intensity

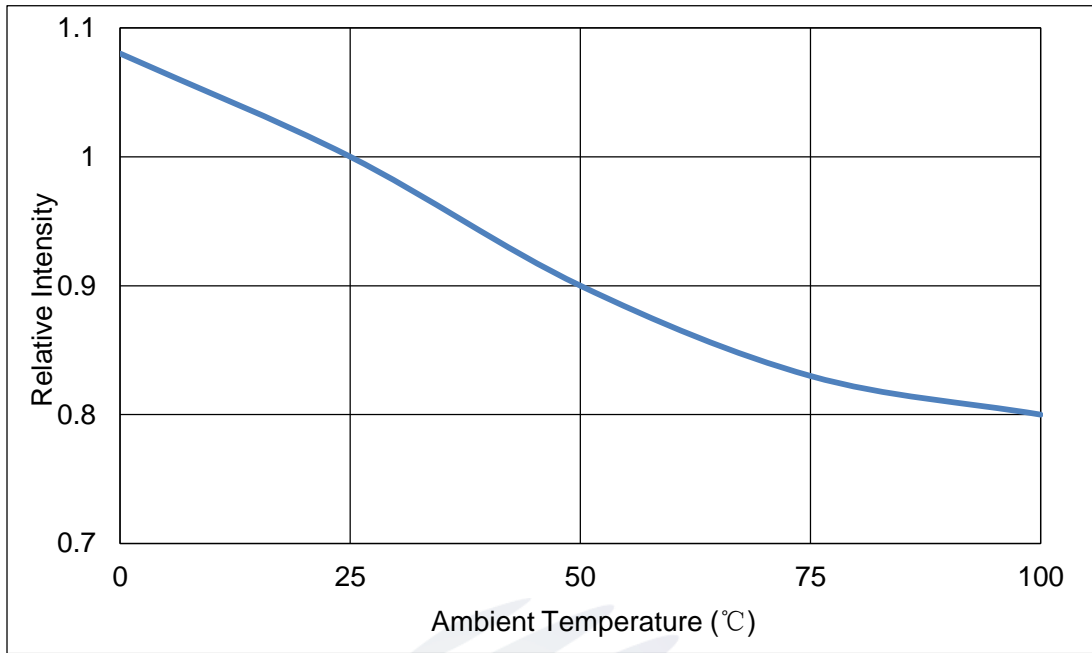

Fig.1-8 Pin Temperature Vs Relative Intensity

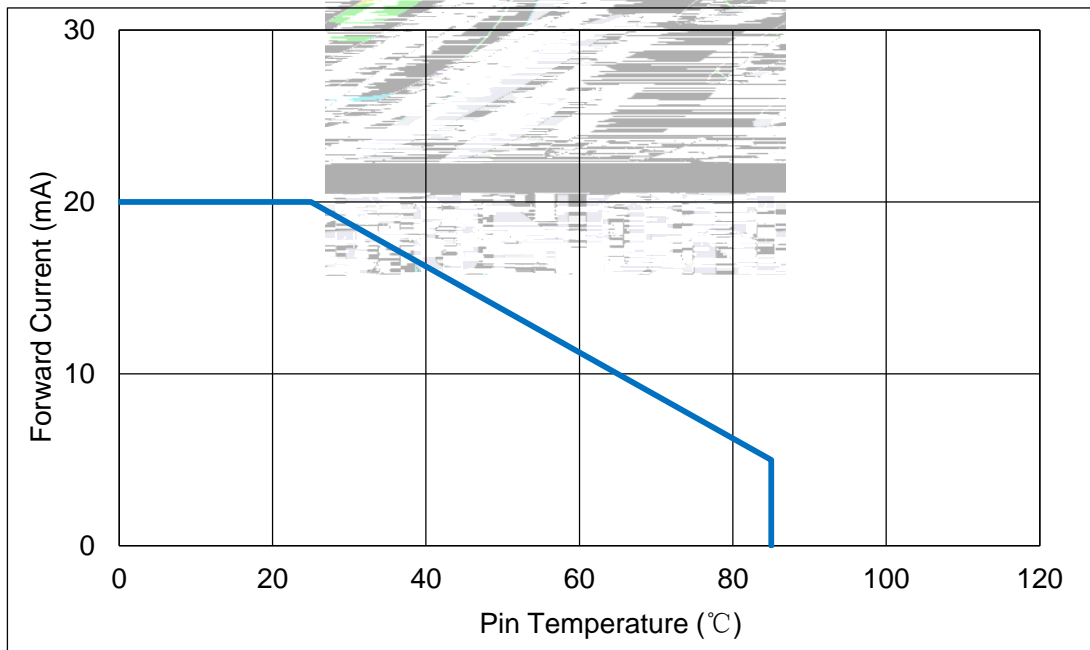
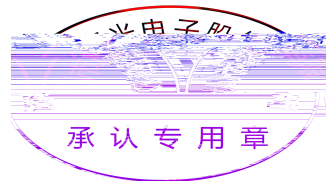

Fig.1-9 Pin Temperature Vs Forward Current





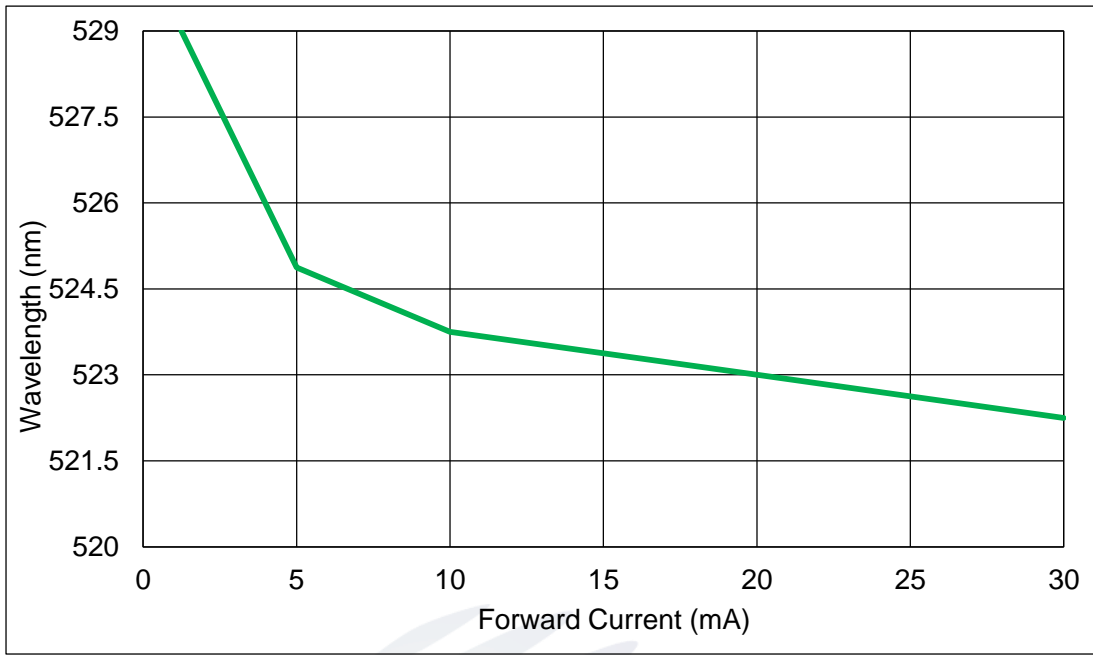

Fig.1-10 Forward Current Vs Dominate Wavelength (Ta=25 )

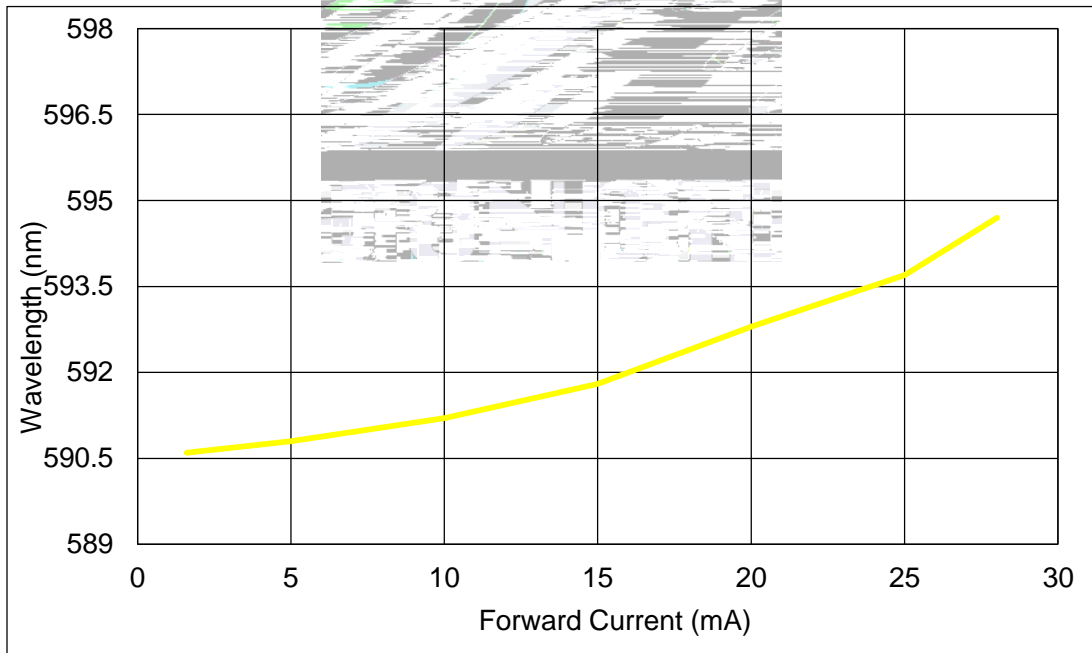
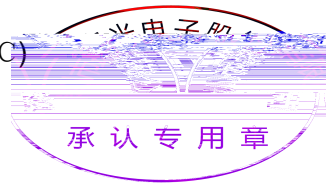

Fig.1-11 Forward Current Vs Dominate Wavelength (Ta=25°C)



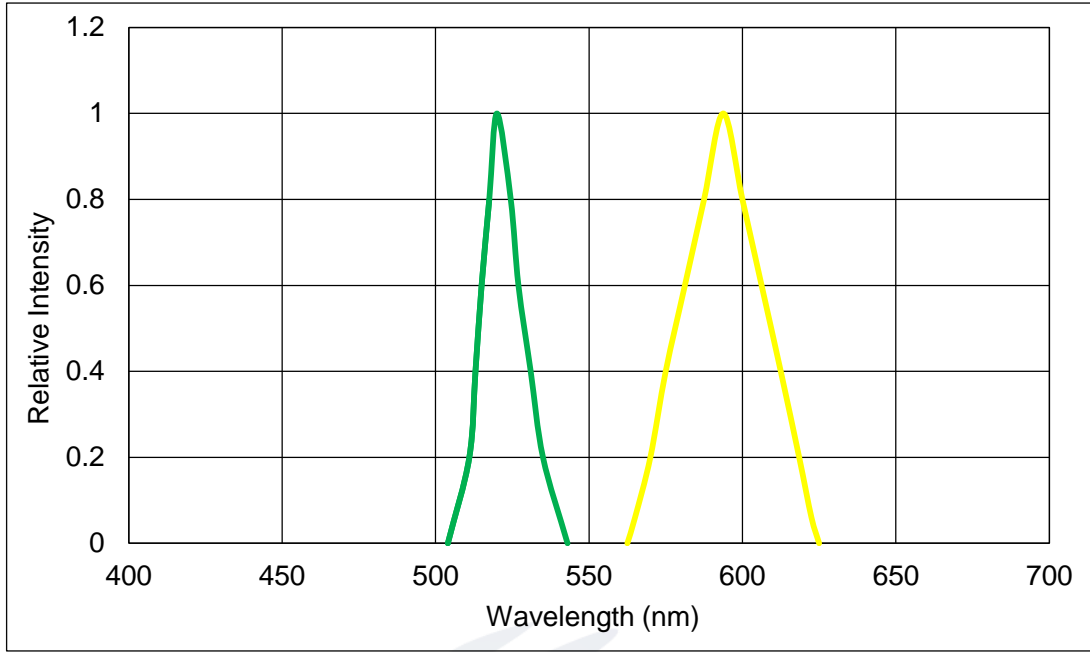

Fig.1-12 Relative Intensity Vs Wavelength (Ta=25°C)

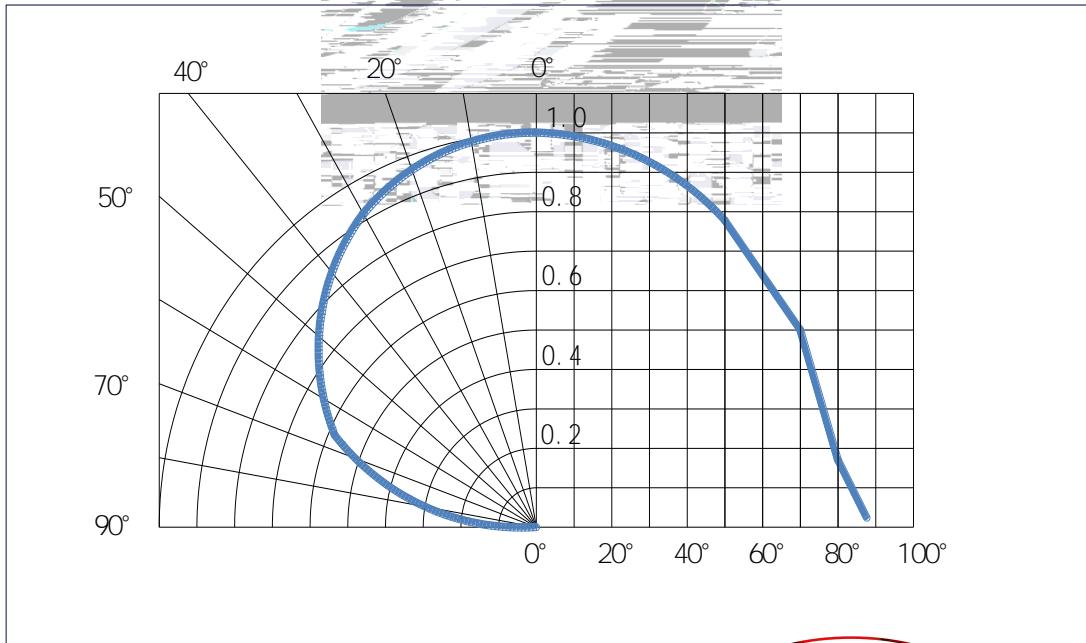
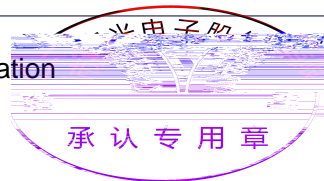

Fig.1-13 Diagram characteristics of radiation



## 2. Packaging

### 2.1 Packaging Specification

Package:3000pcs/reel.

3000pcs

#### 2.1.1 Carrier Tape Dimension

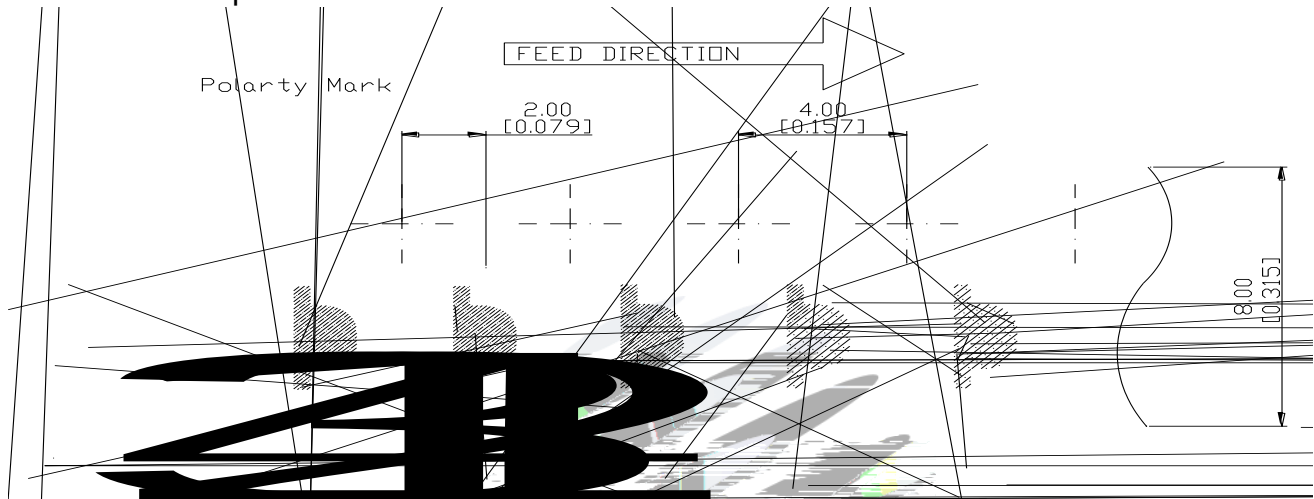

Fig.2-1 Carrier Tape Dimension

#### 2.1.2 Reel Dimension

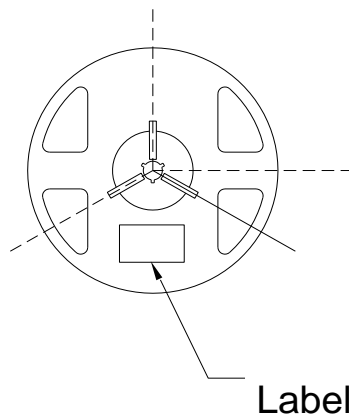

Fig.2-2 Reel Dimension

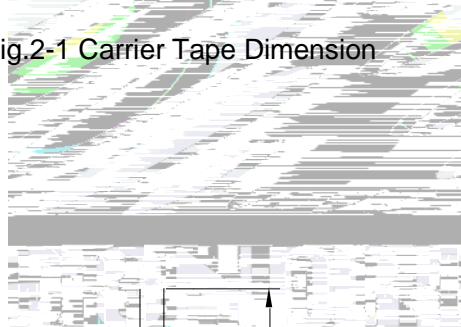
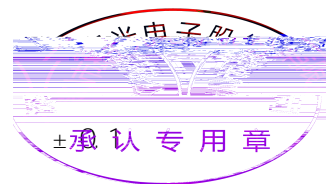

Table 2-1 Dimension

A	8.0± 0.1mm
B	178± 1mm
C	60± 1mm
D	13.0± 0.5mm

#### Notes

The tolerances unless mentioned ±0.1mm. Unit : mm



### 2.1.3 Label Form Specification

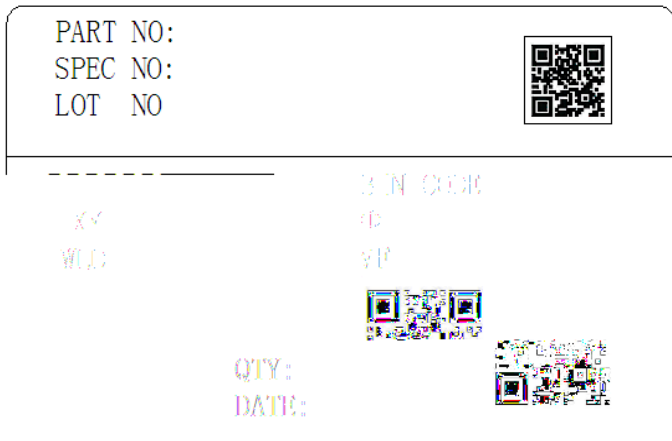

Table 2-2 Parameter

PART NO.	Part Number
SPEC NO.	Spec Number
LOT NO.	Lot Number
BIN CODE	Bin Code
	Luminous flux
XY	Chromaticity Bin
V <sub>F</sub>	Forward Voltage
WLD	Wavelength
QTY	Packing Quantity
DATE	Made Date

Fig. 2-3 Label Form Specification

### 2.2 Moisture Resistant Packing

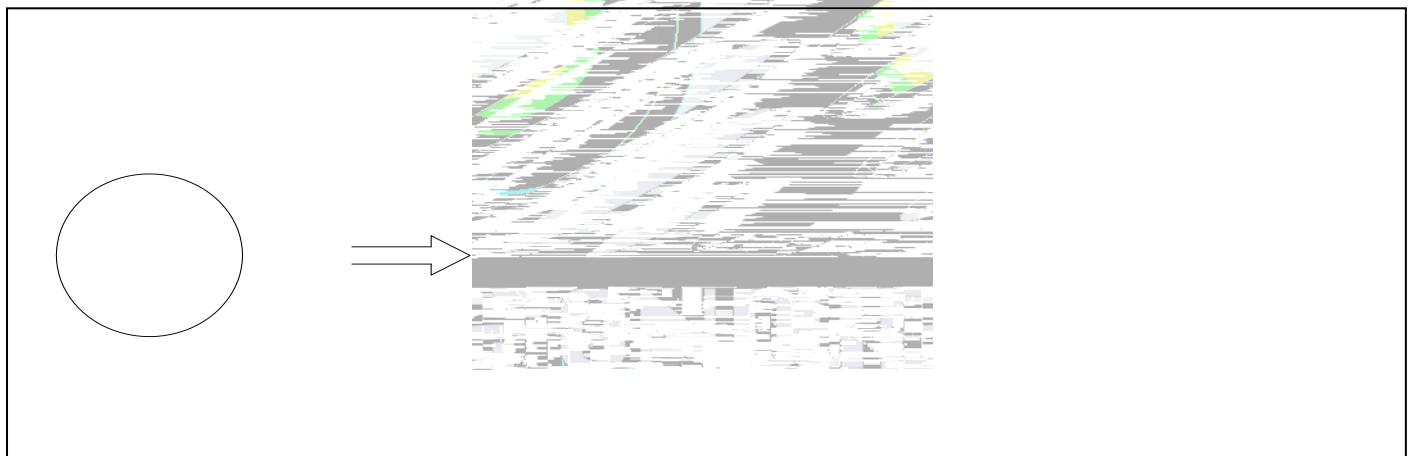
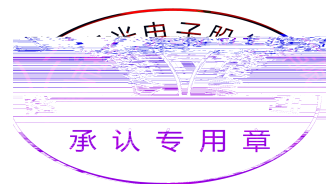
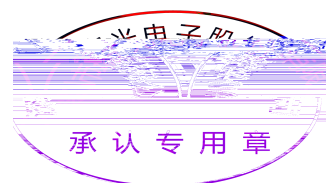

Fig.2-4 Moisture Resistant Packing



## 2.3 Cardboard Box



## 2.5 Criteria For Judging Damage

Table 2-4 Criteria For Judging Damage

Test Items	Symbol	Test Condition	Criteria For Judgement	
			Min.	Max.
Forward Voltage	$V_F$	$I_F=20mA$	-	U.S.L*)x1.1
Reverse Current	$I_R$	$V_R= 5V$	-	U.S.L*)x2.0
Luminous Flux		$I_F=20mA$	L.S.L*)x0.7	-

### Notes

1.U.S.L: Upper standard level

L.S.L: Lower standard level

2.The above reliability tests is based on the verification of a single/strip LED of Refond's existing experimental platform,the reliability experiment was taken under good heat dissipation conditions. When customers applies the LED to the series and parallel circuit,should take consideration of all the factors such as the current, voltage distribution, heat dissipation and others.

LED

3.The technical information shown in the data sheets is limited to the typical characteristics and circuit examples of the referenced products. It does not constitute the warranting of industrial property nor the granting of any license.

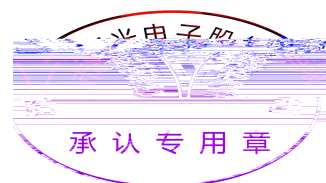

### 3. SMT Reflow Soldering Instructions SMT

#### 3.1 SMT Reflow Soldering Instructions SMT

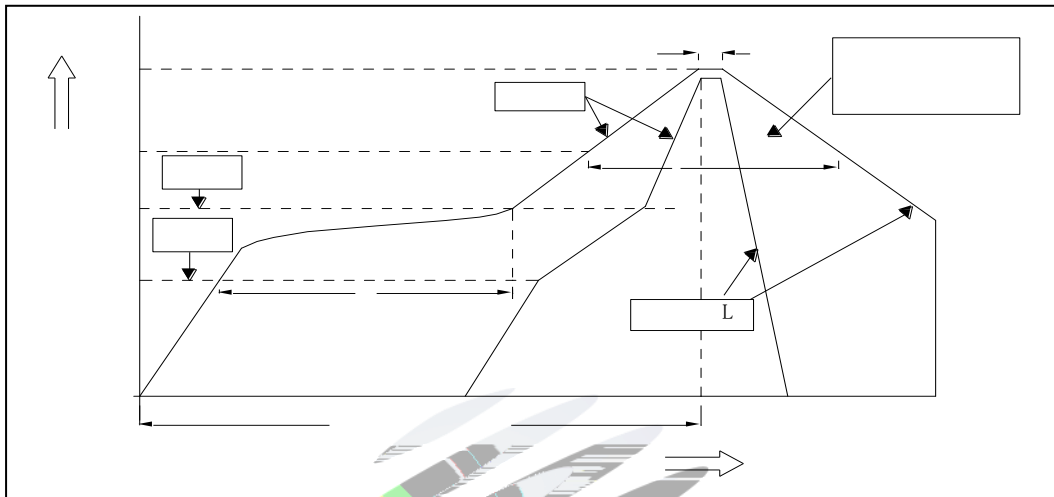

Fig.3-1 SMT Reflow Soldering Instructions SMT

Table 3-1 Parameters

Average temperature rise speed	$T_{smax}$	$T_P$	3 °C/	Max 3 °C/ s
Preheating: minimum temperature	(T <sub>min</sub> )		150 °C	
Preheating: Max temperature	(T <sub>smax</sub> )		200 °C	
Preheating: Time	T <sub>min</sub>	T <sub>smax</sub>	60 - 120	60s-120s
Time limited to maintain high temperature: the temperature (T <sub>L</sub> )	217 °C			
Time limited to maintain high temperature: The Time (t <sub>L</sub> )			60-150	Max 60s-150S
Peak /Classification of temperature:	/	(T <sub>P</sub> )	260 °C	
Time limit classification of peak temperature time t <sub>p</sub>			10	Max 10s
(T <sub>P</sub> )	5 °C	Hold time within 5 °	30	Max 30s
C with the actual peak temperature (T <sub>P</sub> )				
Cooling speed			6 °C/	Max 6 °C/ s
25 °C	Needed time from 25 °C to T <sub>p</sub>		8	Max 8 minutes

Notes

(1)Reflow soldering should not be done more than twice. If more than 24 hours between the two solderings, LED will be damaged. 24 LED

(2)Whensoldering , do not put stress on the LEDs during heating.

3.1.1 Soldering Iron

(1) When do soldering by hand, keep the temperature of iron below less 300°C less than 3 seconds. 300 3

(2) Soldering by hand should be done only one time.

3.1.2 Repairing

Repairing should not be done after the LEDs have been soldered. When repairing is unavoidable,a double-head soldering iron should be used (as below figure). It should be confirmed in advance whether the characteristics of LEDs will or not be damaged by repairing.

LED

LED

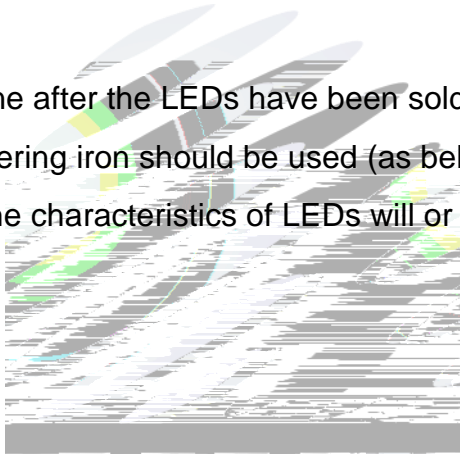

3.1.3 Cautions

(1) The encapsulated material of the LEDs is silicone. Therefore the LEDs have a soft surface on the top of package. The pressure to the top surface will be impacted on the reliability of the LEDs. Precautions should be taken to avoid the strong pressure on the encapsulated part. So when use the picking up nozzle, the pressure on the silicone resin should be proper. LED



## 4. Handling Precautions

### 4.1 Handling Precautions

(1) LED operating environment and sulfur element composition cannot be over 100PPM in the LED mating usage material. This is provided for informational purposes only and is not a warranty or endorsement. LED LED 100PPM.

(2) In order to prevent external material from getting into the inside of LED, which may cause the malfunction of LED, the single content of Bromine element is required to be less than 900PPM, the single content of Chlorine element is required to be less than 900PPM, the total content of Bromine element and Chlorine element in the external materials of the application products is required to be less than 1500PPM. This is provided for informational purposes only and is not a warranty or endorsement.

1500PPM.

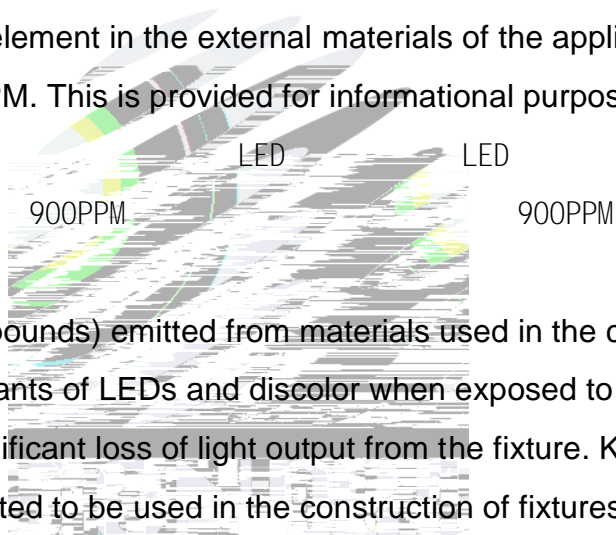

(3) VOCs (Volatile organic compounds) emitted from materials used in the construction of fixtures can penetrate silicone encapsulants of LEDs and discolor when exposed to heat and photonic energy. The result can be a significant loss of light output from the fixture. Knowledge of the properties of the materials selected to be used in the construction of fixtures can help prevent these issues. Refond advises against the use of any chemicals or materials that have been found or are suspected to have an adverse effect on device performance or reliability. To verify compatibility, Refond recommends that all chemicals and materials be tested in the specific application and environment for which they are intended to be used. Attaching LEDs, do not use adhesives that outgas organic vapor. LED

LED

LED

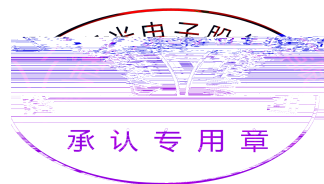

(4) Handle the component along the side surface by using forceps or appropriate tools; Do not directly touch or Handle the silicone lens surface, it may damage the internal circuitry.

Fig 4-1 产品使用注意事项

(5) In designing a circuit, the current through each LED can not exceed the absolute maximum rating specified for each LED. In the meanwhile, resistors for protection should be applied, otherwise slight voltage shift will cause big current change, burn out may happen. The driving circuit must be designed to allow forward voltage only when it is ON or OFF. If the reverse voltage is applied to LED, migration can be generated resulting in LED damage.

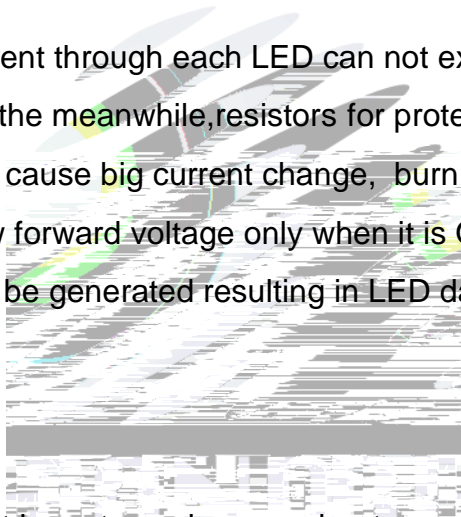

LED

LED

(6) Thermal Design is paramount importance because heat generation may result in the Characteristics decline, such as brightness decreased, Color change and so on. Please consider the heat generation of the LEDs when making the system design.

LED

LED.

LED

Table 4-1 Storage

Conditions

Temperature

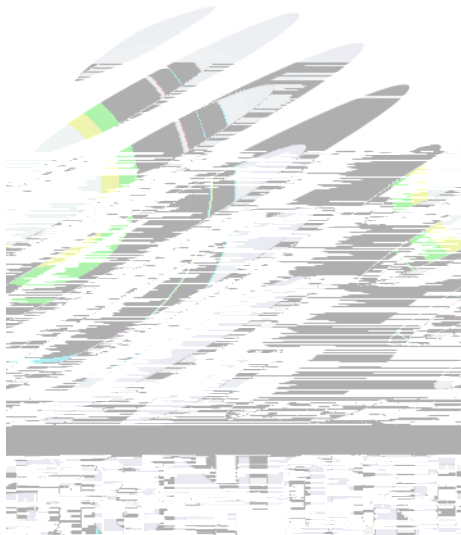





Declare

This specification is written both in English and in Chinese and the latter is formal.

