

Contents

- 1. Description
- 1.1 General Description
- 1.2 Features
- 1.3 Application
- 1.4 Package Dimension
- 1.5 Product Parameters
- 1.6 Bin Range Of Forward Voltage and Luminous Flux (IF=150mA) BIN
- (IF=150mA)
- 1.7 Typical Optical Characteristics Curves

The logo for REFOND, featuring the word "REFOND" in a stylized, blocky font with a blue-to-purple gradient. Above the text is a graphic of several overlapping, curved, brushstroke-like lines in the same color gradient.

1. Description

1.1 General Description



The Yellow LED, which was fabricated by using a blue chip and the phosphor.

Product Package: 3.2mmX3.0mmX0.6mm.

LED

3.2mmX3.0mmX0.6mm

1.2 Features

EMC Package. EMC

Extremely wide viewing angle.

Suitable for all SMT assembly and solder process. SMT

Available on tape and reel.

Moisture sensitivity level: Level 2. Level2

Compliance with RoHS and REACH. RoHS REACH

Qualifications: The product qualification test plan is based on the guidelines of AEC-Q101
Stress Test Qualification for Automotive Grade Discrete Semiconductors

AEC-Q101

1.3 Application

Automotive Lighting Interior and Exterior.



1.4 Package Dimension

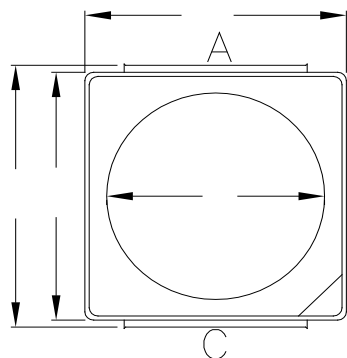

Fig.1-1 Top View

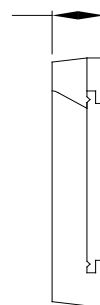

Fig.1-2 Side View

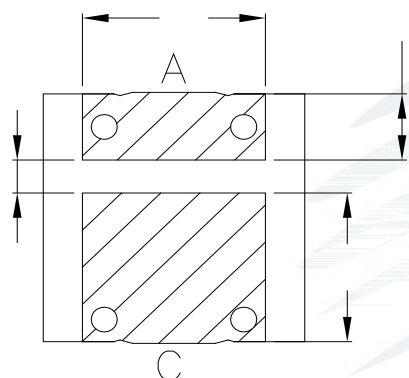

Fig.1-3 Bottom View

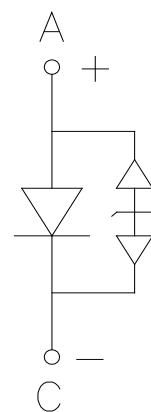

Fig.1-4 Polarity

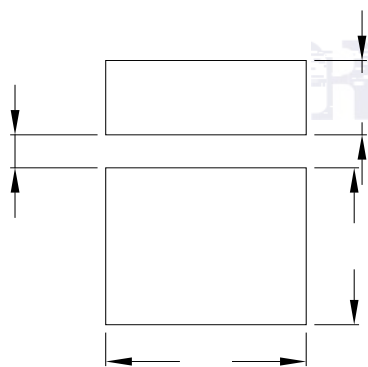

Fig.1-5 Soldering Patterns

Notes

1. All dimensions units are millimeters.
2. All dimensions tolerances are $\pm 0.2\text{mm}$ unless otherwise noted.



1.5 Product Parameters

Table 1-1 Electrical / Optical Characteristics at Ts=25°C

| Item | Symbol | Test Condition | Value | | | Unit |
|---------------------|-------------|--------------------|-------|------|------|---------------|
| | | | Min. | Typ. | Max. | |
| Forward Voltage | V_F | $I_F=150\text{mA}$ | 2.8 | --- | 3.4 | V |
| Reverse Current | I_R | $V_R=5\text{V}$ | --- | --- | 10 | μA |
| Luminous Flux | | $I_F=150\text{mA}$ | 40.9 | 49 | 61.2 | lm |
| Viewing Angle | | $I_F=150\text{mA}$ | --- | 120 | --- | deg |
| Thermal Resistance. | R_{THJ-S} | $I_F=150\text{mA}$ | --- | --- | 21 | /W |

Table 1-2 Absolute Maximum Ratings at Ts=25°C

| Parameter | Symbol | Rating | Units |
|-------------------------------|-----------|------------|-------|
| Power Dissipation | P_D | 680 | mW |
| Forward Current | I_F | 180 | mA |
| Peak Forward Current | I_{FP} | 300 | mA |
| Reverse Voltage | V_R | 5 | V |
| Electrostatic Discharge (HBM) | E_{SD} | 8000 | V |
| Operating Temperature | T_{OPR} | -40 ~ +110 | |
| Storage Temperature | T_{STG} | -40 ~ +110 | |
| Junction Temperature | T_J | 125 | |

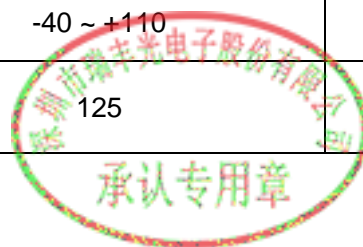

Notes

1. 1/10 Duty cycle, 10ms pulse width. 10ms, 1/10.
2. The above forward voltage measurement allowance tolerance is $\pm 0.1V$. $\pm 0.1V$.
3. The above color coordinates measurement allowance tolerance is ± 0.005 . ± 0.005 .
4. The above luminous intensity measurement allowance tolerance $\pm 10\%$. $\pm 10\%$.
5. Care is to be taken that power dissipation does not exceed the absolute maximum rating of the product.
6. All measurements were made under the standardized environment of Refond.
7. When the LEDs are in operation the maximum current should be decided after measuring the package temperature, junction temperature should not exceed the maximum rate. LED
8. ESD yield is over 90% at 8000V ESD (HBM). ESD protection during products handling is needed. 90% LED ESD8000V

1.6 Bin Range Of Forward Voltage and Luminous Flux (IF=150mA)

BIN (IF=150mA)

Table 1-3

| | | | | | | |
|----------------|-----------|---------|---------|-----------|---------|---------|
| V _F | G1 | G2 | H1 | H2 | I1 | I2 |
| | 2.8-2.9 | 2.9-3.0 | 3.0-3.1 | 3.1-3.2 | 3.2-3.3 | 3.3-3.4 |
| Im | NB | OA | OB | PA | | |
| | 40.9-45.3 | 45.3-50 | 50-55.3 | 55.3-61.2 | | |



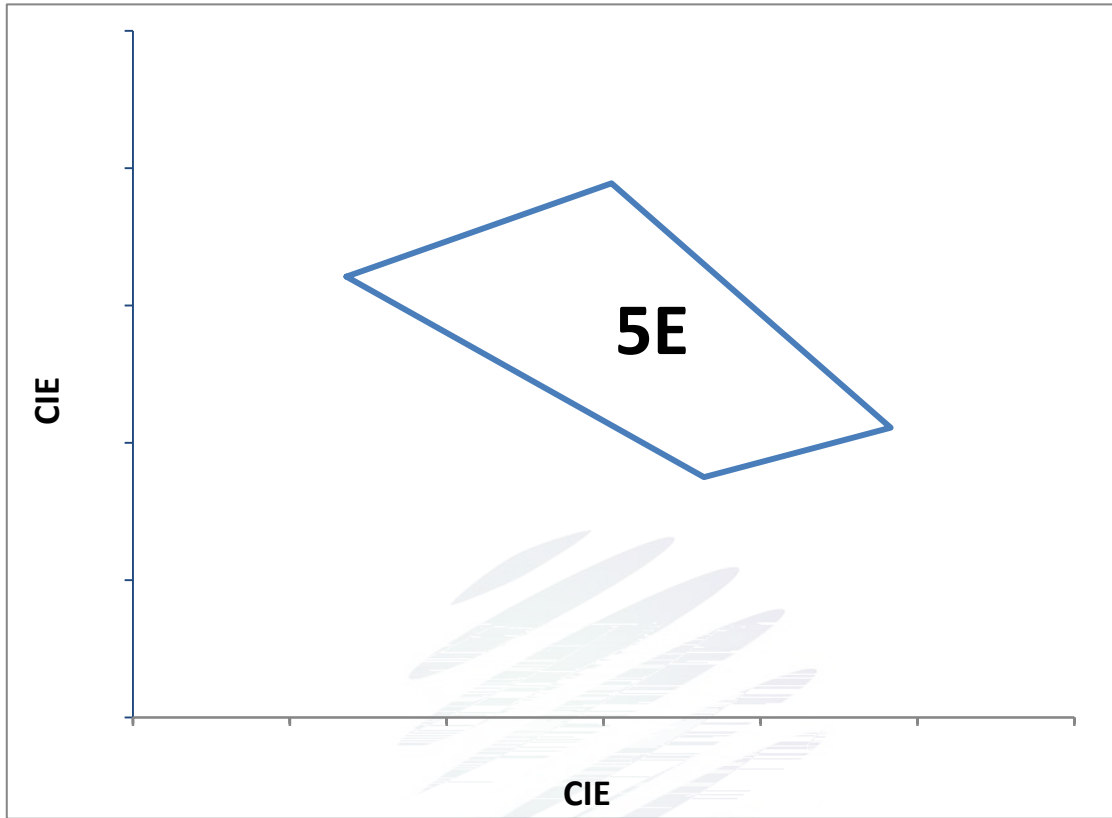

Fig. 1-6 The C.I.E Chromaticity Diagram CIE

Table 1-4

| BIN CODE | CIE-X1 | CIE-Y1 | CIE-X2 | CIE-Y2 | CIE-X3 | CIE-Y3 | CIE-X4 | CIE-Y4 |
|----------|--------|--------|--------|--------|--------|--------|--------|--------|
| 5E | 0.5536 | 0.4221 | 0.5764 | 0.4075 | 0.5883 | 0.4111 | 0.5705 | 0.4289 |



1.7 Typical Optical Characteristics Curves

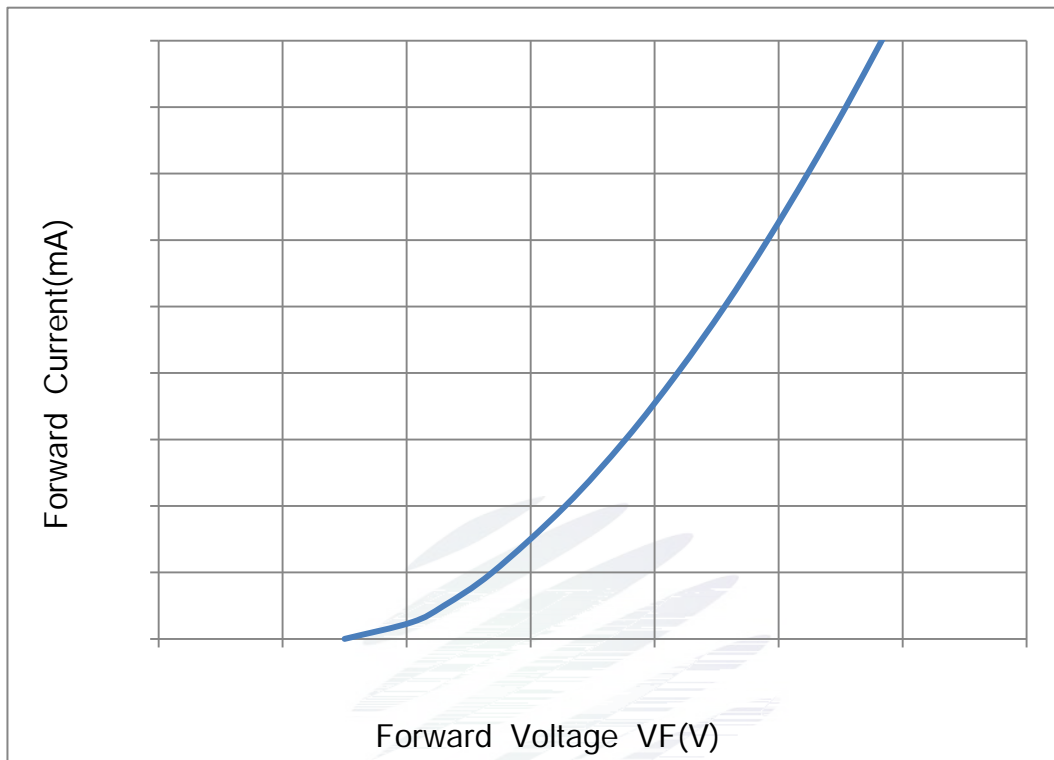

Fig. 1-7 Forward Voltage Vs Forward Current

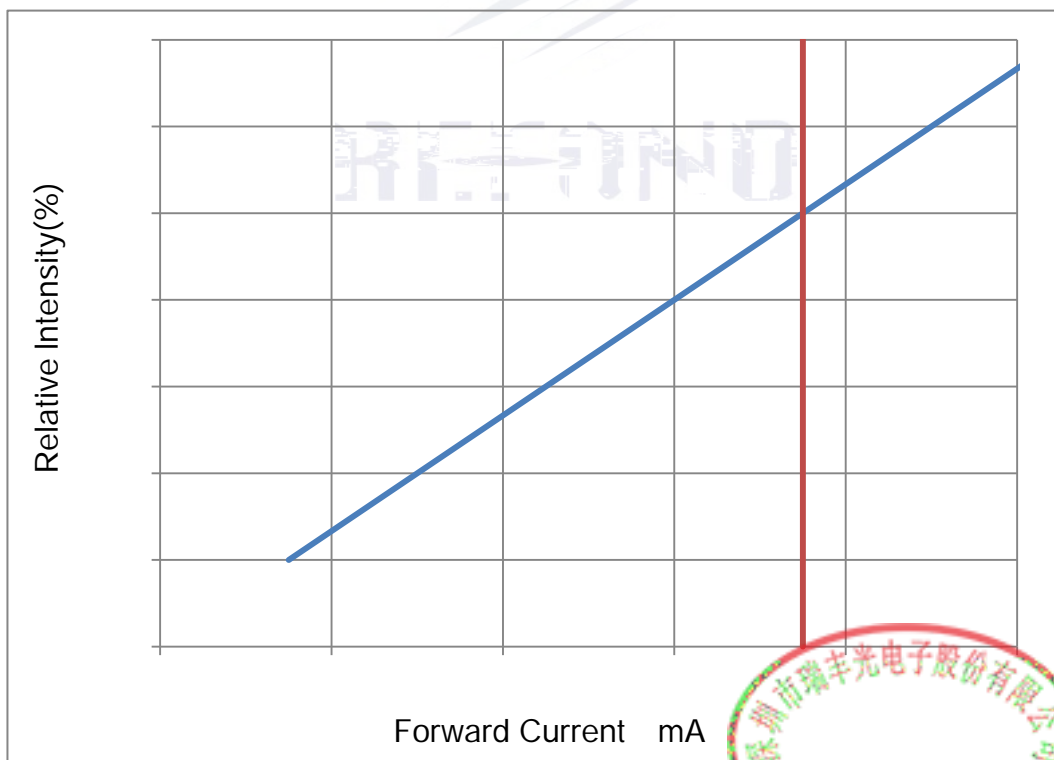
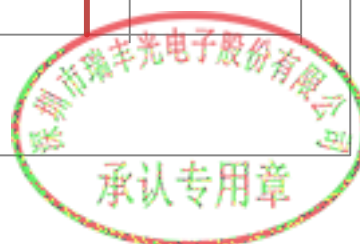

Fig. 1-8 Forward Current Vs Relative Intensity



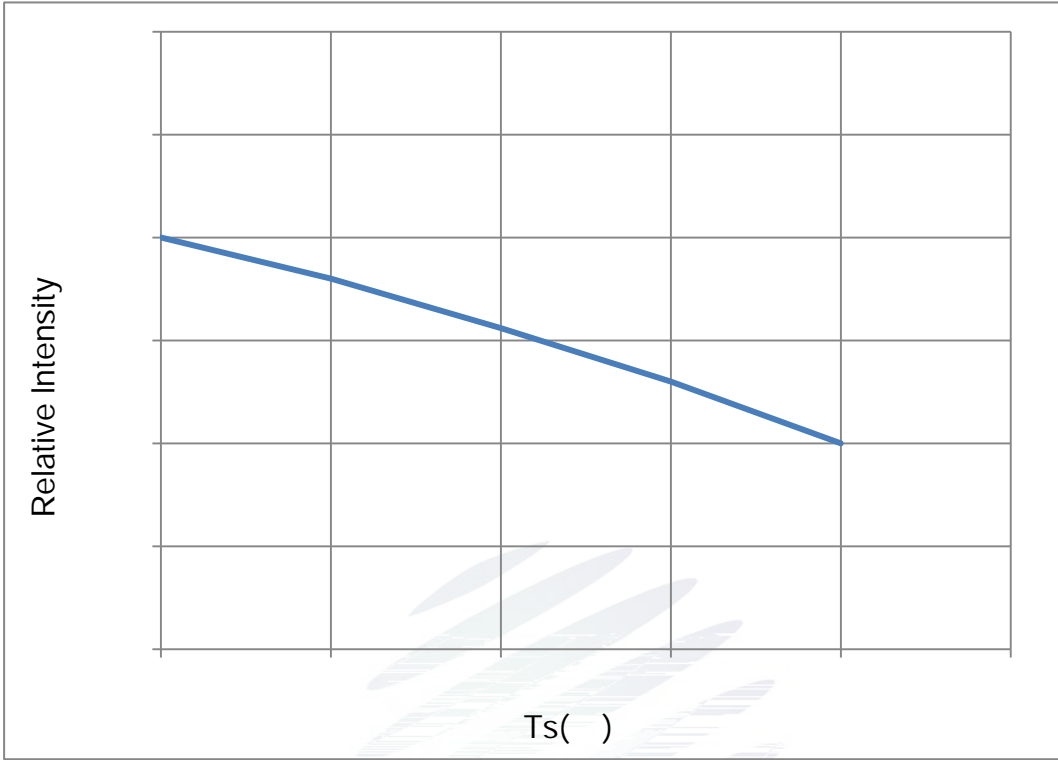

Fig. 1-9 Solder Temperature Vs Relative Intensity

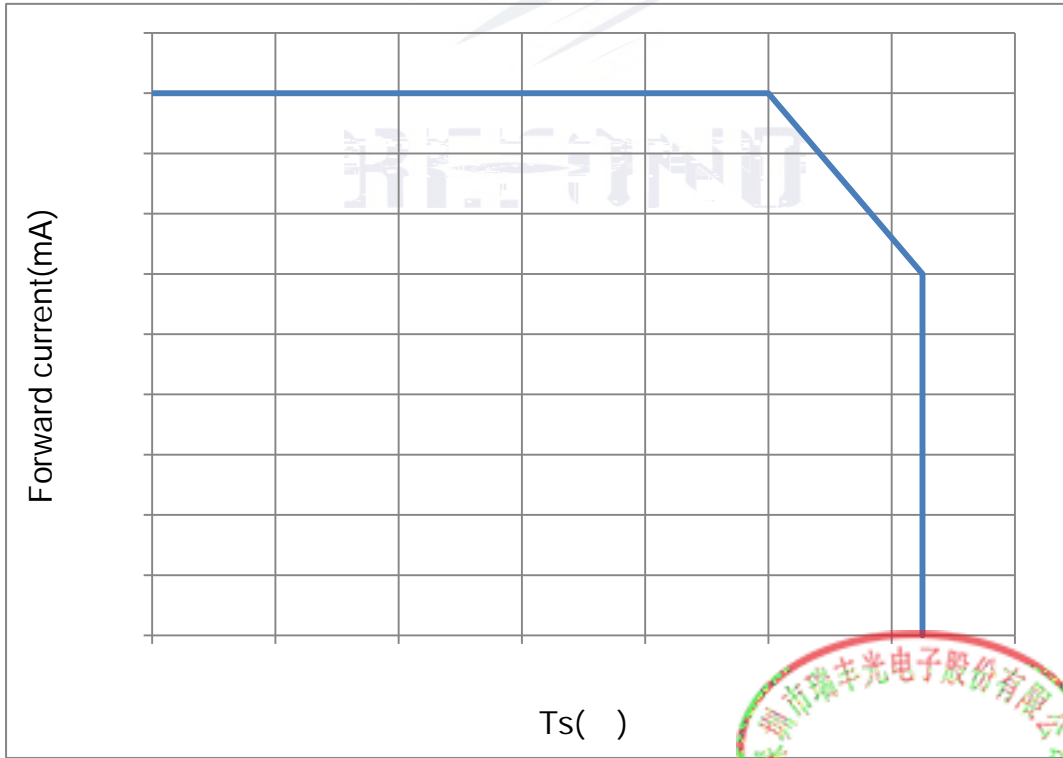
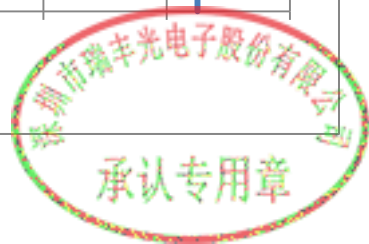

Fig. 1-10 Solder Temperature Vs Forward Current



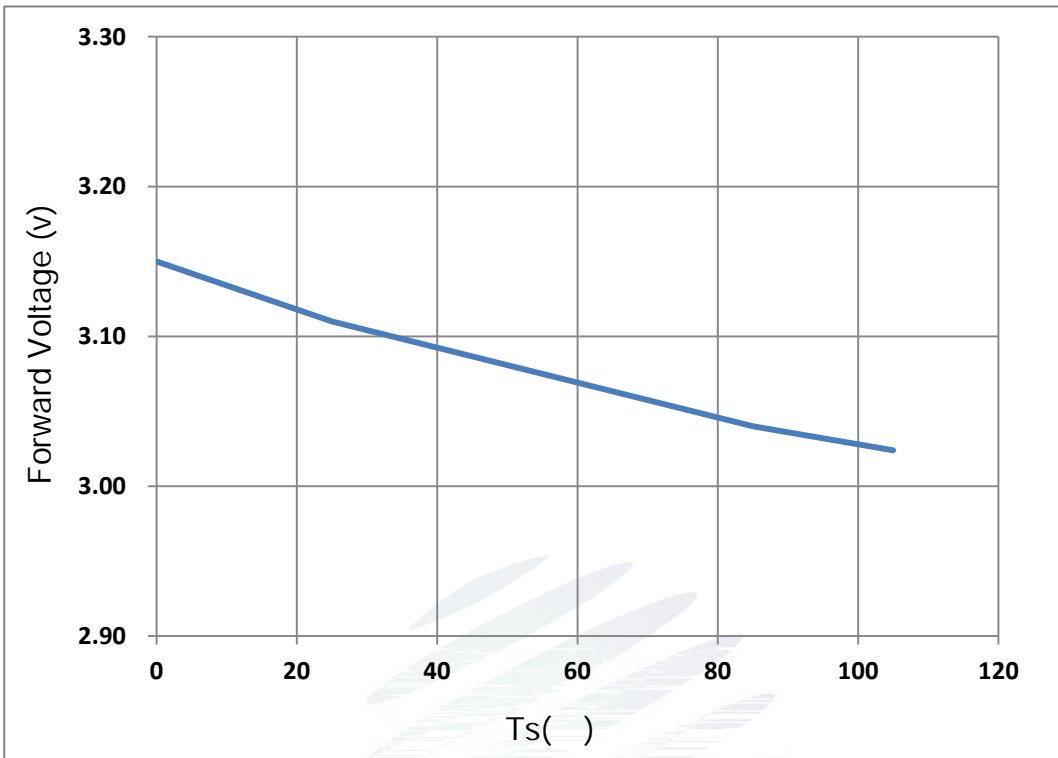

Fig. 1-11 Forward Voltage Vs Solder Temperature

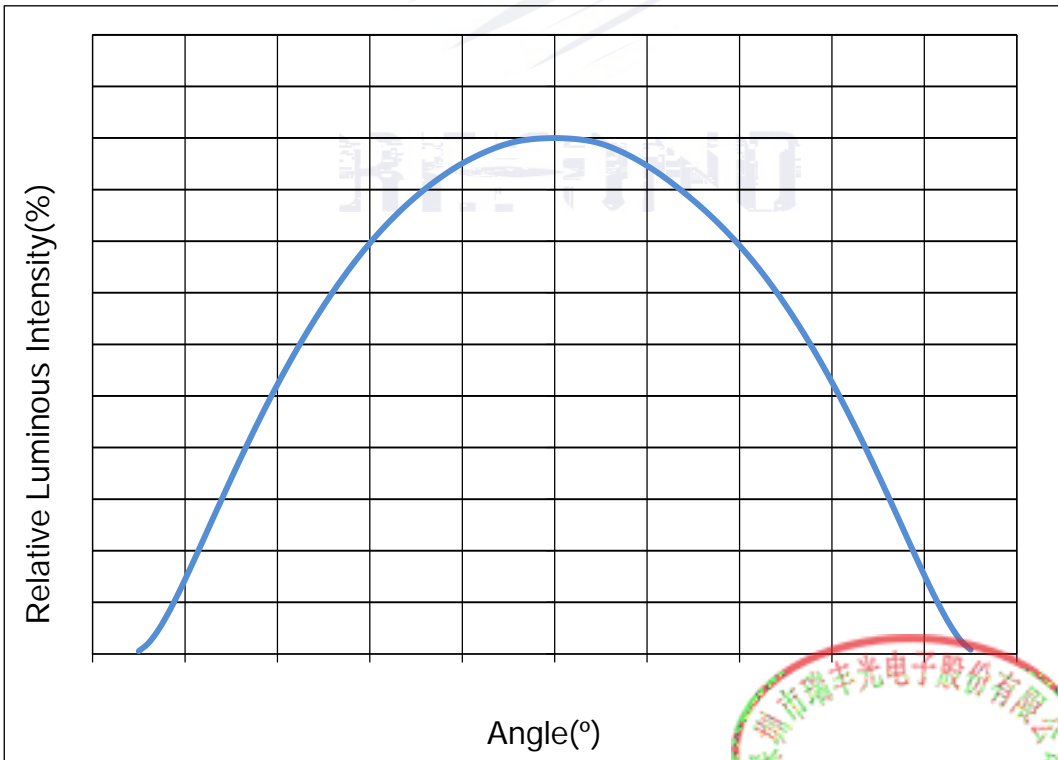

Fig. 1-12 Radiation diagram



2. Packaging

2.1 Packaging Specification

Package:4000pcs/reel.

2.1.1Carrier Tape Dimension

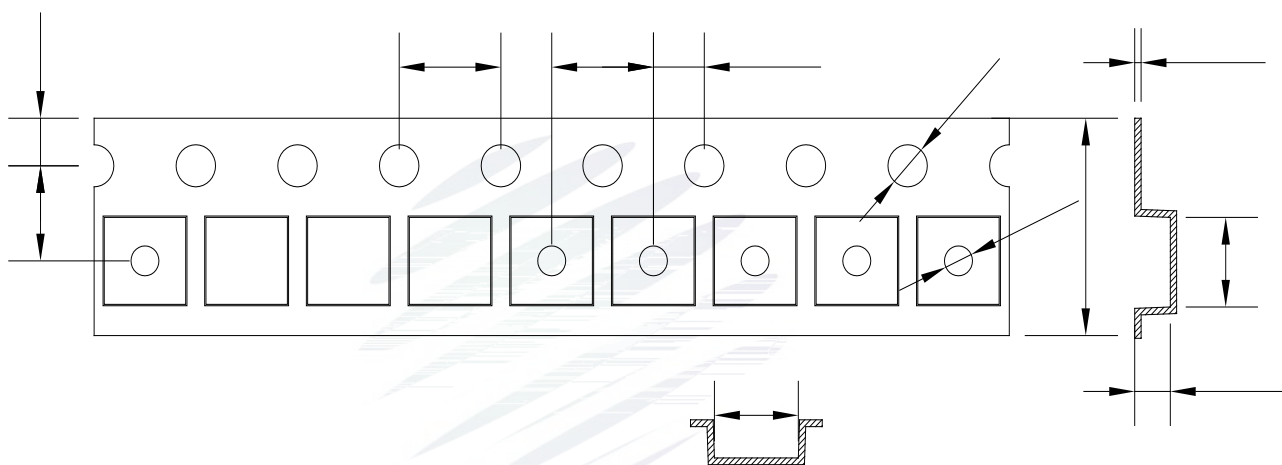

Fig.2-1 Carrier Tape Dimension

2.1.2Reel Dimension



Table 2-1Reel Dimension

| | |
|---|------------|
| A | 12±0.1mm |
| B | 180± 1mm |
| C | 60± 1mm |
| D | 13.0±0.5mm |

Fig.2-2Reel Dimension

Notes

The tolerances unless mentioned $\pm 0.1\text{mm}$. Unit : mm

± 0.1

2.1.3 Label Form Specification

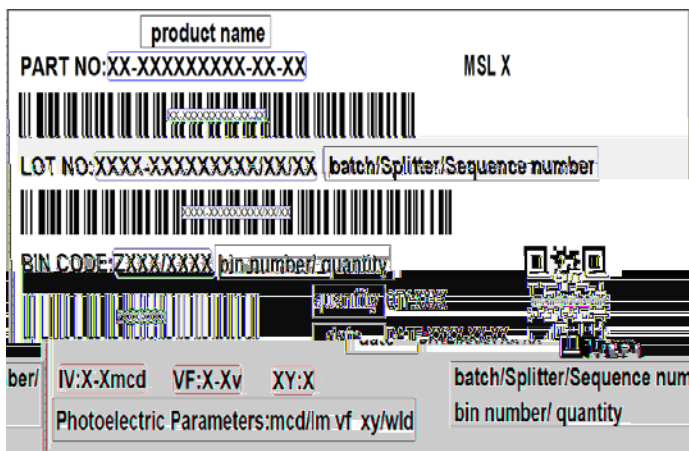

Fig. 2-3 Label Form Specification

Table 2-2 Specification

| | |
|----------------|------------------|
| PART NO. | Part Number |
| SPEC NO. | Spec Number |
| LOT NO. | Lot Number |
| BIN CODE | Bin Code |
| | Luminous flux |
| XY | Chromaticity Bin |
| V _F | Forward Voltage |
| WLD | Wavelength |
| QTY | Packing Quantity |
| DATE | Made Date |

2.2 Moisture Resistant Packing

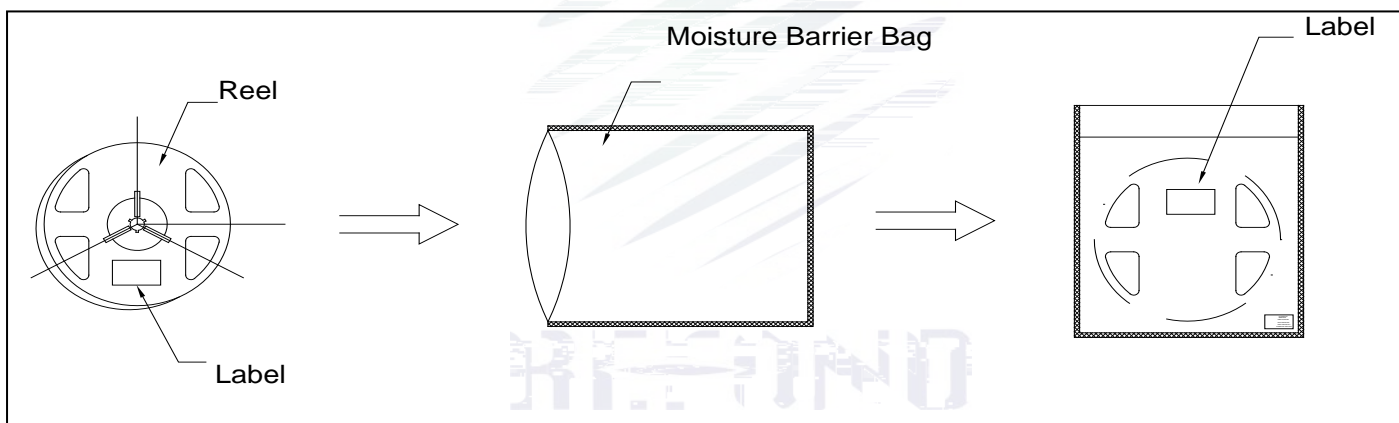

Fig.2-4 Moisture Resistant Packing

2.3 Cardboard Box

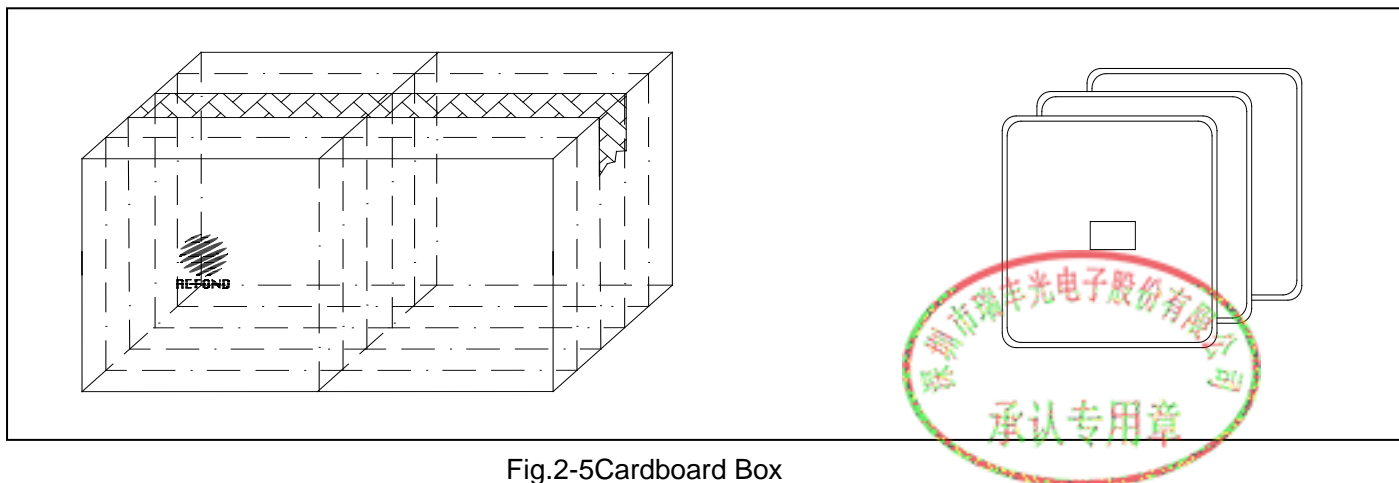

Fig.2-5 Cardboard Box

2.4 Reliability Test Items And Conditions

Table 2-3 Reliability Test Items And Conditions

| Test Items | Ref.Standard | Test Condition | Time | Quantity | Ac/Re |
|------------|--------------|----------------|------|----------|-------|
|------------|--------------|----------------|------|----------|-------|

Reflow

JESD22-B106



2.5 Criteria For Judging Damage

Table 2-4Criteria For Judging Damage

| Test Items | Symbol | Test Condition | Criteria For Judgement | |
|-----------------|--------|----------------|------------------------|-------------|
| | | | Min. | Max. |
| Forward Voltage | V_F | $I_F=150mA$ | - | U.S.L*)x1.1 |
| Reverse Current | I_R | $V_R = 5V$ | - | U.S.L*)x2.0 |
| Luminous Flux | | $I_F=150mA$ | L.S.L*)x0.7 | - |

Notes

- 1.U.S.L: Upper standard level L.S.L: Lower standard level
- 2.The above reliability tests is based on the verification of a single/strip LED of Refond's existing experimental platform,the reliability experiment was taken under good heat dissipation conditions. when customers applies the LED to the series and parallel circuit, should take consideration of all the factors such as the current, voltage distribution, heat dissipation and others. / LED
LED
- 3.The technical information shown in the data sheets is limited to the typical characteristics and circuit examples of the referenced products. It does not constitute the warranting of industrial property nor the granting of any license.



3. SMT Reflow Soldering Instructions SMT

3.1 SMT Reflow Soldering Instructions SMT

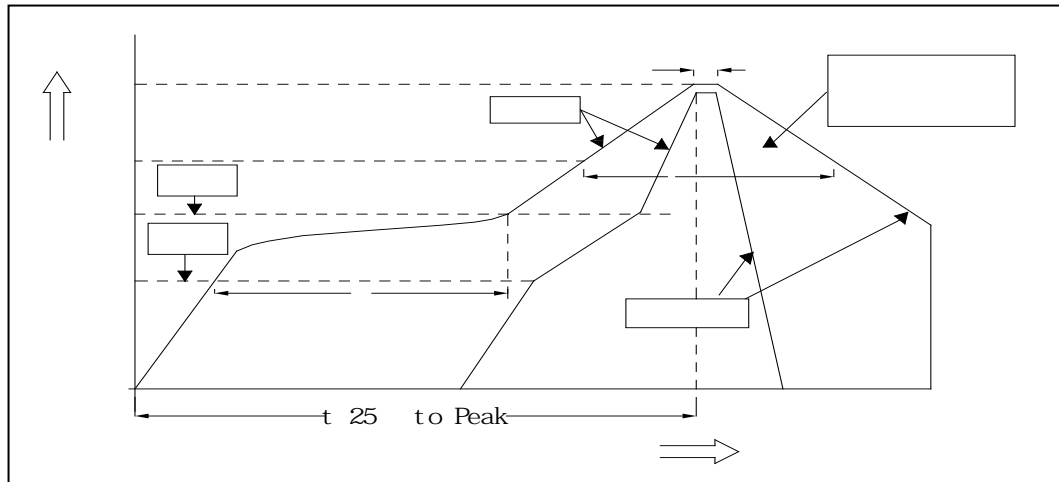
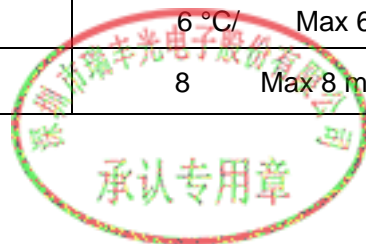

Table 3-1 Reflow parameters

| | | | |
|--|---------------------------------|----------|---------------|
| Average temperature rise speed | T_{smax} T_P | 3 °C/ s | Max 3 °C/ s |
| Preheating: minimum temperature | (T_{smin}) | 150 °C | |
| Preheating: Max temperature | (T_{smax}) | 200 °C | |
| Preheating: Time | T_{smin} T_{smax} | 60 - 120 | 60s-120s |
| Time limited to maintain high temperature: the temperature | (T_L) | 217 °C | |
| Time limited to maintain high temperature: The Time | (t_L) | 60 | Max 60s |
| Peak /Classification of temperature: | / (T_P) | 260 °C | |
| Time limit classification of peak temperature time | t_p | 10 | Max 10s |
| (T_P) 5 °C | Hold time within 5 °C | 30 | Max 30s |
| with the actual peak temperature (TP) | | | |
| Cooling speed | | 6 °C/ s | Max 6 °C/ s |
| 25 °C | Needed time from 25 °C to T_p | 8 | Max 8 minutes |



Notes

(1)Reflow soldering should not be done more than twice. If more than 24 hours between the two solderings ,LED will be damaged.

24 LED

(2)When soldering , do not put stress on the LEDs during heating.

3.1.1 Repairing

Repairing should not be done after the LEDs have been soldered. When repairing is unavoidable,a double-head soldering iron should be used (as below figure). It should be confirmed in advance whether the characteristics of LEDs will or not be damaged by repairing.

LED

LED

3.1.2 Cautions

The encapsulated material of the LEDs is silicone. Therefore the LEDs have a soft surface on the top of package. The pressure to the top surface will be impacted on the reliability of the LEDs. Precautions should be taken to avoid the strong pressure on the encapsulated part. So when use the picking up nozzle, the pressure on the silicone resin should be proper. LED

LED

(2) Components should not be mounted on warped (non coplanar) portion of PCB. After soldering, do not warp the circuit board.LED PCB

(3) Do not apply mechanical force or excess vibration during the cooling process to normal temperature after soldering. Do not rapidly cool device after soldering.



4. Handling Precautions



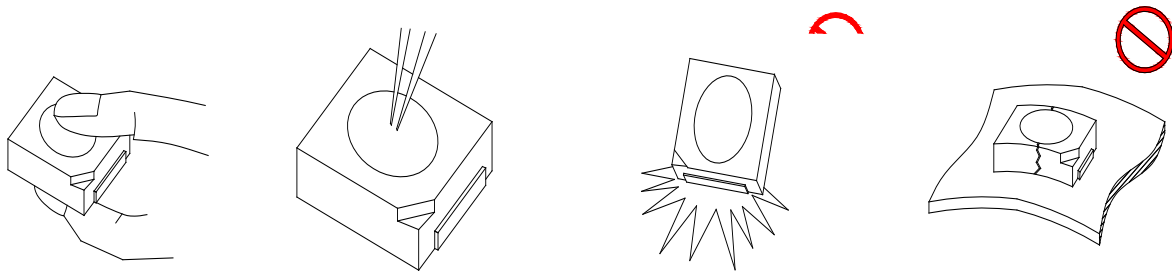

Fig 4-1Cautions

(5) In designing a circuit, the current through each LED can not exceed the absolute maximum rating specified for each LED. In the meanwhile, resistors for protection should be applied, otherwise slight voltage shift will cause big current change, burn out may happen. The driving circuit must be designed to allow forward voltage only when it is ON or OFF. If the reverse voltage is applied to LED, migration can be generated resulting in LED damage.

LED

LED

(6) Thermal Design is paramount importance because heat generation may result in the Characteristics decline, such as brightness decreased, Color change and so on. Please consider the heat generation of the LEDs when making the system design.

LED

(7) Compared to standard encapsulants, silicone is generally softer, and the surface is more likely to attract dust, requiring special care during processing. In cases where a minimal level of dirt and dust particles cannot be guaranteed, a suitable cleaning solution must be applied to the surface after the soldering of components. Refond suggests using isopropyl alcohol for cleaning. In case other solvents are used, it must be assured that these solvents do not dissolve the package or resin. Ultrasonic cleaning is not recommended. Ultrasonic cleaning may cause damage to the LED.

LED



Table 4-1 Storage

| Conditions | | Temperature | Humidity | Time |
|------------|-----------------------------|-------------|----------|--|
| Storage | Before Opening Aluminum Bag | 30 | 75% | Within 1 Year From Date |
| | After Opening Aluminum Bag | 30 | 60% | Recommended for use within 24 hours 24 |
| Baking | | 60±5 | - | 24hours 24 |

(8) If the moisture absorbent material silica gel has faded away or the LEDs have exceeded the storage time, baking treatment should be performed after unpacking and based on the following condition 60 ± 5 for above 24 hours.

60±5 24

If the package is flatulence or damaged, please notify the sales staff to assist.

(9) Similar to most Solid state devices; LEDs are sensitive to Electro-Static Discharge (ESD) and Electrical Over Stress (EOS).
LED

(10) Other points for attention, please refer to our relevant information.



Version History/

| Date | Revisor | Version | Verifier | Remarks |
|------------|-----------|---------|------------|-----------------|
| 2020/12/23 | Xian Zhou | E0 | Zhu Yiming | New issue |
| 2022/07/14 | Xian Zhou | E1 | Zhu Yiming | Template update |
| | | | | |
| | | | | |
| | | | | |
| | | | | |
| | | | | |
| | | | | |
| | | | | |
| | | | | |
| | | | | |
| | | | | |
| | | | | |
| | | | | |
| | | | | |
| | | | | |
| | | | | |
| | | | | |
| | | | | |
| | | | | |
| | | | | |
| | | | | |
| | | | | |
| | | | | |
| | | | | |
| | | | | |

