

SPECIFICATION

REFOND P/N

RF-A2E31-RGB9-W1

R&D

Mass Production

Contents

1. Description	3
1.1 General Description	3
1.2 Features	3
1.3 Application	4
1.4 Package Dimension	4
1.5 Product Parameters	5
1.6 Bin Range Of Forward Voltage and Luminous Flux	BIN 7
1.7 Typical Optical Characteristics Curves	9
2. Packaging	13
2.1 Packaging Specification	13
2.1.1 Carrier Tape Dimension	13
2.1.2 Reel Dimension	13
2.1.3 Label Form Specification	14
2.2 Moisture Resistant Packing	14
2.3 Cardboard Box	13
2.4 Reliability Test Items And Conditions	15
2.5 Criteria For Judging Damage	16
3. SMT Reflow Soldering Instructions SMT $\times vD^a \phi$	17
3.1 SMT Reflow Soldering Instructions SMT	17
4. Handling Precautions	18
4.1 Handling Precautions	18



1.3 Application

Automotive Interior Lighting.

1.4 Package Dimension

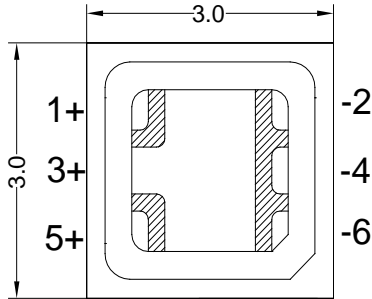

) L J 7 R S Y L H Z 1 " M ' ? ö .

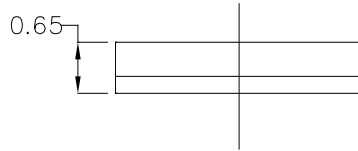

) L J 6 L G H Y L H Z x M ' ? ö .

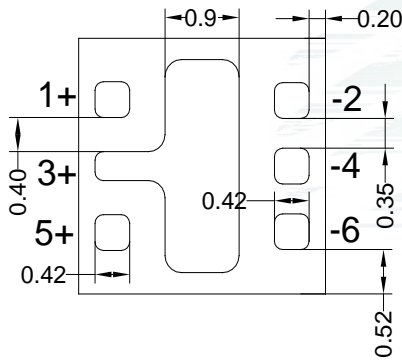

) L J % R W W R P Y L H Z 6 ü M ' ? ö .

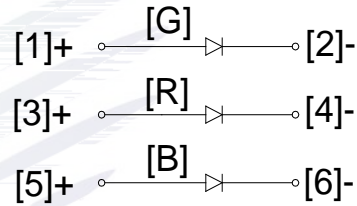

) L J 3 R O D U L W \ ± W

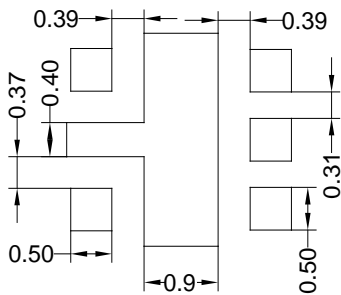

) L J 6 R O G H U L Q J S D W W H U Q V Ø 9 € :-

Notes

1. All dimensions units are millimeters.

2. All dimensions tolerances are $\pm 0.2\text{mm}$ unless otherwise noted.

± 0.2

1.5 Product Parameters

Table 1-1 Electrical / Optical Characteristics at Ts=25°C

Product	Symbol	test condition	Value			unit
			Min.	Typ.	Max.	
Forward Voltage R Ä!" A+e » Ä	Vf	I _F =60mA	2.2	---	2.8	V
Forward Voltage G Ä!" A+e » Ä	Vf	I _F =60mA	3.0	---	3.6	V
Forward Voltage B Ä!" A+e » Ä	Vf	I _F =60mA	3.0	---	3.6	V
luminous flux R Ä yFJGy Ä	-	I _F =60mA	7.0	---	11.0	lm
luminous flux G Ä yFJGy Ä	-	I _F =60mA	15.0	---	22.0	lm
luminous flux B Ä yFJGy Ä	-	I _F =60mA	3.0	---	7.0	lm
Dominant Wavelength R Ä# K- Ä	D	I _F =60mA	615	---	625	nm
Dominant Wavelength G Ä# K- Ä	D	I _F =60mA	515	---	530	nm
Dominant Wavelength B Ä# K- Ä	D	I _F =60mA	460	---	470	nm
Reverse Current Ä%?+e#q Ä	Vr=5	IR	---	---	2	uA
Viewing Angle Ä y@ Ö Ä	,	I _F =60mA	---	---	120	Deg
Thermal resistance R Ä' Lk Ä	R _{THJ-S}	I _F =60mA	---	---	55	/W
Thermal resistance G Ä' Lk Ä	R _{THJ-S}	I _F =60mA	---	---	46	/W
Thermal resistance B Ä' Lk Ä	R _{THJ-S}	I _F =60mA	---	---	43	/W



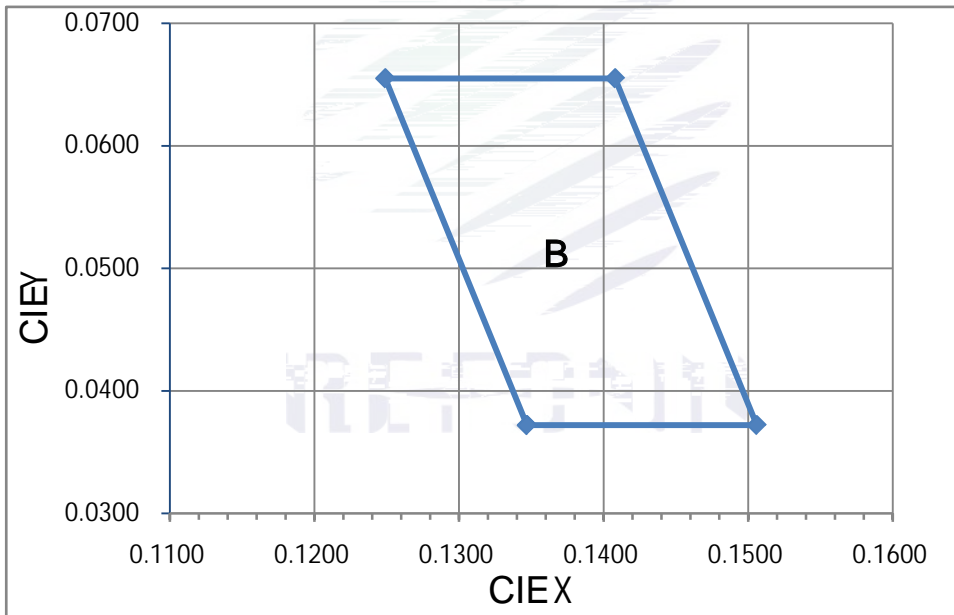
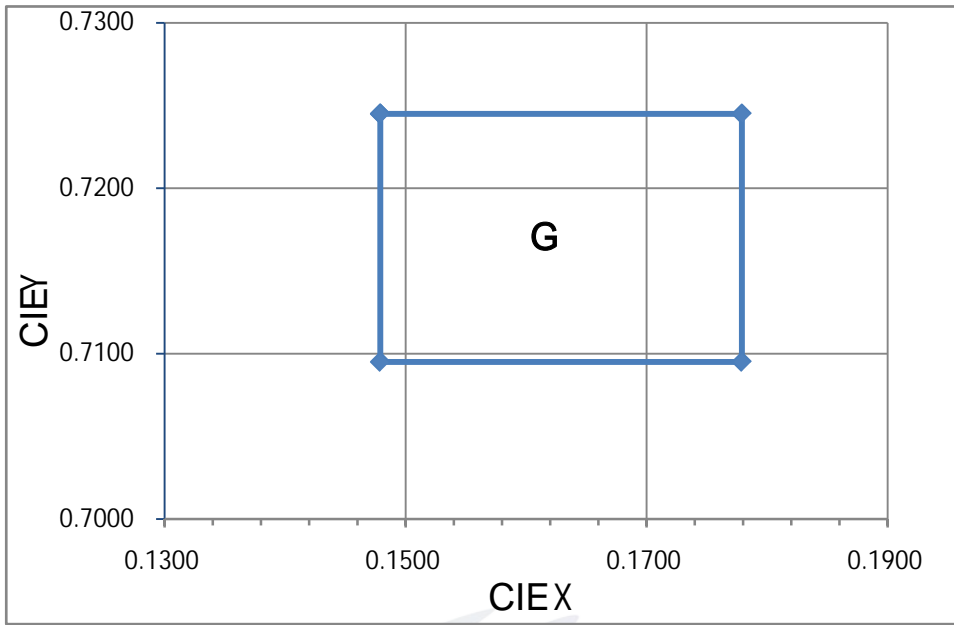

1.7 Typical Optical Characteristics Curves

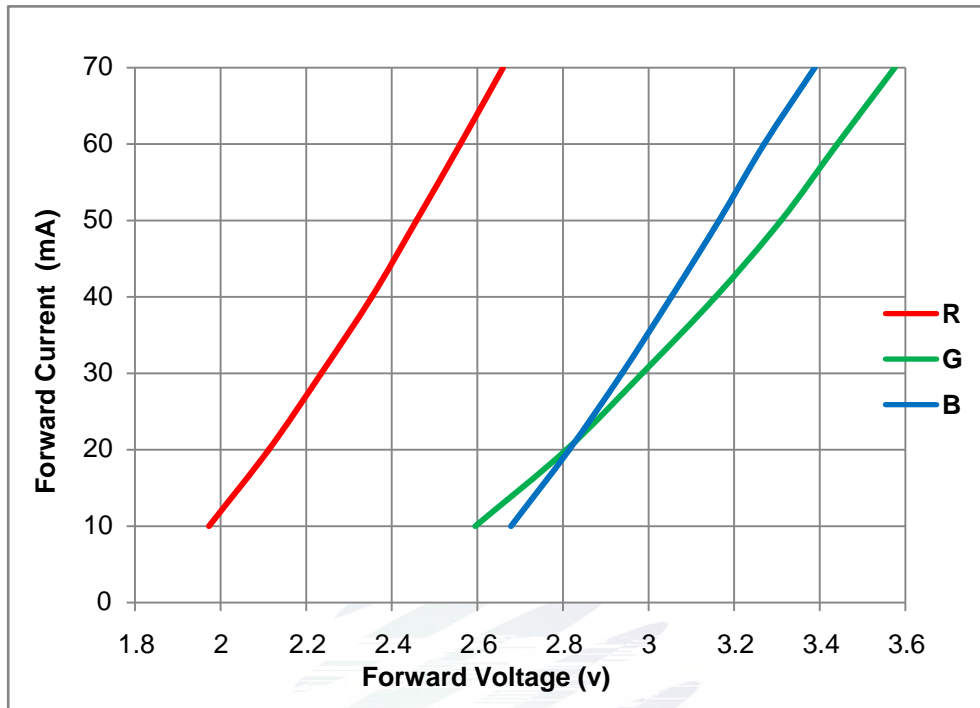

Fig. 1-7 Forward Voltage Vs Forward Current

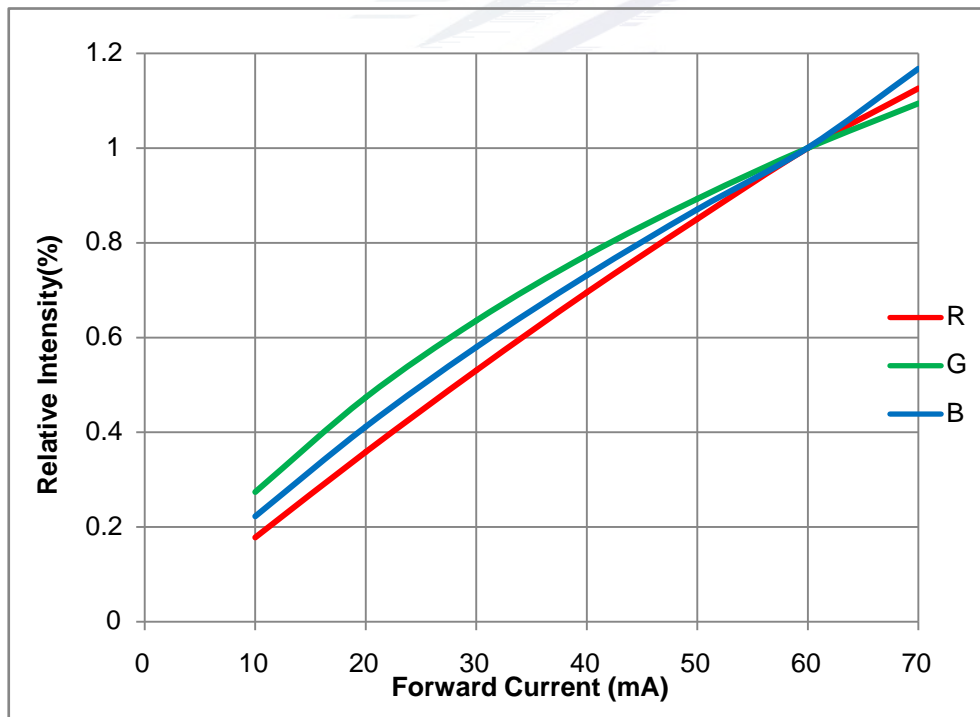

Fig. 1-8 Forward Current Vs Relative Intensity

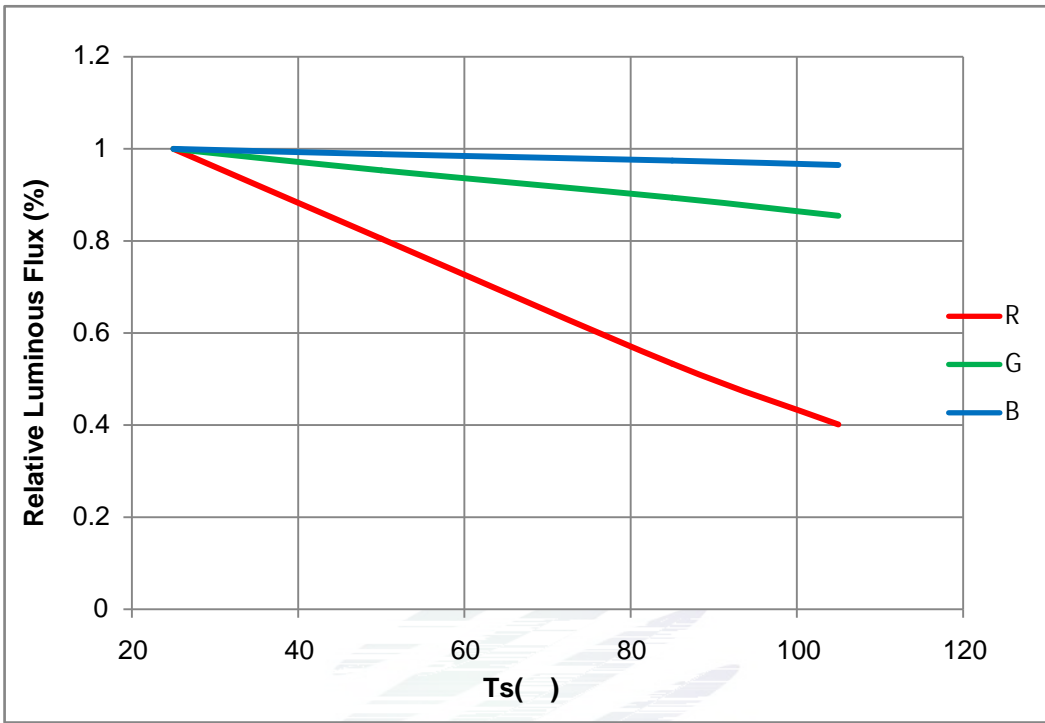

Fig. 1-9 Solder Temperature Vs Relative Intensity

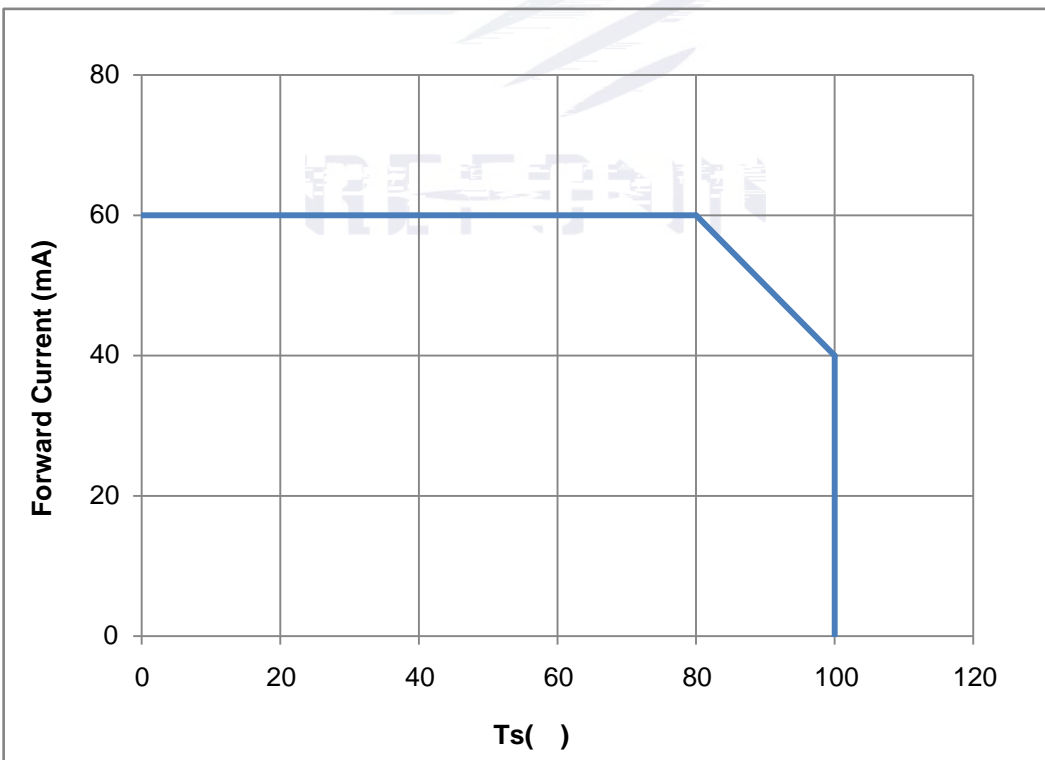

Fig. 1-10 Solder Temperature Vs Forward Current

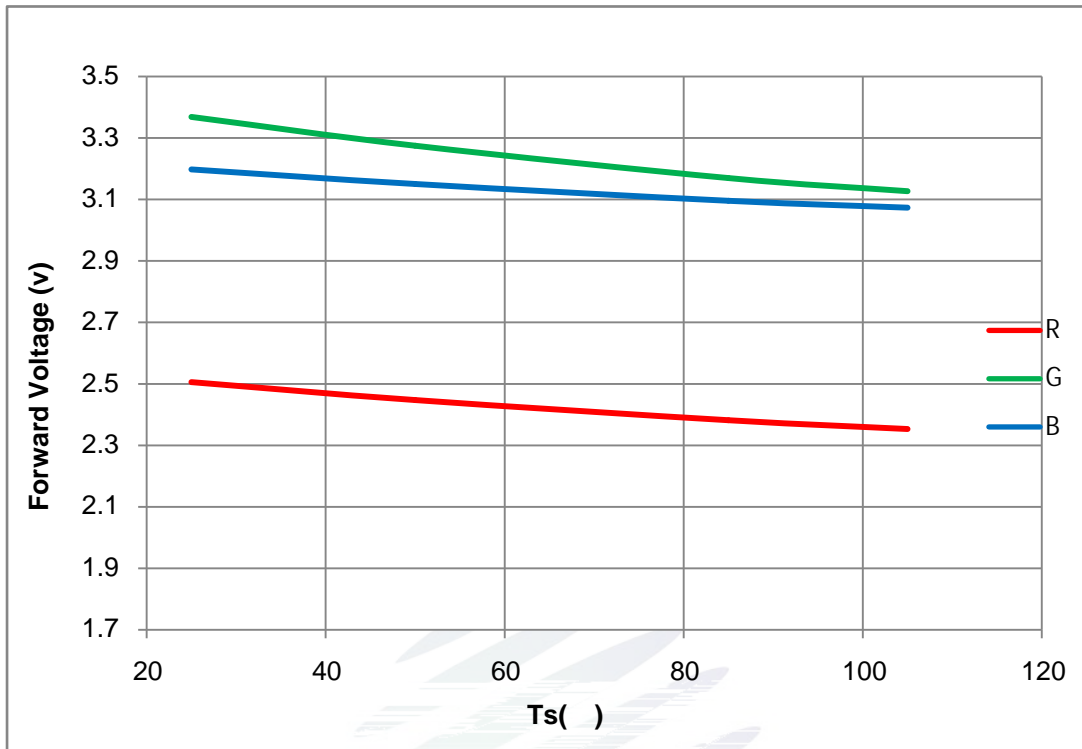

Fig. 1-11 Forward Voltage Vs Solder Temperature

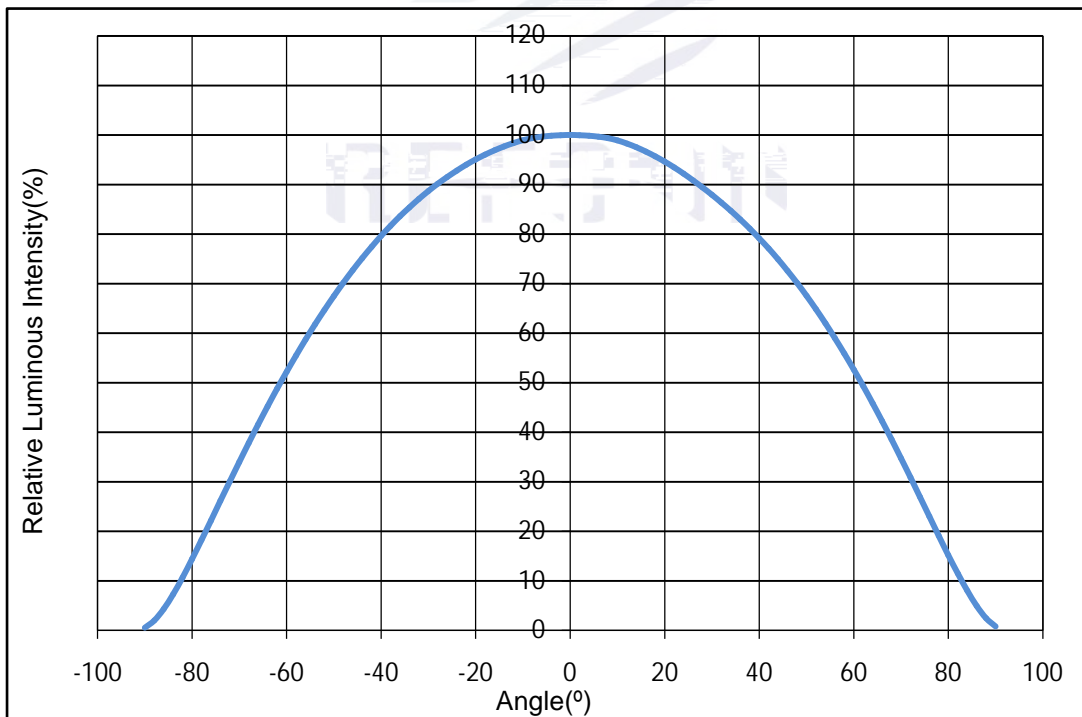

Fig. 1-12 Radiation diagram

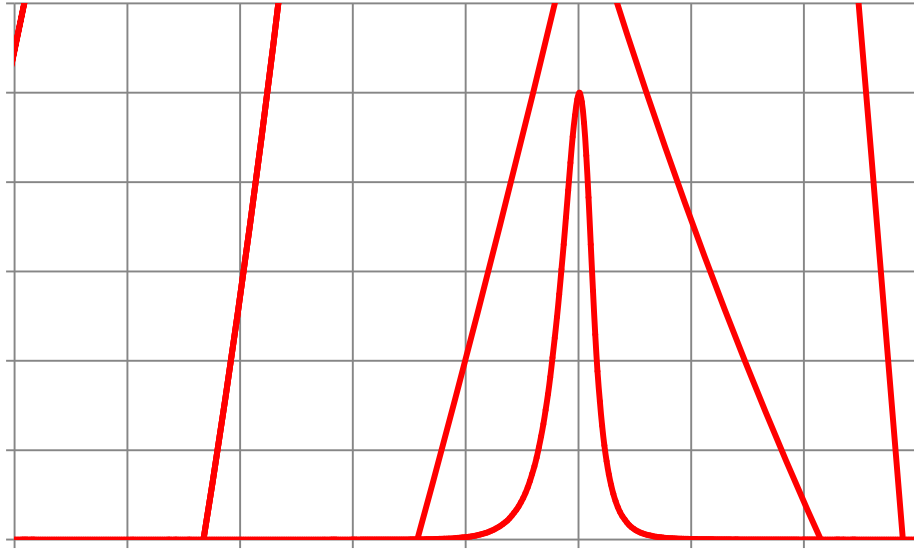
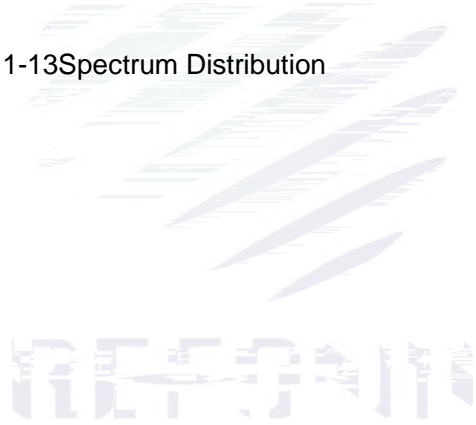

Fig. 1-13 Spectrum Distribution





2.1.3 Label Form Specification

Table 2-2 Specification

PART NO.	Part Number
SPEC NO.	Spec Number
LOT NO.	Lot Number
BIN CODE	Bin Code
N	Luminous flux
WLD	Dominant Wavelength
V _F	Forward Voltage
QTY	Packing Quantity
DATE	Made Date

Fig. 2-3 Label Form Specification

2.2 Moisture Resistant Packing

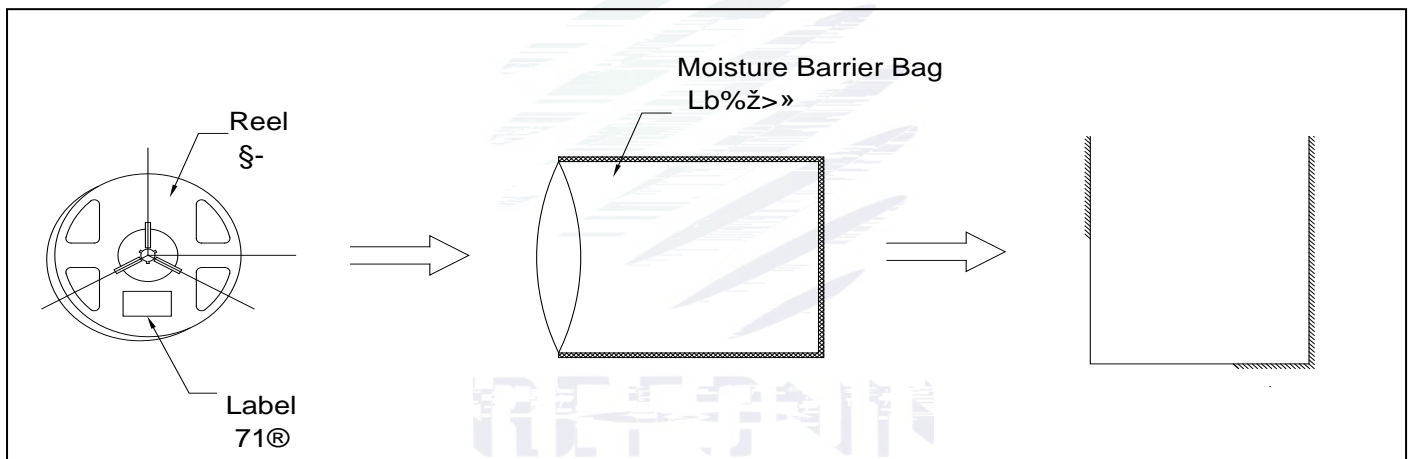

Fig.2-4 Moisture Resistant Packing eÚ? "-Xm

.3 Cardboard Box

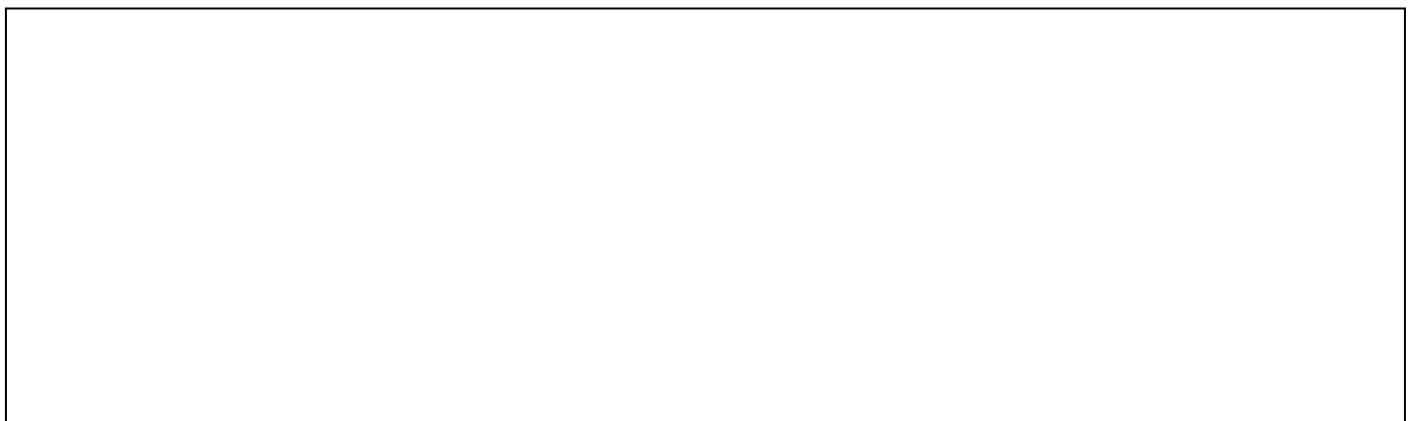

Fig.2-5 Cardboard Box "-XmN`KY

2.4 Reliability Test Items And Conditions

Table 2-3 Reliability Test Items And Conditions

TestItems	Ref.Standard	Test Condition	Time	Quantity	Ac/Re
					/



2.5 Criteria For Judging Damage

Table 2-4 Criteria For Judging Damage

Test Items	Symbol	Test Condition	Criteria For Judgement	
			Min.	Max.
Forward Voltage	V_F	$I_F=60\text{mA}$	-	U.S.L*)x1.1
Reverse Current	I_R	$V_R = 5\text{V}$	-	U.S.L*)x2.0
Luminous Flux	N	$I_F=60\text{mA}$	L.S.L*)x0.7	-

Notes

- 1.U.S.L: Upper standard level L.S.L: Lower standard level
- 2.The above reliability tests is based on the verification of a single/strip LED of Refond's existing experimental platform,the reliability experiment was taken under good heat dissipation conditions. when customers applies the LED to the series and parallel circuit, should take consideration of all the factors such as the current, voltage distribution, heat dissipation and others. / LED
LED
3. The technical information shown in the data sheets is limited to the typical characteristics and circuit examples of the referenced products. It does not constitute the warranting of industrial property nor the granting of any license.

ing Inst

ions SM

Notes

(1)Reflow soldering should not be done more than twice. If more than 24 hours between the two solderings ,LED will be damaged.

24 LED

(2)Whensoldering , do not put stress on the LEDs during heating.

Cautions

(1) The encapsulated material of the LEDs is silicone. Therefore the LEDs have a soft surface on the top of package. The pressure to the top surface will be impacted on the reliability of the LEDs. Precautions should be taken to avoid the strong pressure on the encapsulated part. So when use the picking up nozzle, the pressure on the silicone resin should be proper. LED

LED

(2) Components should not be mounted on warped (non coplanar) portion of PCB. After soldering, do not warp the circuit board.LED PCB

(3) Do not apply mechanical force or excess vibration during the cooling process to normal temperature after soldering. Do not rapidly cool device after soldering.

4. Handling Precautions

4.1 Handling Precautions

(1) LED operating environment and sulfur element composition cannot be over 100PPM in the LED mating usage material. This is provided for informational purposes only and is not a warranty or endorsement.

LED	LED	100PPM
-----	-----	--------

(2) In order to prevent external material from getting into the inside of LED, which may cause the malfunction of LED, the single content of Bromine element is required to be less than 900PPM, the single content of Chlorine element is required to be less than 900PPM, the total content of Bromine element and Chlorine element in the external materials of the application products is required to be less than 1500PPM. This is provided for informational purposes only and is not a warranty or endorsement.

LED	LED
900PPM	900PPM
1500PPM	

(3) VOCs (Volatile organic compounds) emitted from materials used in the construction of fixtures can penetrate silicone encapsulants of LEDs and discolor when exposed to heat and photonic energy. The result can be a significant loss of light output from the fixture. Knowledge of the properties of the materials selected to be used in the construction of fixtures can help prevent these issues. Refond advises against the use of any chemicals or materials that have been found or are suspected to have an adverse effect on device performance or reliability. To verify compatibility, Refond recommends that all chemicals and materials be tested in the specific application and environment for which they are intended to be used. Attaching LEDs, do not use adhesives that outgas organic vapor.

LED	LED
LED	
LED	

(4) Handle the component along the side surface by using forceps or appropriate tools; Do not directly touch or Handle the silicone lens surface, it may damage the internal circuitry.

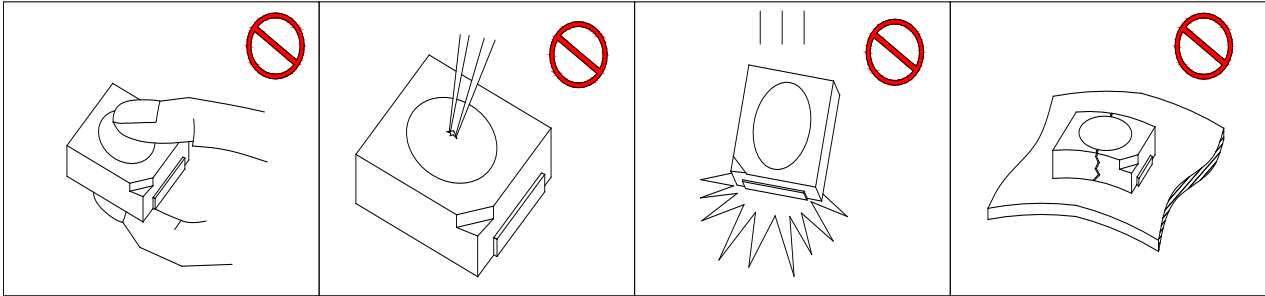

Fig 4-1 Handling Precautions

(5) In designing a circuit, the current through each LED can not exceed the absolute maximum rating specified for each LED. In the meanwhile, resistors for protection should be applied, otherwise slight voltage shift will cause big current change, burn out may happen. The driving circuit must be designed to allow forward voltage only when it is ON or OFF. If the reverse voltage is applied to LED, migration can be generated resulting in LED damage.

LED

LED

(6) Thermal Design is paramount importance because heat generation may result in the Characteristics decline, such as brightness decreased, Color change and so on. Please consider the heat generation of the LEDs when making the system design. LED

LED

(7) Compared to standard encapsulants, silicone is generally softer, and the surface is more likely to attract dust, requiring special care during processing. In cases where a minimal level of dirt and dust particles cannot be guaranteed, a suitable cleaning solution must be applied to the surface after the soldering of components. Refond suggests using isopropyl alcohol for cleaning. In case other solvents are used, it must be assured that these solvents do not dissolve the package or resin. Ultrasonic cleaning is not recommended. Ultrasonic cleaning may cause damage to the

LED.

LED

Table 4-1 Storage

Conditions		Temperature	Humidity	Time
Storage	Before Opening Aluminum Bag	30	75%	Within 1 Year From Date
	After Opening Aluminum Bag	30	60%	Recommended for use within 24 hours 1% ^Λ =2 Λ 8...\$ " G.

REFOND



Declare

This specification is written both in English and in Chinese and the latter is formal.

REFOND:WI-E-045 A/3 REV:E/0