

# SPECIFICATION

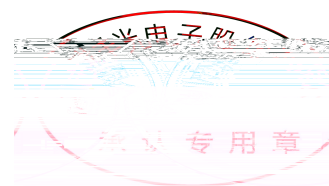

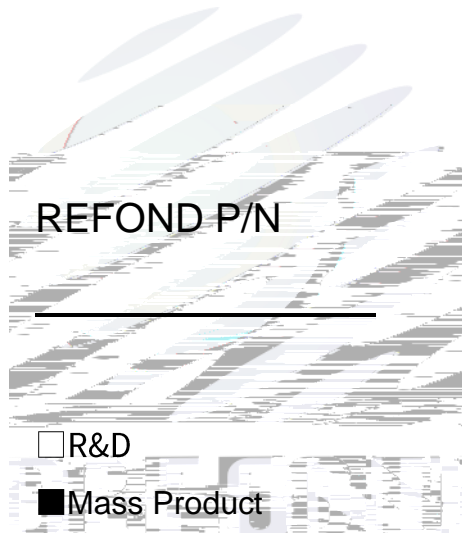

## 1. Description

### 1.1 General Description

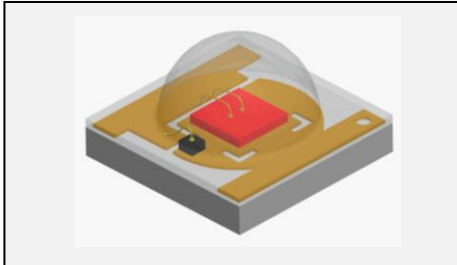

This production use the ceramics and Silicone molding package outline size 3.45X3.45X1.95mm

### 1.2 Features

- ▶ Ceramic and silicone molding package.
- ▶ Viewing angle:120°.
- ▶ Suitable for all SMT assembly and solder process.
- ▶ Available on tape and reel.
- ▶ Moisture sensitivity level: Level 3.
- ▶ RoHS compliant.

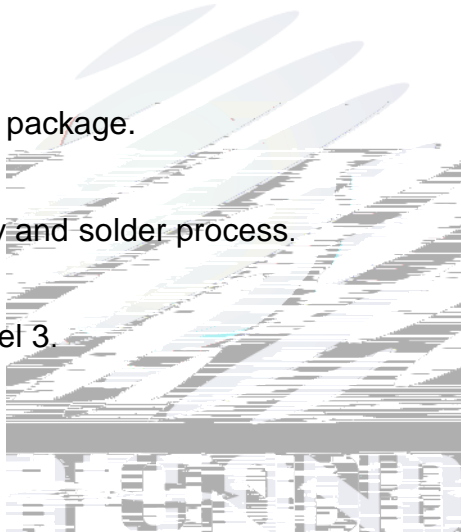

### 1.3 Application

- ▶ Flower production.
- ▶ Tissue culture.
- ▶ Plant factory.
- ▶ Refreshment.
- ▶ General use.

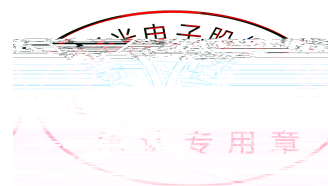

## 1.4 Package Dimension

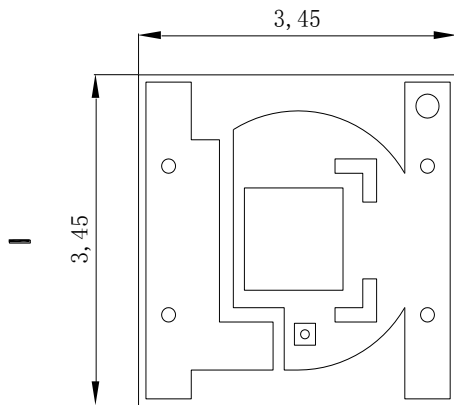

Fig.1-1 Top view

+

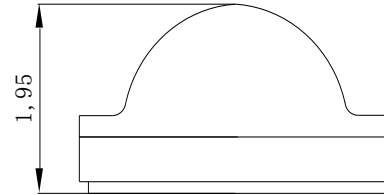

Fig.1-2 Side view

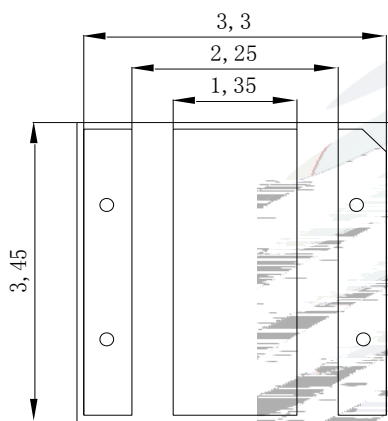

Fig.1-3 Bottom view

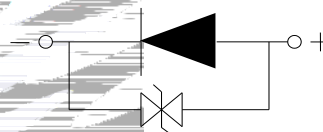

Fig.1-4 Polarity

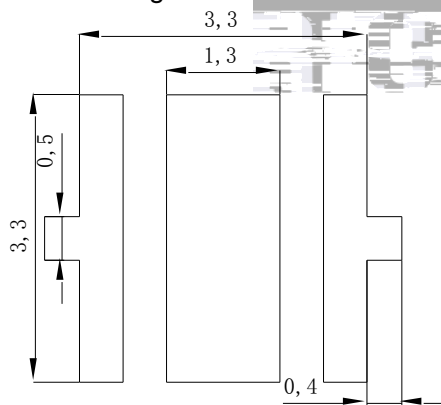

Fig.1-5 Soldering patterns

### Notes:

1. All dimensions units are millimeters.
2. All dimensions tolerances are  $\pm 0.2\text{mm}$  unless otherwise noted.

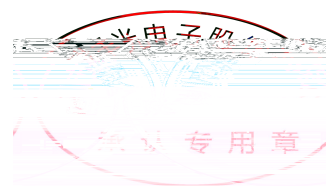

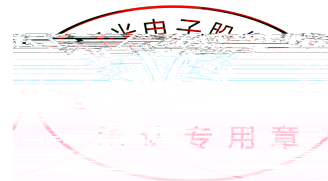

Table 1-2 Absolute Maximum Ratings at Ts=25°C

| Parameter                     | Symbol           | Rating     | Units |
|-------------------------------|------------------|------------|-------|
| Power Dissipation             | P <sub>D</sub>   | 3          | W     |
| Forward Current               | I <sub>F</sub>   | 700        | mA    |
| Peak Forward Current          | I <sub>FP</sub>  | 700        | mA    |
| Reverse Voltage               | V <sub>R</sub>   | 5          | V     |
| Electrostatic Discharge (HBM) | E <sub>SD</sub>  | 2000       | V     |
| Operating Temperature         | T <sub>OPR</sub> | -40 ~ +85  | °C    |
| Storage Temperature           | T <sub>OPR</sub> | -40 ~ +100 | °C    |
| Junction Temperature          | T <sub>J</sub>   | 115        | °C    |

Notes:

- 1/10 Duty cycle, 0.1ms pulse width.
- The above forward voltage measurement allowance tolerance is ±0.1V.
- The above wavelength measurement allowance tolerance is ±2nm.
- The above radiation flux measurement allowance tolerance ±10%.
- Care is to be taken that power dissipation does not exceed the absolute maximum rating of the product.
- All measurements were made under the standardized environment of Refond.
- When the LEDs are in operation the maximum current should be decided after measuring the package temperature, junction temperature should not exceed the maximum rate.
- ESD yield is over 90% at 2000V ESD (HBM). ESD protection during products handing is needed.



## 1.6 Typical optical characteristics curves

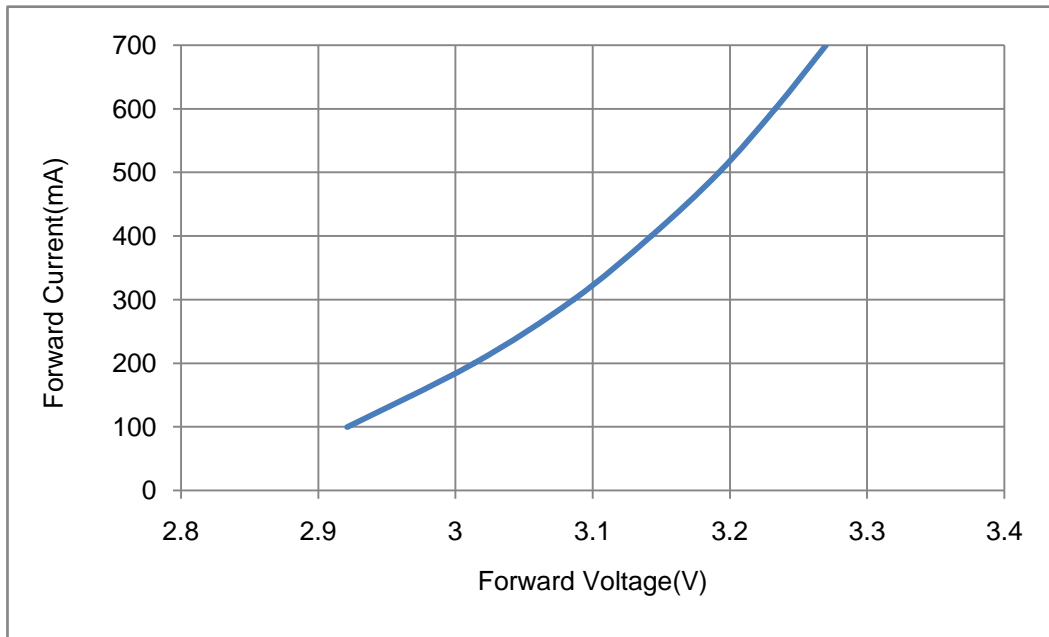

Fig.1- Forward Voltage Vs. Forward Current

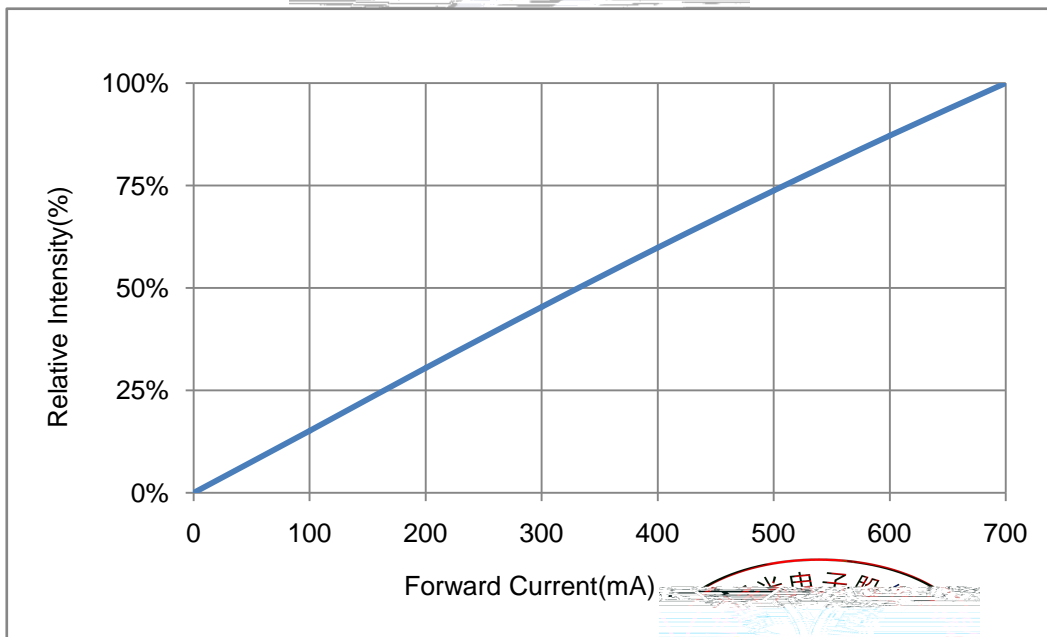

Fig.2- Forward Current Vs. Relative Power

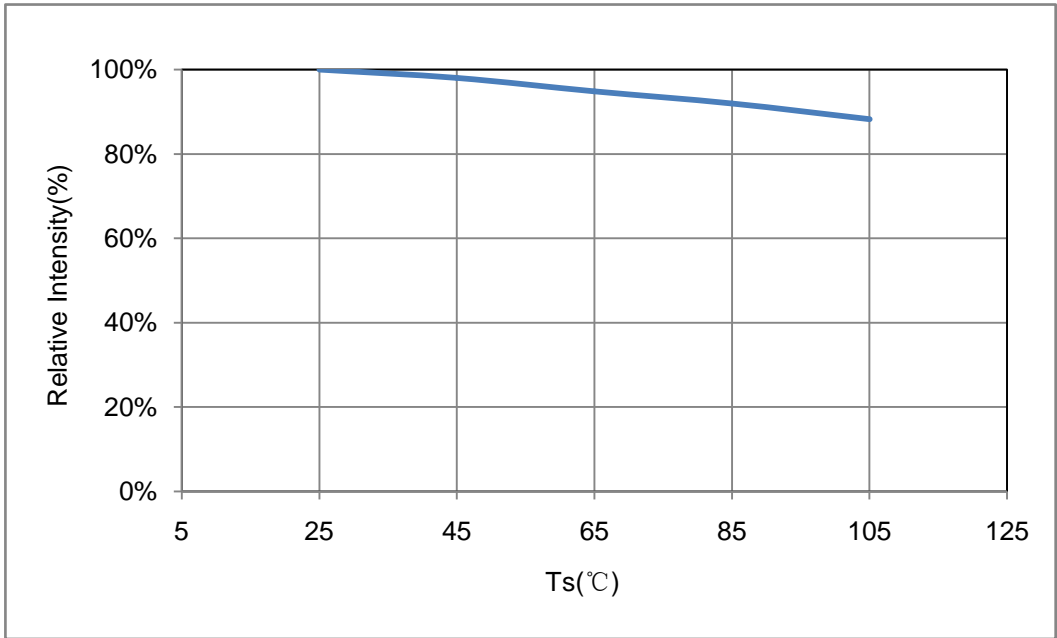

Fig.3-Solder Temperature VS. Relative Power

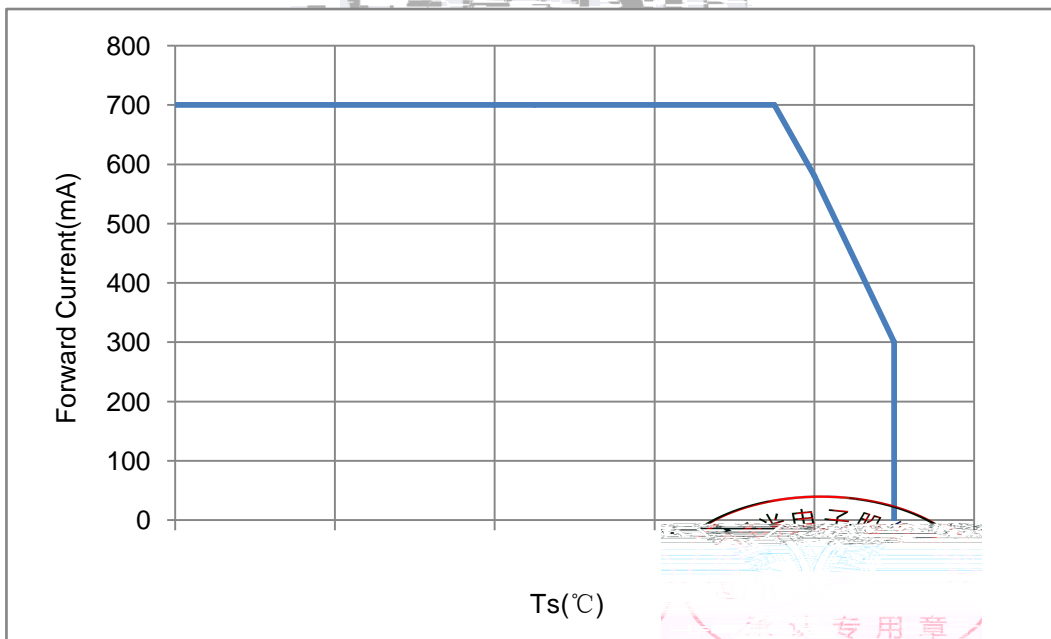
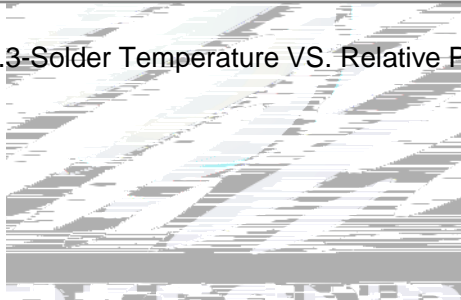

Fig.4-Ts Temperature VS. Forward Current



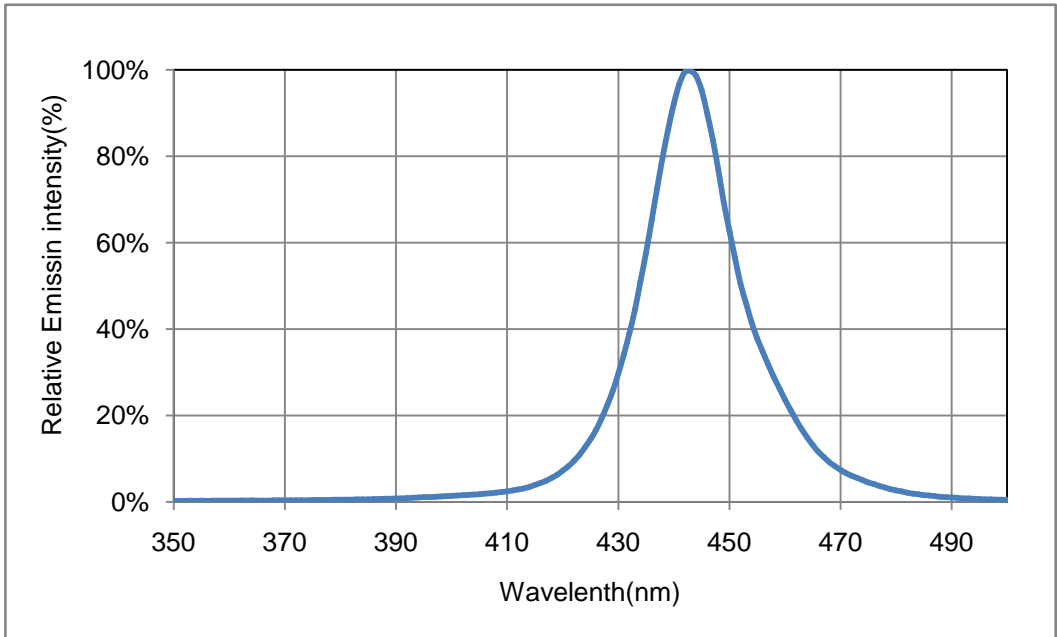

Fig.5-Spectrum Distribution

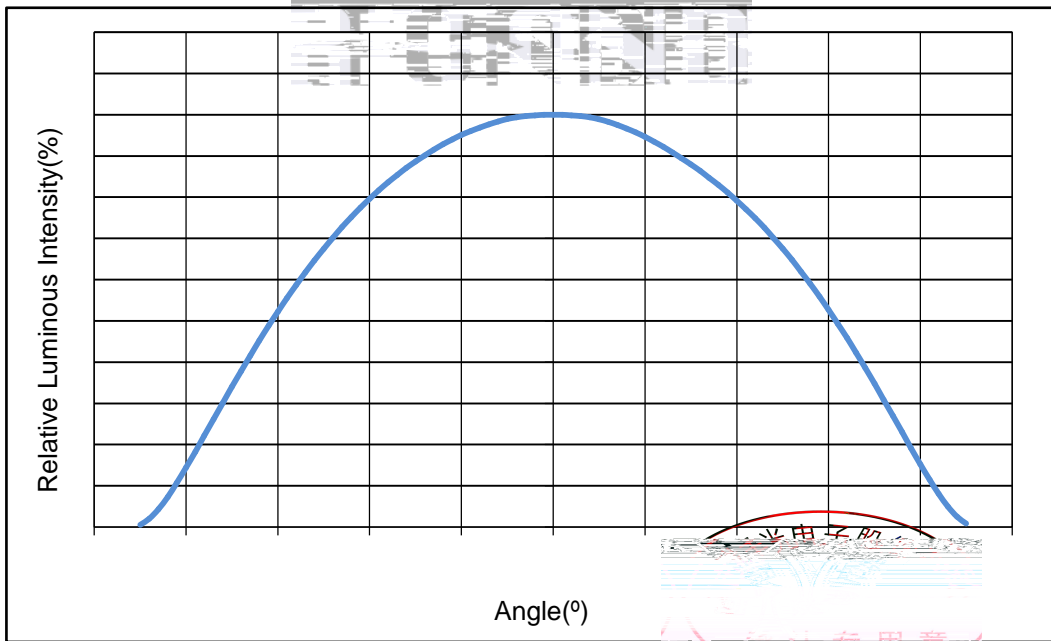

Fig.6- Radiation Diagram

## 2. Packaging

### 2.1 Packaging Specification

Package:1000pcs/reel.

#### 2.1.1 Carrier Tape Dimension

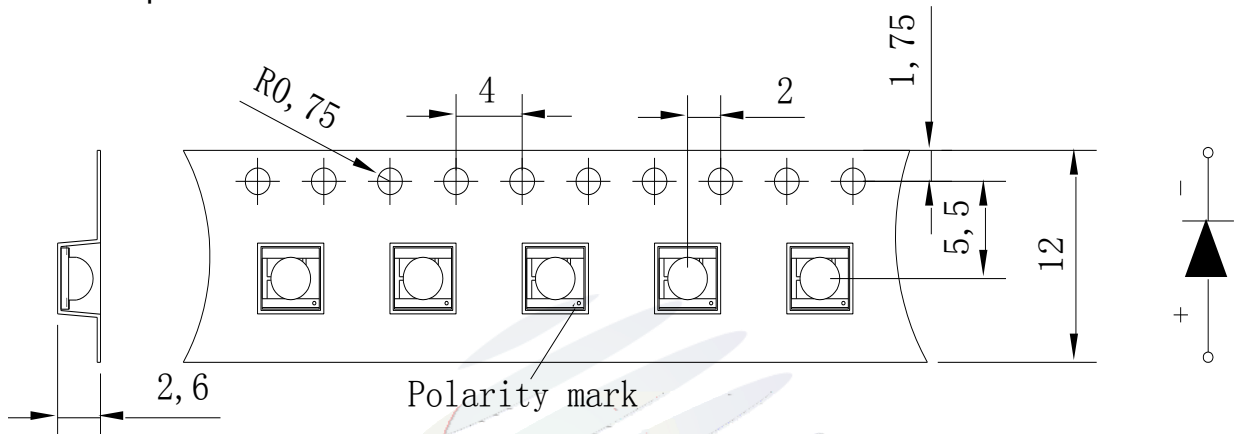
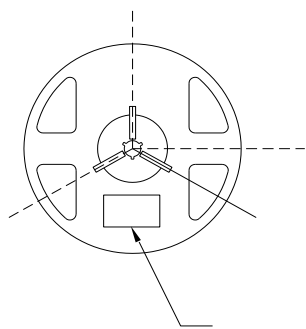

Fig.2-1 Carrier Tape Dimension

#### 2.1.2 Reel Dimension



Label

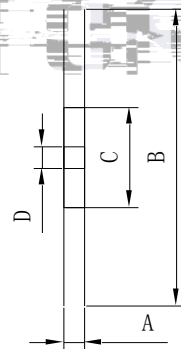

Table 2-1 Reel Dimension

|   |            |
|---|------------|
| A | 12±0.1mm   |
| B | 178±1mm    |
| C | 60±1mm     |
| D | 13.0±0.5mm |

Fig.2-2 Reel Dimension

Notes:

The tolerances unless mentioned ±0.1mm. Unit : mm .

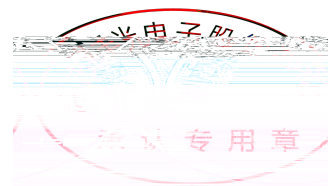

### 2.1.3 Label Form Specification

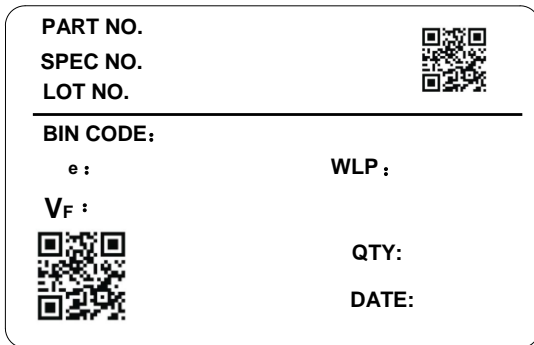

Fig. 2-3 Label Form Specification

Table 2-2 Label Form Specification

|          |                  |
|----------|------------------|
| PART NO. | Part Number      |
| SPEC NO. | Spec Number      |
| LOT NO.  | Lot Number       |
| BIN CODE | Bin Code         |
| $\Phi_e$ | Radiation flux   |
| $V_F$    | Forward Voltage  |
| WLP      | Wavelength       |
| QTY      | Packing Quantity |
| DATE     | Made Date        |

### 2.2 Moisture Resistant Packing

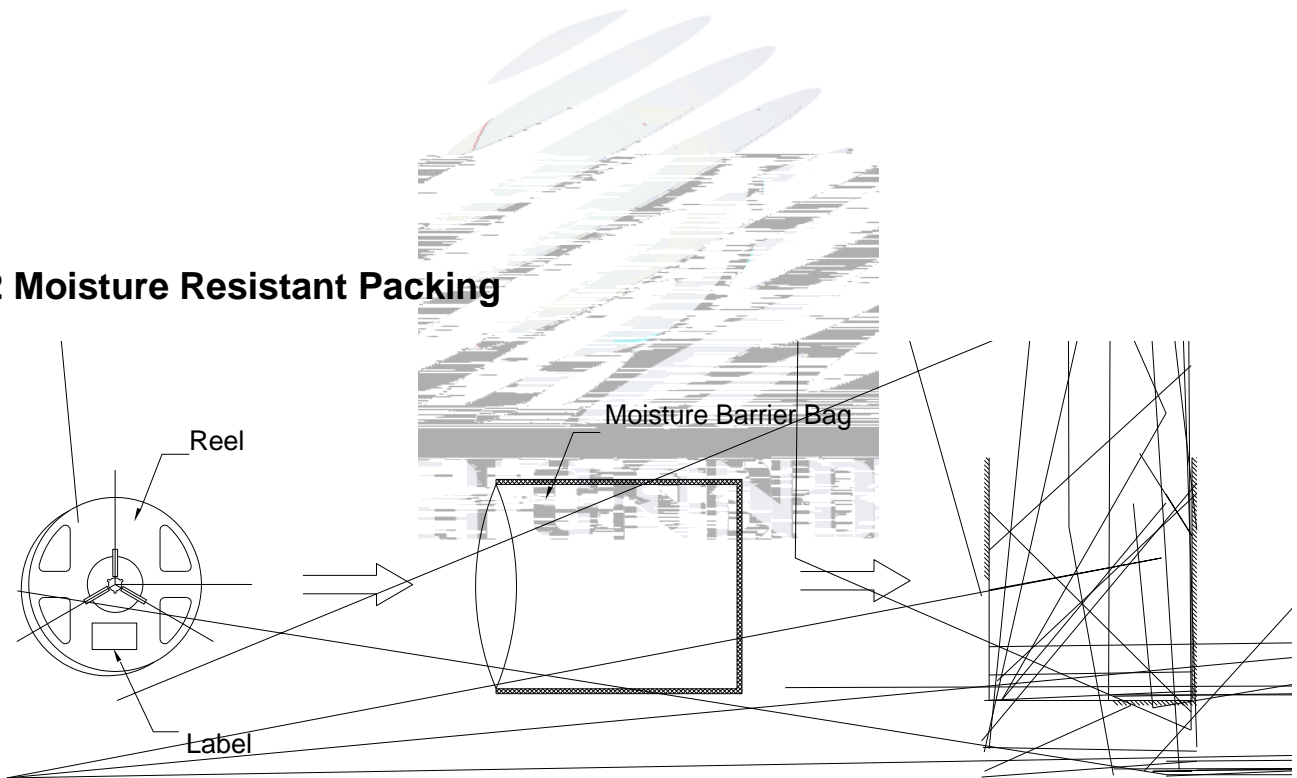
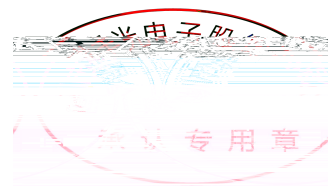

Fig.2-4 Moisture Resistant Packing Process



## 2.3 Cardboard Box

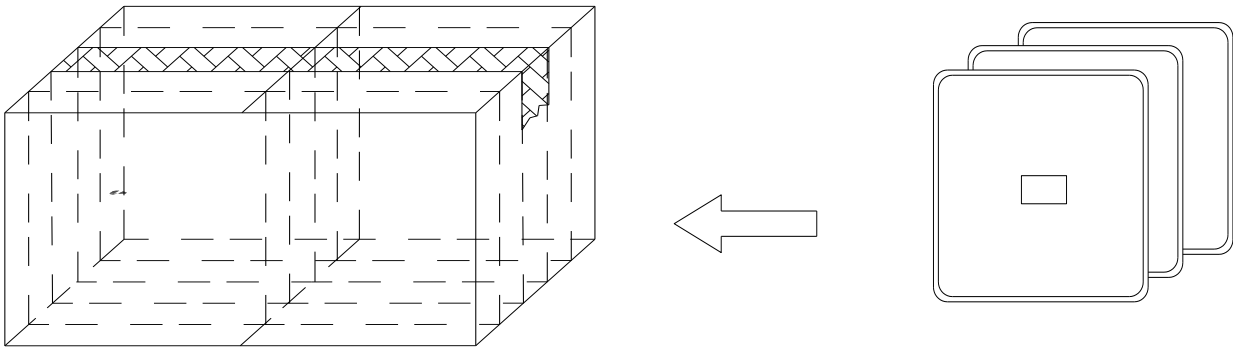

Fig.2-5 Cardboard Box

## 2.4 Reliability Test Items And Conditions

Table 2-3 Reliability Test Items And Conditions

| Test Items               | Ref.Standard | Test Condition                                | Time       | Quantity | Ac/Re |
|--------------------------|--------------|---|------------|----------|-------|
| Reflow                   | JESD22-B106  | Temp:260°C max<br>T=10 sec                    | 3times.    | 10Pcs.   | 0/1   |
| Temperature Cycle        | JESD22-A104  | 100°C 30 min.<br>↑↓5 min<br>-40°C 30 min.     | 300 Cycles | 10Pcs.   | 0/1   |
| Thermal Shock            | JESD22-A106  | -40°C 15min<br>↑↓10s<br>100°C 15min           | 300 Cycles | 10Pcs.   | 0/1   |
| High Temperature Storage | JESD22-A103  | Temp:100°C                                    | 1000Hrs.   | 10Pcs.   | 0/1   |
| Low Temperature Storage  | JESD22-A119  | Temp:-40°C                                    | 1000Hrs.   | 10Pcs.   | 0/1   |
| Life Test                | JESD22-A108  | T <sub>a</sub> =25°C<br>I <sub>F</sub> =700mA | 1000Hrs.   | 10Pcs.   | 0/1   |

## 2.5 Criteria For Judging Damage

Table 2-4 Criteria For Judging Damage

| Test Items         | Symbol   | Test Condition | Criteria For Judgement |             |
|--------------------|----------|----------------|------------------------|-------------|
|                    |          |                | Min.                   | Max.        |
| Forward Voltage    | $V_F$    | $I_F=700mA$    | -                      | U.S.L*)x1.1 |
| Reverse Current    | $I_R$    | $V_R = 5V$     | -                      | U.S.L*)x2.0 |
| Total radiant flux | $\Phi_e$ | $I_F=700mA$    | L.S.L*)x0.7            | -           |

Notes:

1. U.S.L: Upper standard leve. L.S.L: Lower standard level.
2. The above reliability tests is based on the verification of a single/strip LED of Refond's existing experimental platform, the reliability experiment was taken under good heat dissipation conditions. when customers applies the LED to the series and parallel circuit, should take consideration of all the factors such as the current, voltage distribution, heat dissipation and others.
3. The technical information shown in the data sheets is limited to the typical characteristics and circuit examples of the referenced products. It does not constitute the warranting of industrial property nor the granting of any license.

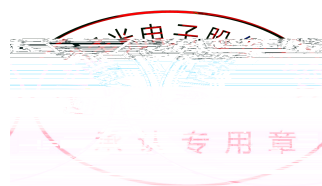

### 3. SMT Reflow Soldering Instructions SMT

#### 3.1 SMT Reflow Soldering Instructions SMT

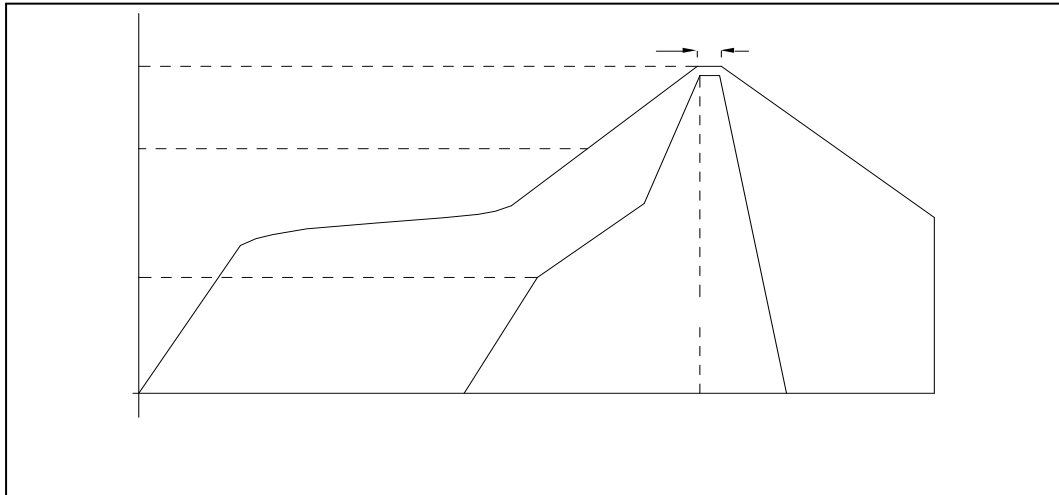

Fig.3-1 SMT Reflow Soldering Instructions SMT

Table 3-1 SMT Reflow Soldering Instructions SMT

|  |             |
|--|-------------|
| Average temperature rise speed ( $T_{smax}$ )                        | Max 3 °C/ s |
| Preheating: minimum temperature ( $T_{smin}$ )                       | 150 °C      |
| Preheating: Max temperature ( $T_{smax}$ )                           | 200 °C      |
| Preheating: Time ( $T_{smin} - T_{smax}$ )                           | 60s-120s    |
| Time limited to maintain high temperature: the temperature ( $T_L$ ) | 217 °C      |
| Time limited to maintain high temperature: The Time ( $t_L$ )        | Max 60s     |
| Peak /Classification of temperature: ( $T_P$ )                       | 260 °C      |
| Time limit classification of peak temperature time ( $t_p$ )         | Max 10s     |
| Hold time within 5 °C with the actual peak temperature ( $T_P$ )     | Max 30s     |
| Cooling speed  | Max 6 °C/ s |



(2) In order to prevent external material from getting into the inside of LED, which may cause the malfunction of LED, the single content of Bromine element is required to be less than 900PPM, the single content of Chlorine element is required to be less than 900PPM, the total content of Bromine element and Chlorine element in the external materials of the application products is required to be less than 1500PPM.

( 5(VP)-2O Cs (til-41(e)4(o))TJETBT1 0 0 1130.346 536.1 Tm[r]3ganui cem ited rom materials io the r3(duc)-11(t)5(i)-4



prnvi om iofational urposeso and



(6) Thermal Design is paramount importance because heat generation may result in the Characteristics decline, such as brightness decreased, Color change and so on. Please consider the heat generation of the LEDs when making the system design.

(7) Compared to standard encapsulants, silicone is generally softer, and the surface is more likely to attract dust, requiring special care during processing. In cases where a minimal level of dirt and dust particles cannot be guaranteed, a suitable cleaning solution must be applied to the surface after the soldering of components. Refond suggests using isopropyl alcohol for cleaning. In case other solvents are used, it must be assured that these solvents do not dissolve the package or resin. Ultrasonic cleaning is not recommended. Ultrasonic cleaning may cause damage to the LED.

Table 4-1 Storage

| Conditions |                             | Temperature                | Humidity    | Time                    |
|------------|-----------------------------|----------------------------|-------------|-------------------------|
| Storage    | Before Opening Aluminum Bag | $\leq 30^{\circ}\text{C}$  | $\leq 75\%$ | Within 1 Year From Date |
|            | After Opening Aluminum Bag  | $\leq 30^{\circ}\text{C}$  | $\leq 60\%$ | 24hours                 |
| Baking     |                             | $60 \pm 5^{\circ}\text{C}$ |             |                         |



