

Specification

1q 4. 24 533.4 6' 37 36 Tf1 0)2. |1 -q3 i6 72.!

Customer Name : _____

Confidential

Confidential

Package Dimension

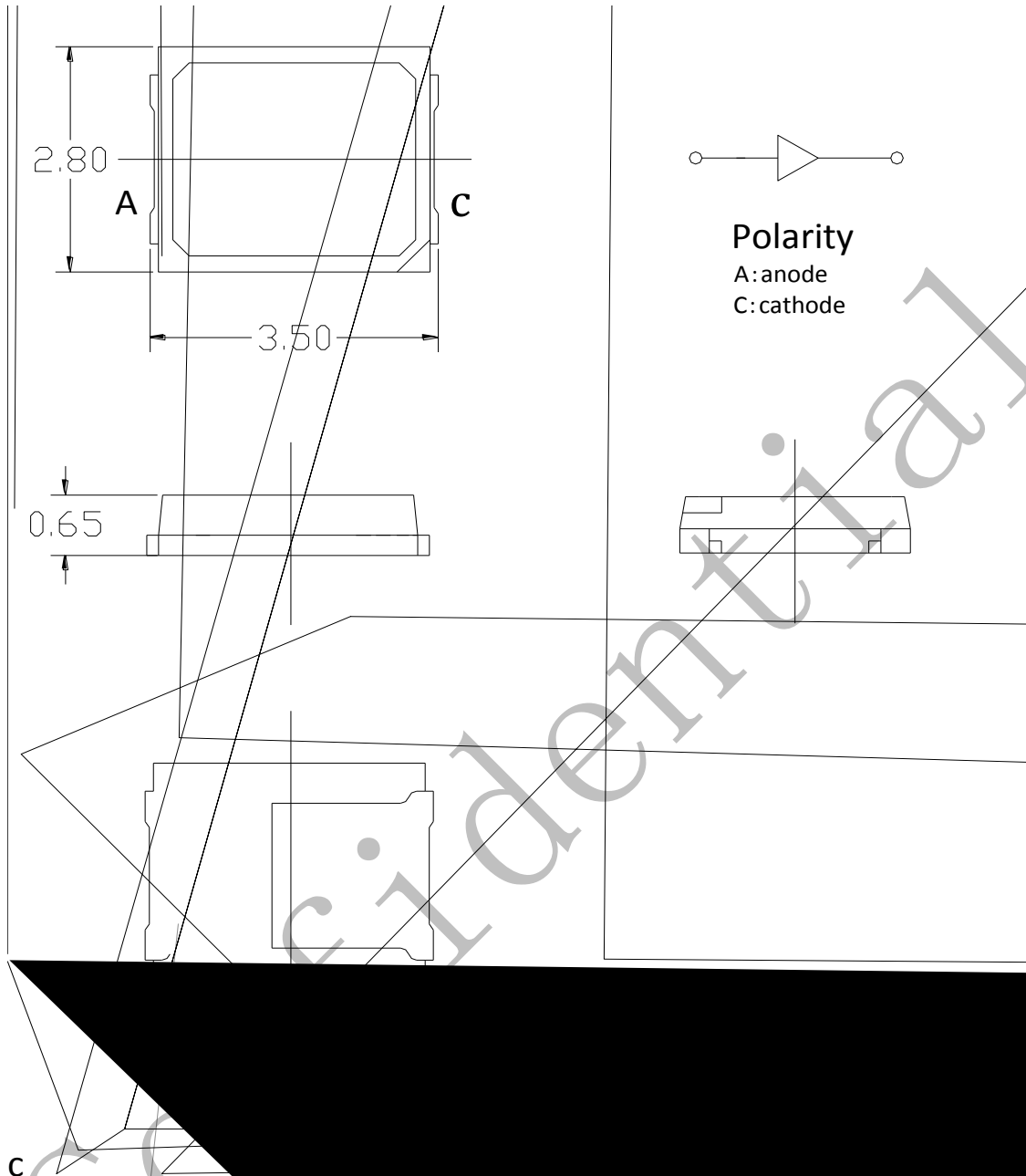

1.All dimensions units are mm. ()

2.All dimensions tolerances are ± 0.2 mm unless otherwise noted. (± 0.2)

Electrical / Optical Characteristics at Ts=25°C

Item	Code	Symbol	Test Condition	Value			Unit
				Min.	Max.	Typ.	
Forward Voltage	Rank G1	Vf	IF=150mA	2.8	2.9	/	V
	Rank G2			2.9	3.0		V
	Rank H1			3.0	3.1		V
	Rank H2			3.1	3.2		V
	Rank I1			3.2	3.3		V
	Rank I2			3.3	3.4		V
RF-W30HI35DS-FH-J Luminous flux	Rank TFA	∅	IF=150mA	65	70	67	lm
	Rank TGA			70	75		lm
	Rank THA			75	80		lm
RF-W35HI35DS-FH-J Luminous flux	Rank TFA	∅	IF=150mA	65	70	70	lm
	Rank TGA			70	75		lm
	Rank THA			75	80		lm
RF-W40HI35DS-FH-J Luminous flux	Rank TFA	∅	IF=150mA	65	70	74	lm
	Rank TGA			70	75		lm
	Rank THA			75	80		lm
RF-W50HI35DS-FH-J Luminous flux	Rank TFA	∅	IF=150mA	65	70	74	lm
	Rank TGA			70	75		lm
	Rank THA			75	80		lm
RF-W57HI35DS-FH-J Luminous flux	Rank TGA	∅	IF=150mA	70	75		lm
	Rank TFA			65	70		lm

Confidential

Absolute Maximum Ratings at Ts=25°C

Parameter	Symbol	Rating	Units
Power Dissipation	Pd	612	mW
Forward Current 号	IF	180	mA
Peak Forward Current	IFP	240	mA
Reverse Voltage 号	VR	5	V
Electrostatic Discharge(HBM)	ESD	2000	V
Operating Temperature	Topr	-40 ~ +85	
Storage Temperature	Tstg	-40 ~ +100	
Junction Temperature	Tj	115	

Note:

- 1.1/10 Duty cycle, pulse width 10ms. 10ms, 1/10.
- 2.The above forward voltage measurement allowance tolerance is 0.1V. 0.1V.
- 3.The above color coordinates measurement allowance tolerance is 0.003. 0.003.
4. The above luminous flux measurement allowance tolerance $\pm 10\%$. $\pm 10\%$.
- 5.Care is to be taken that power dissipation does not exceed the absolute maximum rating of the product.
- 6.When the LEDs are in operation the maximum current should be decided after measuring the package temperature, junction temperature should not exceed the maximum rate. LED

Confidential

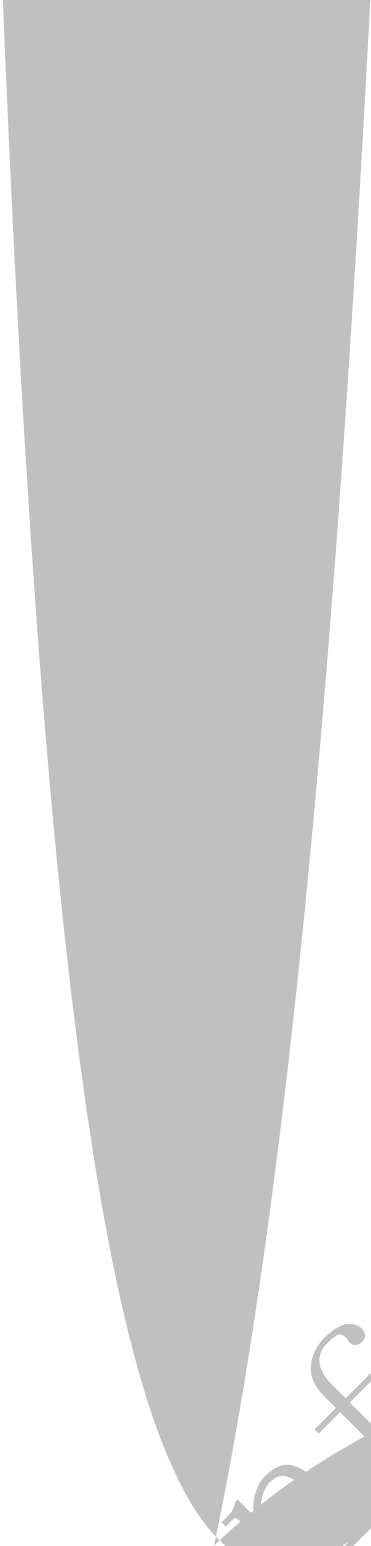

CONFIDENTIAL



Typical Optical Characteristics Curves

Fig.1-Forward Voltage Vs. Forward Current

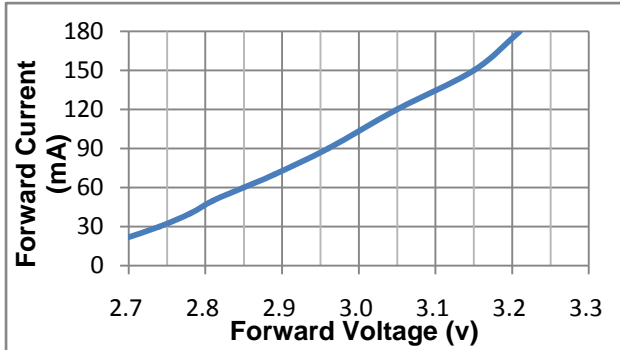

Fig.2-Forward Current Vs. Relative Intensity

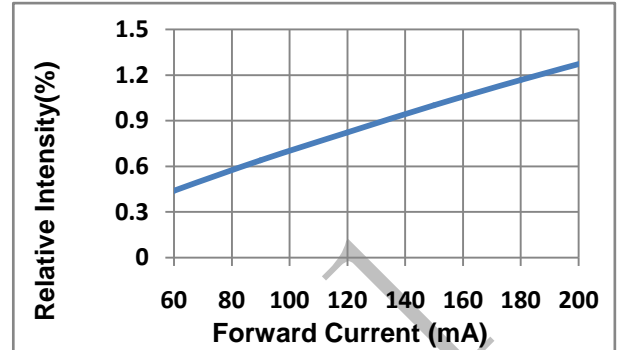

Fig.3-Ambient Temperature Vs. Relative Intensity

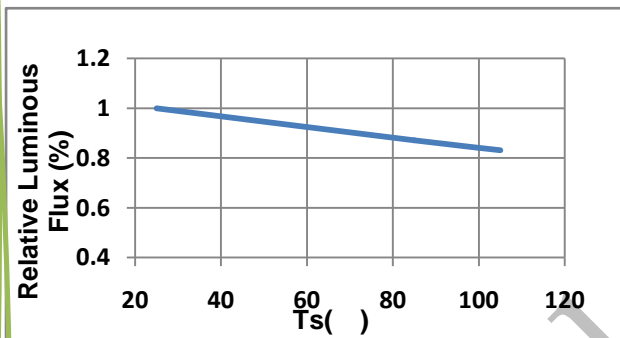

Fig.4-Ambient Temperature Vs. Forward Current

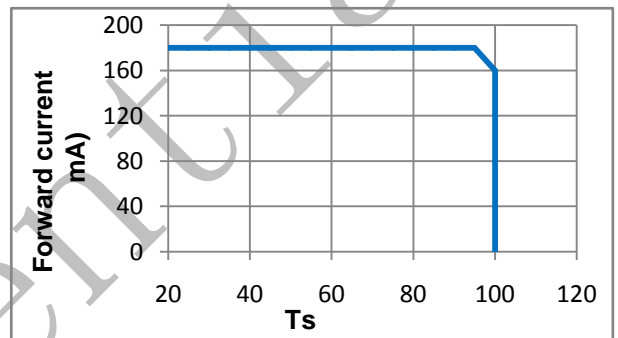

Fig.5-Forward Voltage Vs. Ambient Temperature

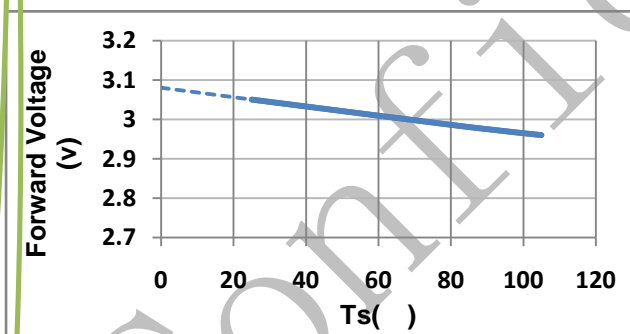

Fig.6-Radiation diagram

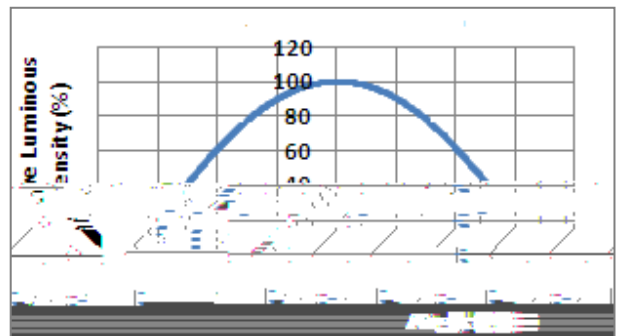
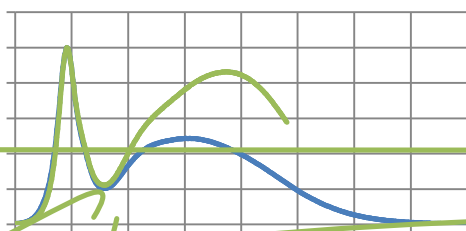

Fig.7- Spectrum Distribution



Note:

All the parameters and standards in the specification are based on Refond standard test platform.

Co

■ Label Form Specification

PART NO.	
SPEC NO.	
LOT NO.	

BIN CODE	
	XY
V	
F	
	QTY:
	DATE:

PART NO.	Part Number
SPEC	Spec Number
LOT NO.	Lot Number
BIN CODE	Bin Code
	Luminous flux
X/Y	Chromaticity Bin
VF	Forward Voltage
QTY	Packing Quantity
DATE	Made Date

■ Moisture Resistant Packing Process

■ Cardboard Box

Confidential

Confidential

SMT Reflow Soldering Instructions SMT

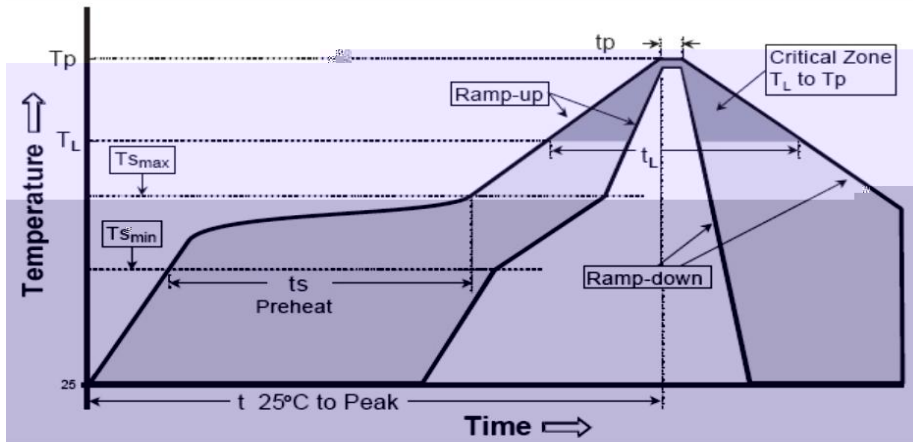

T _{Smax}	T _p	3 ° C/
(T _{Smin})		150 ° C
(T _{Smax})		200 ° C
t _{Smin}	t _{Smax}	60 - 120
(T _L)		217 ° C
(t _L)		60
/	(T _p)	260 ° C
:	t _p	10
(t _p)	5 ° C	30
		6 ° C/
25 ° C		8

1.Reflow soldering should not be done more than two times. In the case of more than 24 hours passed soldering after first, LEDs will be damaged. 上 上 24 LED

2.When soldering , do not put stress on the LEDs during heating

■ Soldering Iron

1.When hand soldering, keep the temperature of iron below less 300 less than 3 seconds
300 3

2.The hand solder should be done only one time.

■ Repairing

Repair should not be done after the LEDs have been soldered. When repairing is unavoidable, a double-head soldering iron should be used (as below figure). It should be confirmed in advance whether the characteristics of LEDs will or will not be damaged by repairing. LED

LED

■ Cautions

1.The encapsulated material of the LEDs is silicone. Therefore the LEDs have a soft surface on the top of package. The pressure to the top surface will be influence to the reliability of the LEDs. Precautions should be taken to avoid the strong pressure on the encapsulated part. So when use the picking up nozzle, the pressure on the silicone resin should be proper. LED LED

2. Do not apply mechanical force or excess vibration during the cooling process to normal temperature after soldering. Do not rapidly cool device after soldering.

前

Co

Confide

Confidential