

# SPECIFICATION

RF-G9CW\*\*1J-TD

Mass Product



## 1. Description

### 1.1

TheWhiteLED whichwas fabricatedusing abluechipandthephosphor

### 1.4 Package Dimension

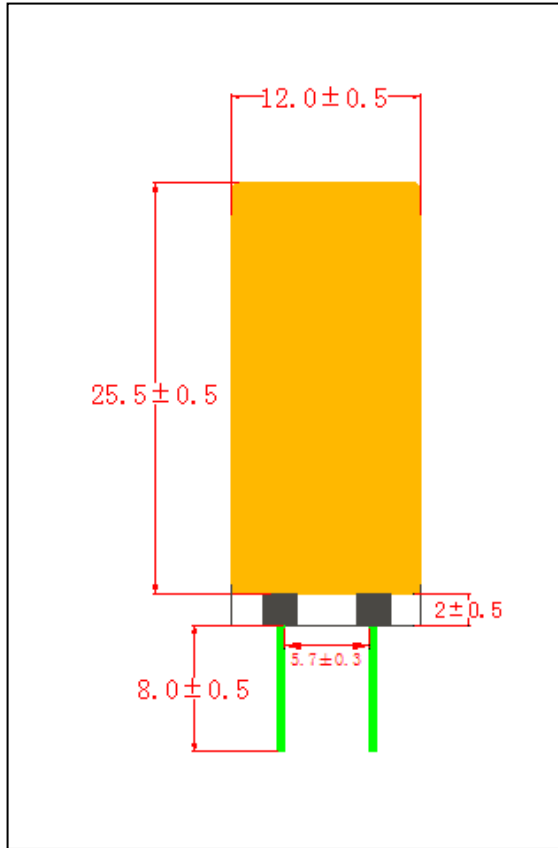

Front View



Reversed Drawing

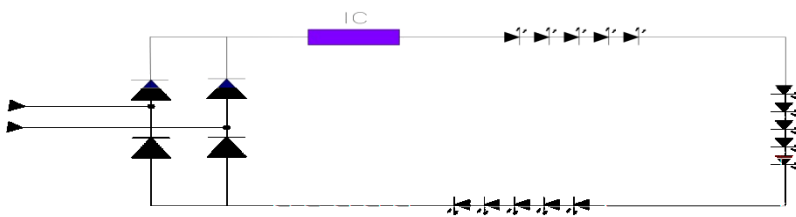



**ATTENTION**  
OBSERVE PRECAUTIONS  
FOR HANDLING  
ELECTROSTATIC  
SENSITIVE DEVICES

Notes

All dimensions units are millimeters.

All dimensions tolerances are 0.5mm unless otherwise noted.

## 1.5 Product Parameters

Table 1-1 Electrical / Optical Characteristics at Ts=25°C

Item	Symbol	Test Condition	Value			Unit
			Min.	Typ	Max.	
Forward Voltage	AC	AC230v	225	---	235	V
Luminous Flux		AC230v	300	---	500	lm
Viewing Angle		AC230v	---	---	360	deg
Color Rendering Index	Ra	AC230v	80	---	---	/
Color Rendering Index	R9	AC230v	0	---	---	/
Power	P	AC230v	2.8	3.1	3.4	W

Table 1-2 Absolute Maximum Ratings at Ts=25°C

Parameter	Symbol	Rating	Units
Power Dissipation	P <sub>D</sub>	3.73	W
Frequency (Hz) 额定频率	Hz	60	Hz
Electrostatic Discharge (HBM)	E <sub>SD</sub>	2000	V
Operating Temperature	T <sub>OPR</sub>	-40 ~ +85	
Storage Temperature	T <sub>OPR</sub>	-40 ~ +85	
Junction Temperature	T <sub>J</sub>	125	

### Notes

- 1/10 Duty cycle, 0.1ms pulse width.

2. The above forward voltage measurement allowance tolerance is  $\pm 1V$ .  $\pm 1V$
3. The above color coordinates measurement allowance tolerance is 0.005.
4. The above luminous intensity measurement allowance tolerance  $\pm 10\%$ .
5. Care is to be taken that power dissipation does not exceed the absolute maximum rating of the product.
6. All measurements were made under the standardized environment of Us.
7. When the LEDs are in operation the maximum current should be decided after measuring the package temperature , junction temperature should not exceed the maximum rate
8. ESD yield is over 90% at 2000V ESD (HBM). ESD protection during products handing is needed.
9. The filament is a non-spectroscopic product, and the commitment baTDh meets the optical/electrical parameter range of more than 90 %.

## 1.5 Bin Range Of Luminous Flux and The Chromaticity Diagram (IF=15 2mA)

### BIN (AC=230V)

Table 1-3

RF-G9CW2C1J-TD 2200K	Rank430		RF-G9CW2H1J-TD 2400K	Rank430	
	400	460		400	460
RF-G9CW2R1J-TD 2700K	Rank480		RF-G9CW2K1J-TD 2700K	Rank480	
	450	510		450	510
RF-G9CW3E1J-TD 3000K	Rank490		RF-G9CW3S1J-TD 3000K	Rank490	
	460	520		460	520
RF-G9CW4E1J-TD 4000K	Rank500		RF-G9CW4S1J-TD 4000K	Rank500	
	470	530		470	530

RF-G9CW5E1J-TD 5000K	Rank500		RF-G9CW5S1J-TD 5000K	Rank500	
	470	530		470	530
RF-G9CW6E1J-TD 6500K	Rank500		RF-G9CW6S1J-TD 6500K	Rank500	
	470	530		470	530

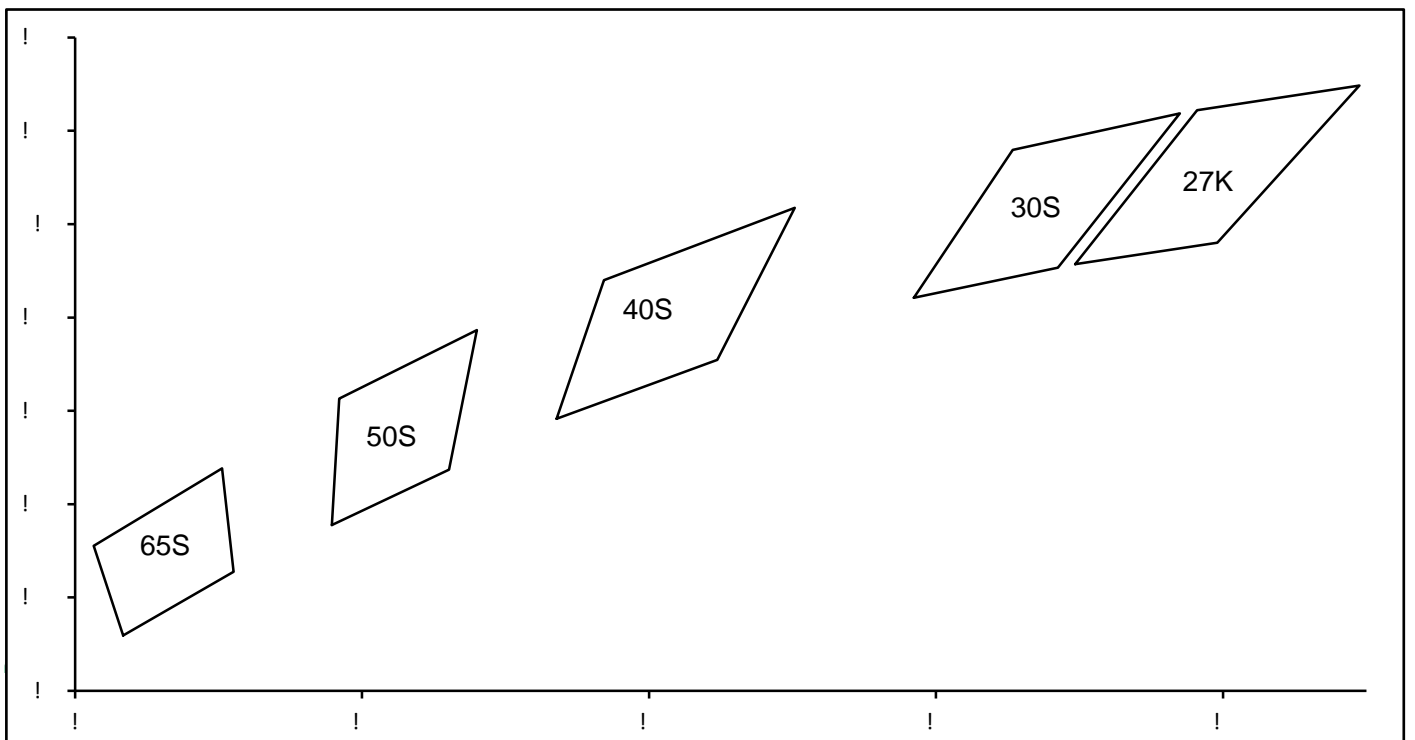
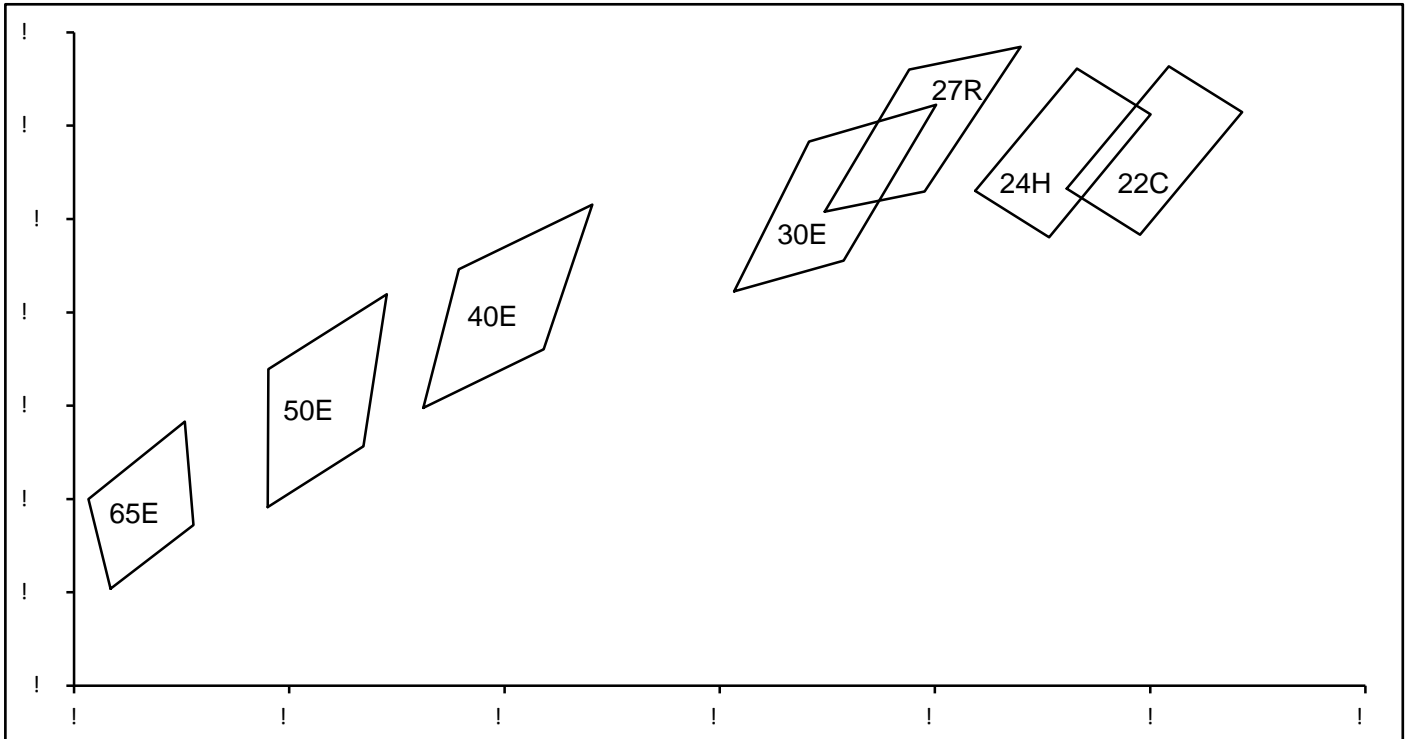

Fig 1-3 The C.I.E Chromaticity Diagram CIE

Table 1-4

BIN CODE	CIE-X1	CIE-Y1	CIE-X2	CIE-Y2	CIE-X3	CIE-Y3	CIE-X4	CIE-Y4
22C	0.4845	0.4065	0.5035	0.4327	0.5171	0.4229	0.4981	0.3966
24H	0.4675	0.4060	0.4864	0.4322	0.5001	0.4224	0.4812	0.3961
27R	0.4395	0.4016	0.4552	0.4320	0.4759	0.4369	0.4581	0.4059
30E	0.4227	0.3845	0.4366	0.4166	0.4602	0.4245	0.4430	0.3911
40E	0.3649	0.3595	0.3715	0.3892	0.3963	0.4031	0.3873	0.3721
50E	0.3360	0.3383	0.3361	0.3678	0.3581	0.3839	0.3538	0.3513
65E	0.3068	0.3208	0.3027	0.3400	0.3206	0.3566	0.3222	0.3344
27K	0.4394	0.3914	0.4564	0.4244	0.4790	0.4297	0.4592	0.3960
30S	0.4169	0.3842	0.4307	0.4159	0.4540	0.4237	0.4370	0.3907
40S	0.3671	0.3583	0.3737	0.3880	0.4003	0.4035	0.3895	0.3709
50S	0.3358	0.3355	0.3368	0.3626	0.3560	0.3773	0.3521	0.3474
65S	0.3067	0.3119	0.3026	0.3311	0.3205	0.3477	0.3221	0.3255

## 1.6 Typical optical characteristics curves

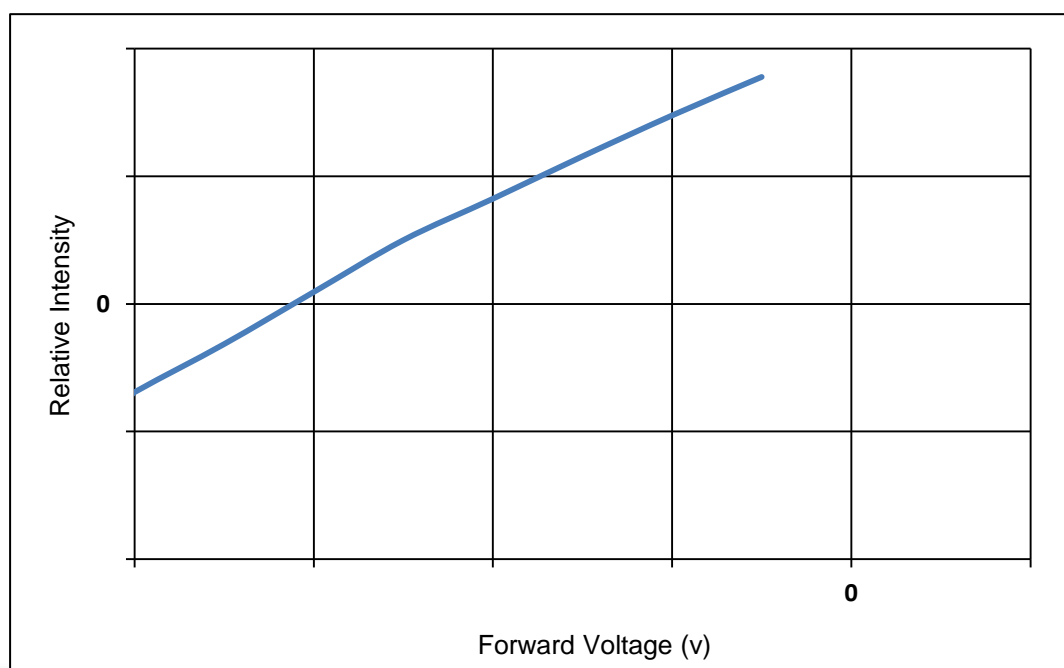



Fig 1-1 Forward Voltage Vs. Relative Intensity

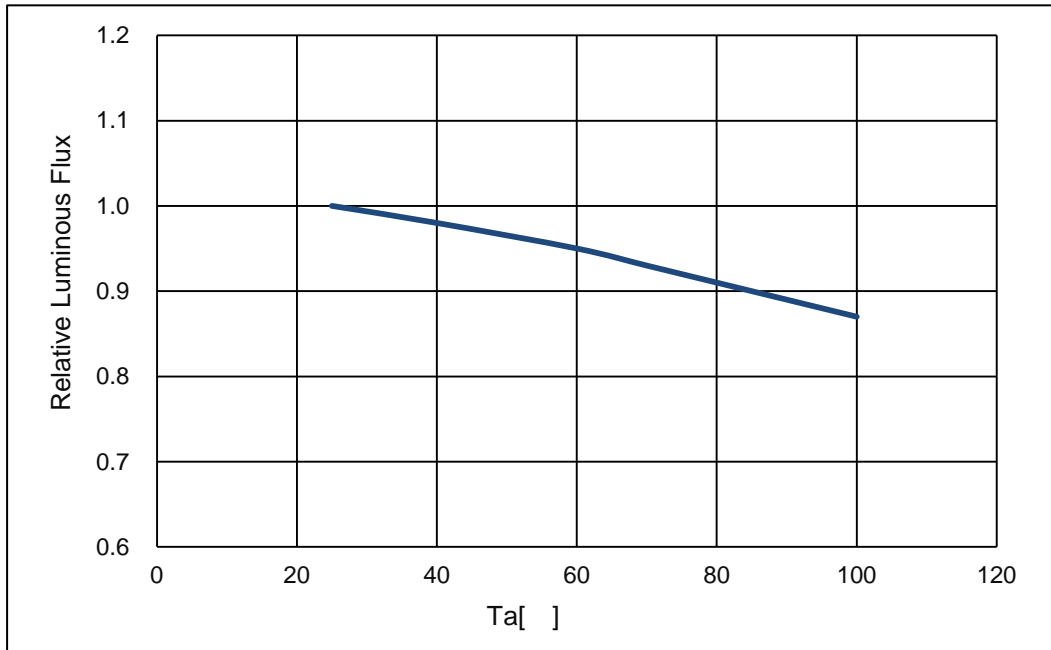

Fig 1-2 Ambient Temperature Vs. Relative Intensity

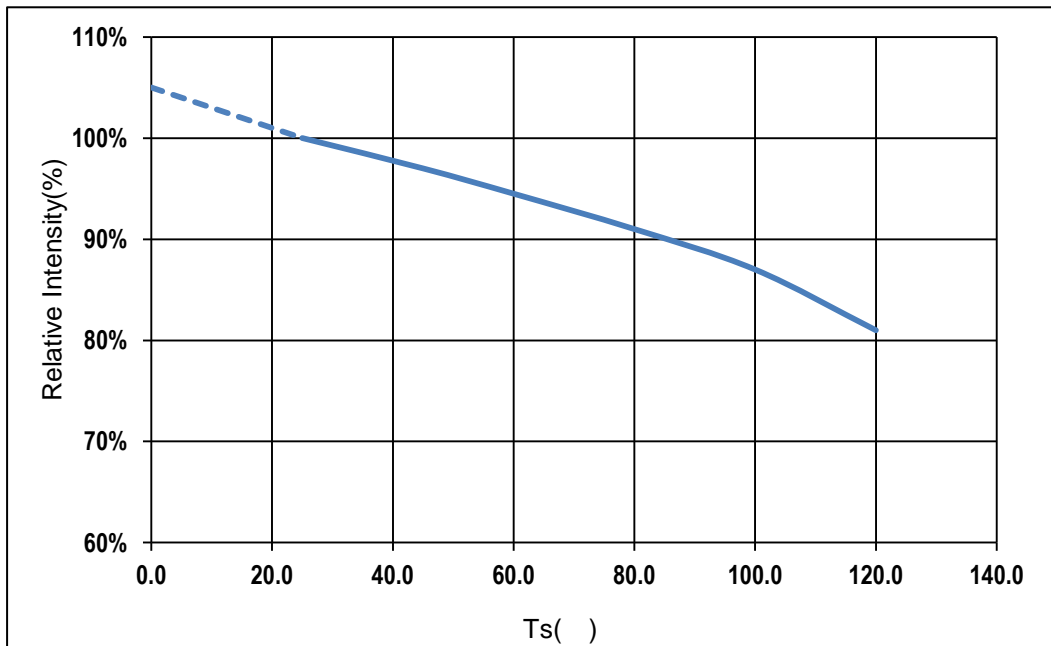

Fig 1-3 Central surface temperature Vs Relative Intensity

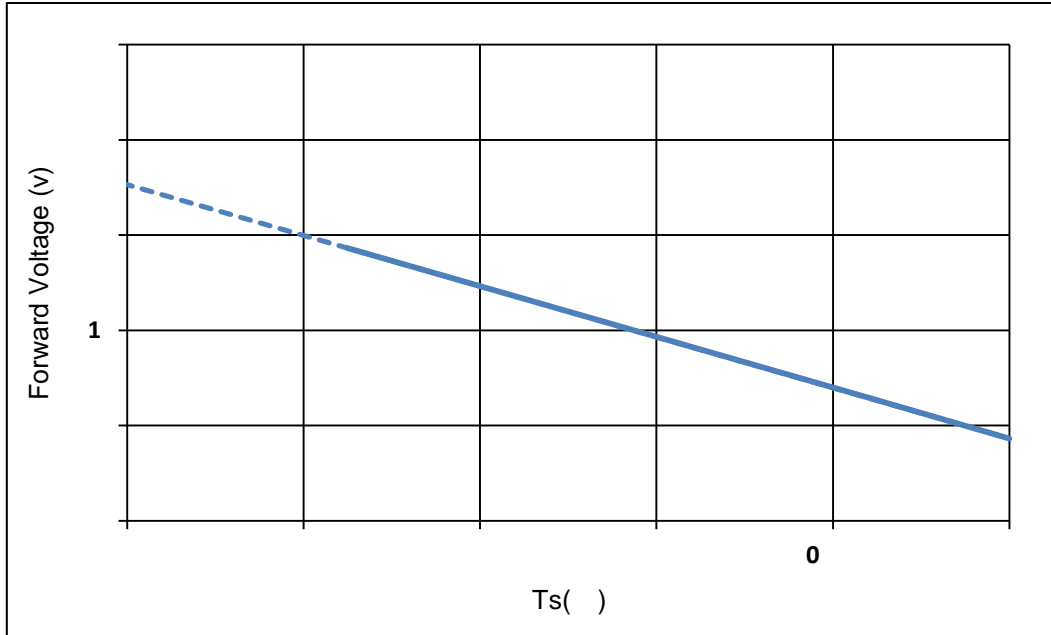

Fig 1-4 Forward Voltage Vs Central surface temperature

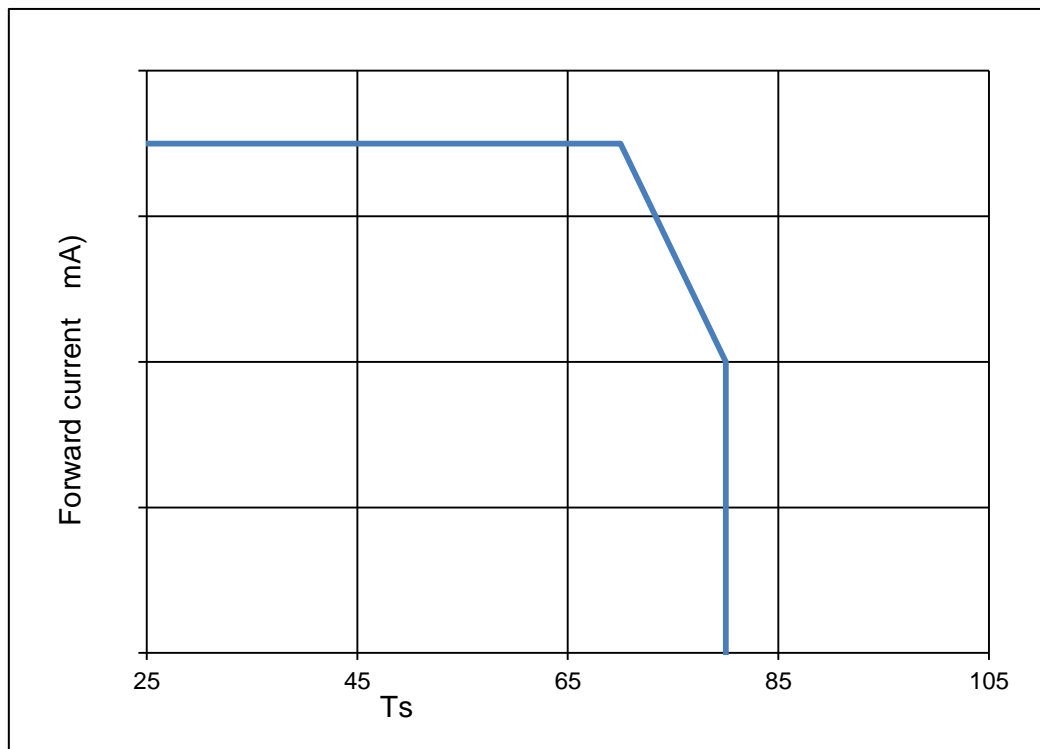

Fig 1-5 Central surface temperature VsForward Current

Fig 1-7 Chromaticity Coordinate Vs Central surface Temperature

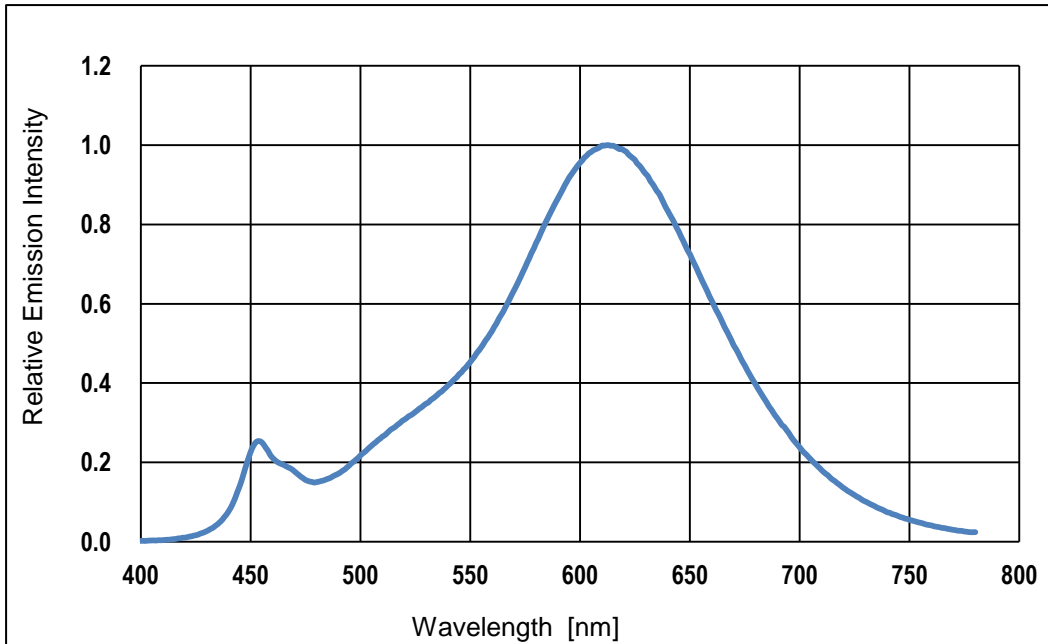

Fig 1-8 Spectrum Distribution

## 2. Packaging

### 2.1 Packaging Specification

Package: 50pcs/box. a

#### 2.1.1 Suction box Dimension

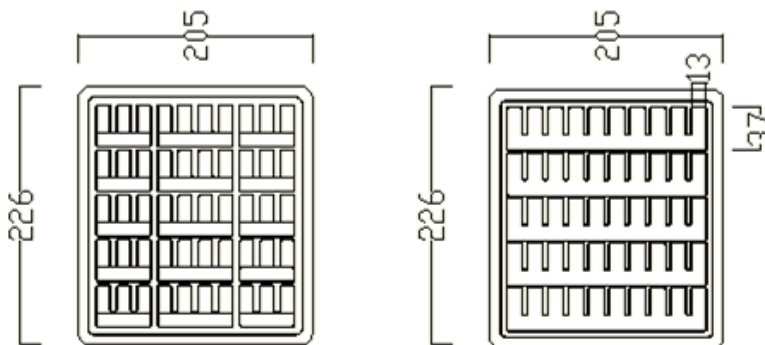

Fig.2-1 Suction box Dimension

Notes

The tolerances unless mentioned  $\pm 0.1\text{mm}$ . Unit : mm 注：未注公差为 $\pm 0.1$ 毫米 尺寸单位：毫米

2.1.2 Label Form Specification

Table 2-2 label

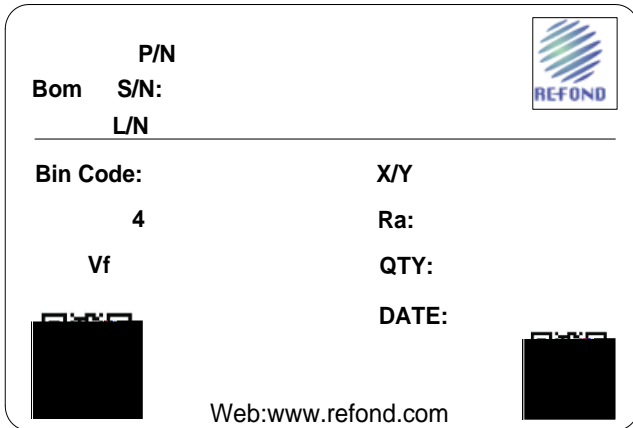

P/ N	Part Number
S/N	Spec Number
L/N	Lot Number
Bin Code	Bin Code
	Luminous flux
X/Y	Chromaticity Bin
V <sub>F</sub>	Forward Voltage
R <sub>a</sub>	Color Rendering Index
QTY	Packing Quantity
DATE	Made Date

Fig 2-2 label

2.2 Moisture Resistant Packing

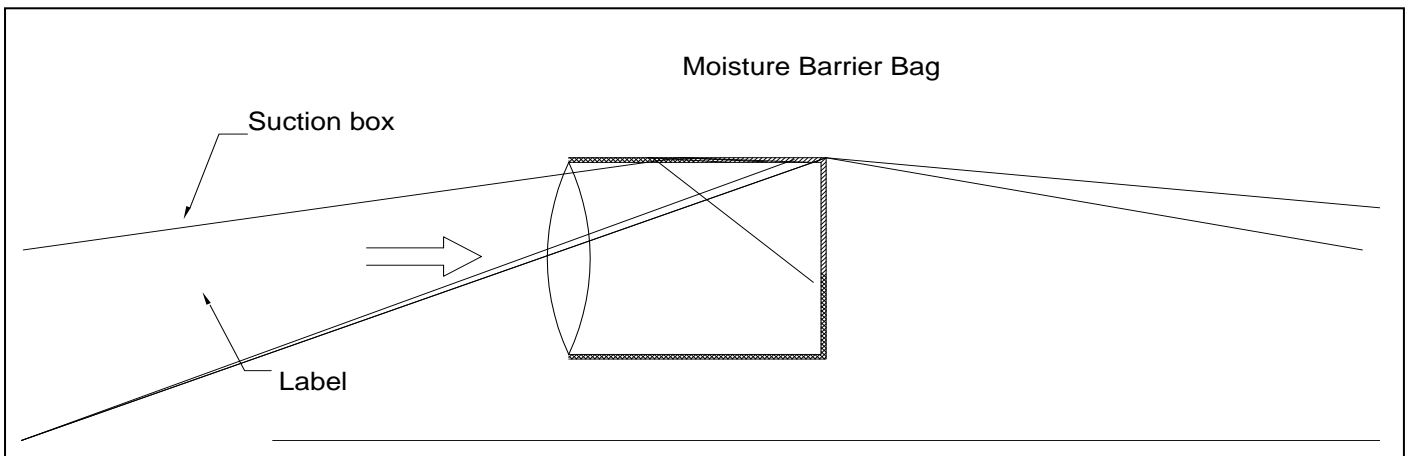

Fig.2-3Moisture Resistant Packing

## 2.3 Cardboard Box

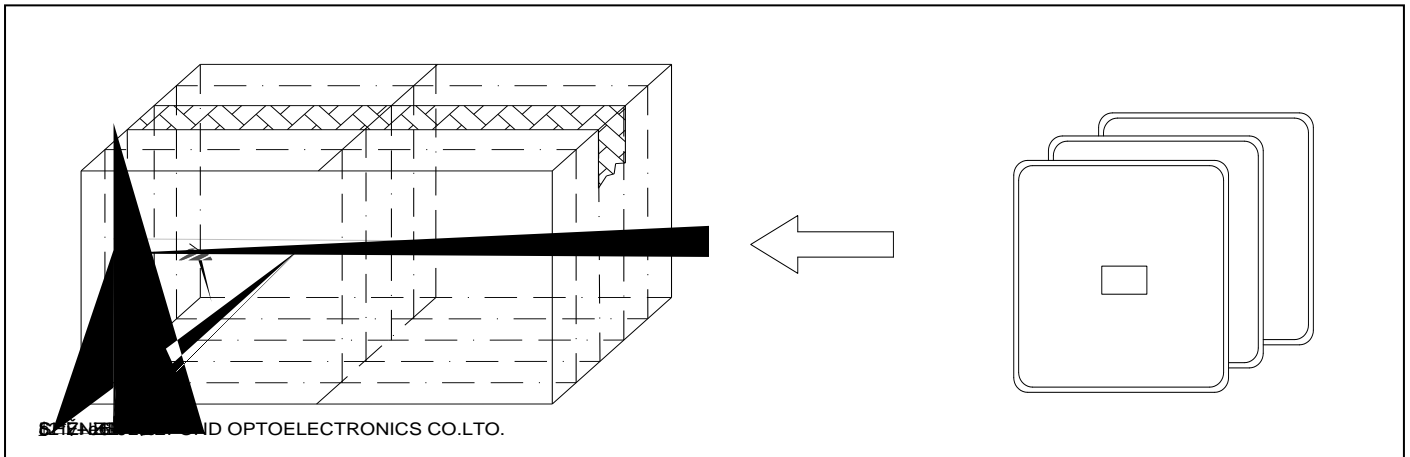

Fig.2-4Cardboard Box

## 2.4 Reliability Test Items And Conditions

Table 2-3 Reliability Test Items And Conditions

TestItems	Ref.Standard	Test Condition	Time	Quantity	Ac/Re /
Thermal Shock	JEITAED-4701 300307	-40 15min 10s 100 15min	1000cycle	10pcs.	0/1
SwiTDhing Test	/	25 , On 2.5min Off 2.5min	2500cycle	10pcs.	0/1

Life Test	JESD22-A108	Ta=25 AC=230v	1000hrs.	10pcs.	0/1
High Temperature High Humidity Life Test	JESD22-A101	60 / 90%RH AC=230v	500hrs.	10pcs.	0/1

## 2.5 Criteria For Judging Damage

Table 2-4 Criteria For Judging Damage

Test Items	Symbol	Test Condition	Criteria For Judgement	
			Min.	Max.
Power	W	AC=230v	L.S.L*)x0.90	U.S.L*)x1.1
Luminous Flux		AC=230v	L.S.L*)x0.7	-

### Notes

- 1.U.S.L: Upper standard level                      L.S.L: Lower standard level
- 2.The Reliability tests are based on Us existing test platform.
- 3.The technical information shown in the data sheets are limited to the typical characteristics and circuit examples of the referenced products. It does not constitute the warranting of industrial property nor the granting of any license.

## 3. Handling Precautions

### 3.1 Handling Precautions

(1) LED operating environment and sulfur element composition cannot be over 100PPM in the LED mating usage material. This is provided for informational purposes only and is not a warranty or endorsement. LED

(2) In order to prevent external material from getting into the inside of LED, which may cause the malfunction of LED, the single content of Bromine element is required to be less than 900PPM, the single content of Chlorine element is required to be less than 900PPM, the total content of Bromine element and Chlorine element in the external materials of the application products is required to be less than 1500PPM. This is provided for informational purposes only and is not a warranty or endorsement.

(3) VOCs (Volatile organic compounds) emitted from materials used in the construction of fixtures can penetrate silicone encapsulants of LEDs and discolor when exposed to heat and photonic energy. The result can be a significant loss of light output from the fixture. Knowledgeen-US.ed disco



Fig 4-1 Clip filament specification

(5) In designing a circuit, the current through each LED must not exceed the absolute maximum rating specified for each LED. In the meanwhile, resistors for protection should be applied, otherwise slight voltage shift will cause big current change, burn out may happen. The driving circuit must be designed to allow forward voltage only when it is ON or OFF. If the reverse voltage is applied to LED, migration can be generated resulting in LED damage.

(6) Thermal Design is paramount importance because heat generation may result in the Characteristics decline, such as brightness decreased, Color change and so on. Please consider the heat generation of the LEDs when making the system design. LED

(7) Compared to standard encapsulants, silicone is generally softer, and the surface is more likely to attract dust, requiring special care during processing. In cases where a minimal level of dirt and dust particles cannot be guaranteed, a suitable cleaning solution must be applied to the surface after the soldering of components. We suggest using isopropyl alcohol for cleaning. In case other solvents are used, it must be assured that these solvents do not dissolve the package or resin. Ultrasonic cleaning is not recommended. Ultrasonic cleaning may cause damage to the LED.

Table 4-1 Storage

Conditions		Temperature	Humidity	Time
Storage	Before Opening Aluminum Bag	30	75%	Within 1 Year From Date
	After Opening Aluminum Bag	30	60%	24hours 24
Baking		60 5	-	24hours 24

(8) If the moisture absorbent material ( silica gel ) has faded away or the LEDs have exceeded the storage time , baking treatment should be performed after unpacking and based on the following condition ( 65±5 ) °C for above 24 hours.

If the package is flatulence or damaged, please notify the sales staff to assist.

(9) Similar to most Solid state devices; LEDs are sensitive to Electro-Static Discharge (ESD) and Electrical Over Stress (EOS).

(10) Other points for attention, please refer to our relevant information.

