

.....

.....

.....

.....

.....

.....

.....

.....

.....



11

11

12

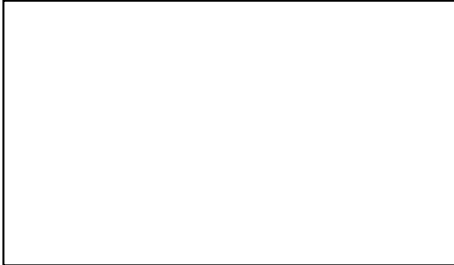
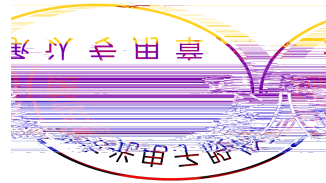

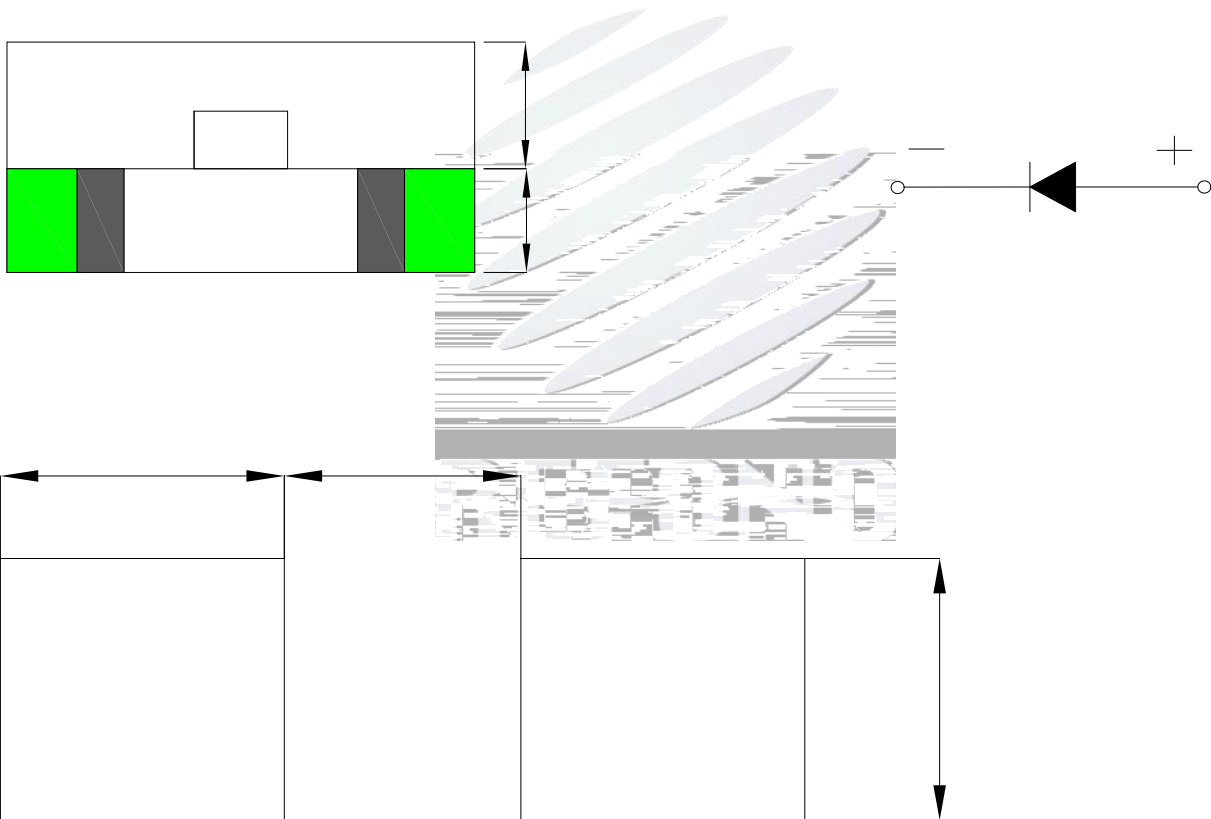
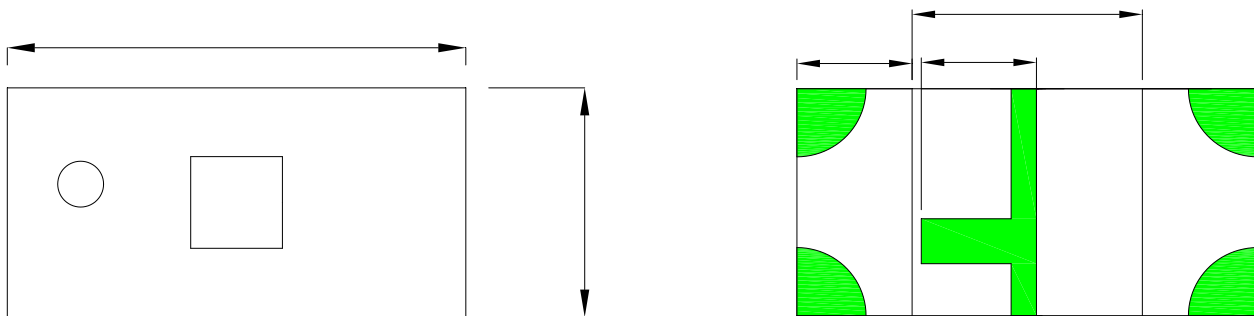

±



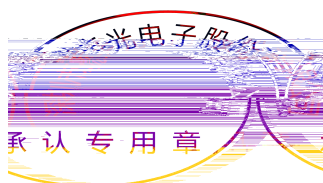
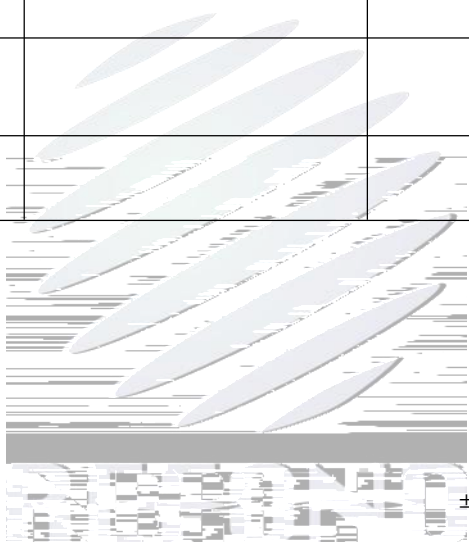

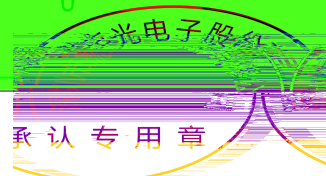
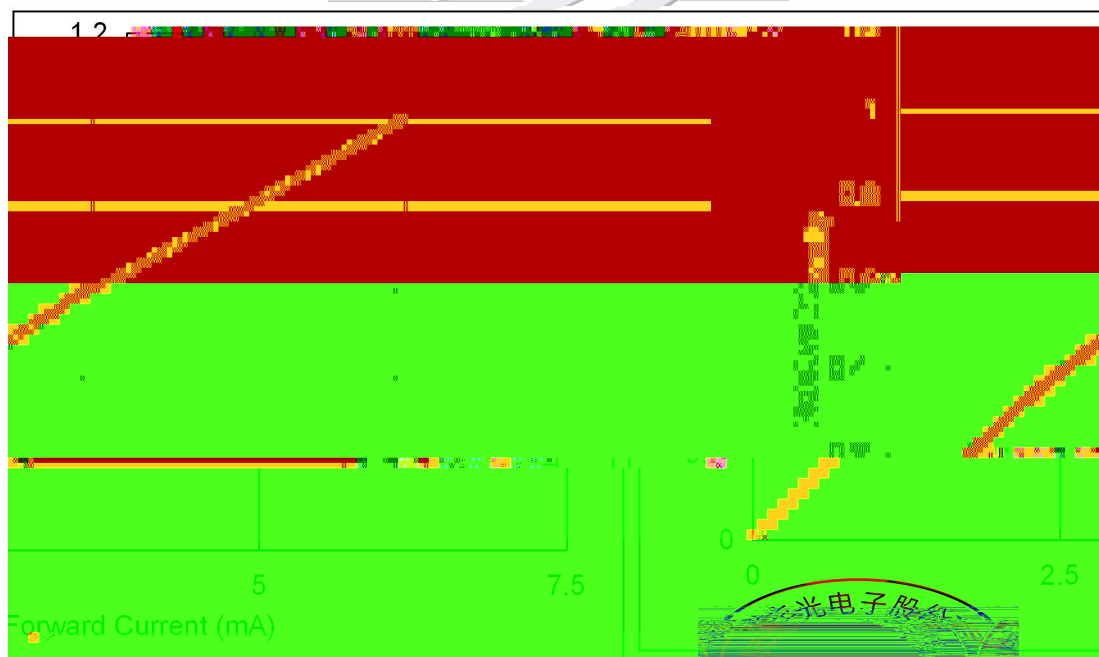
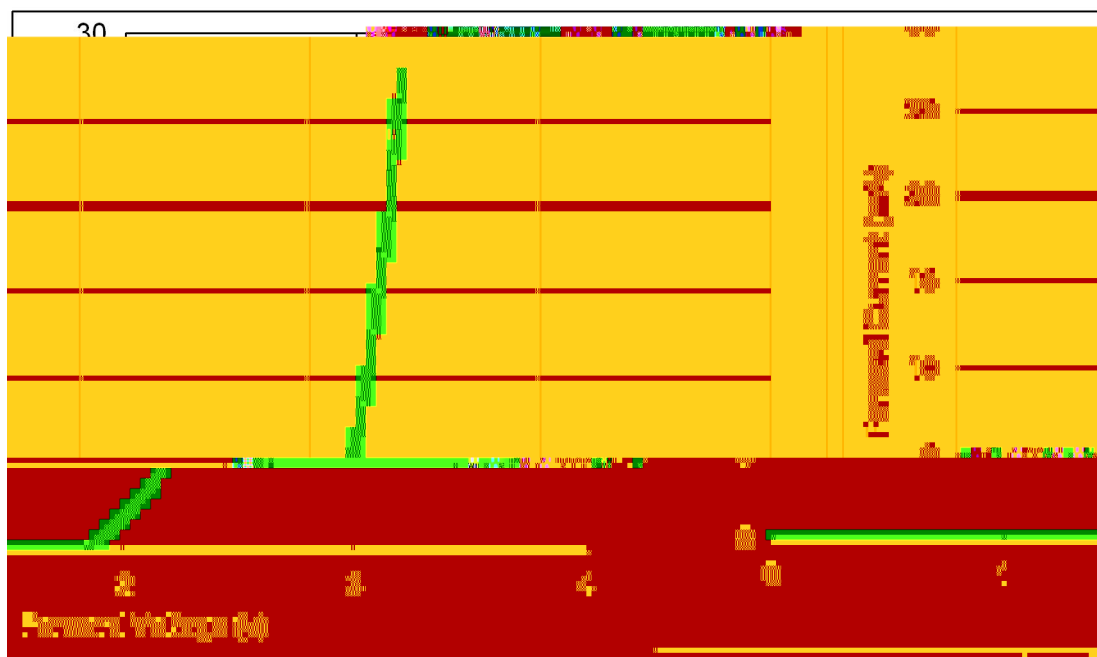

HPS



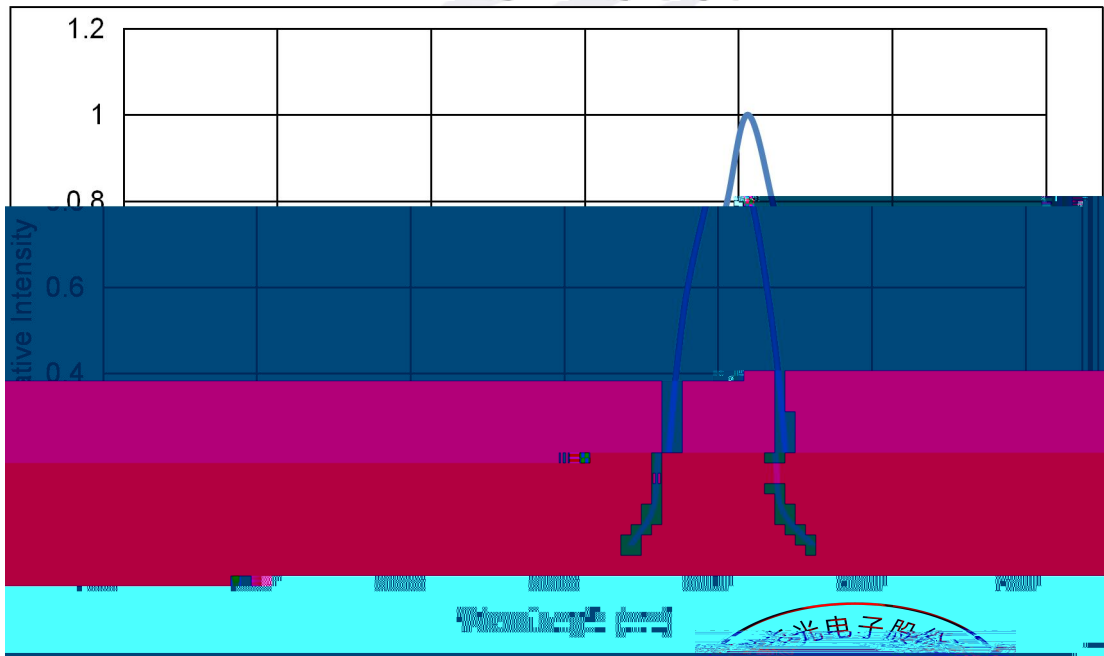
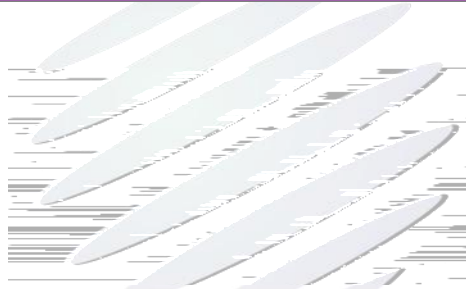
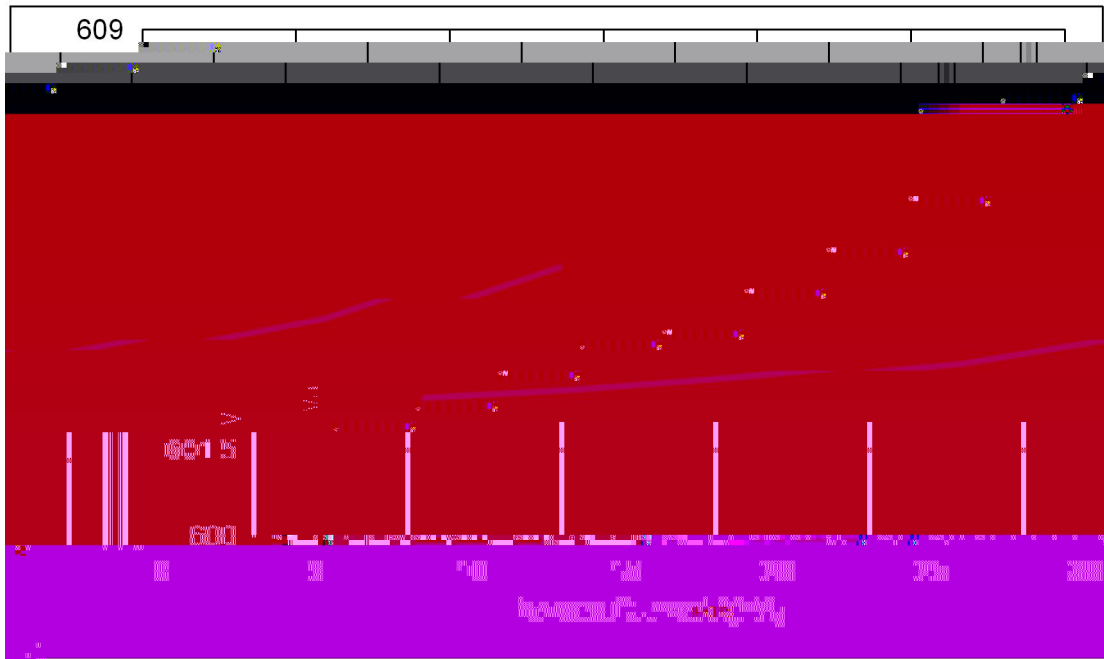

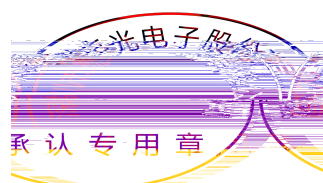
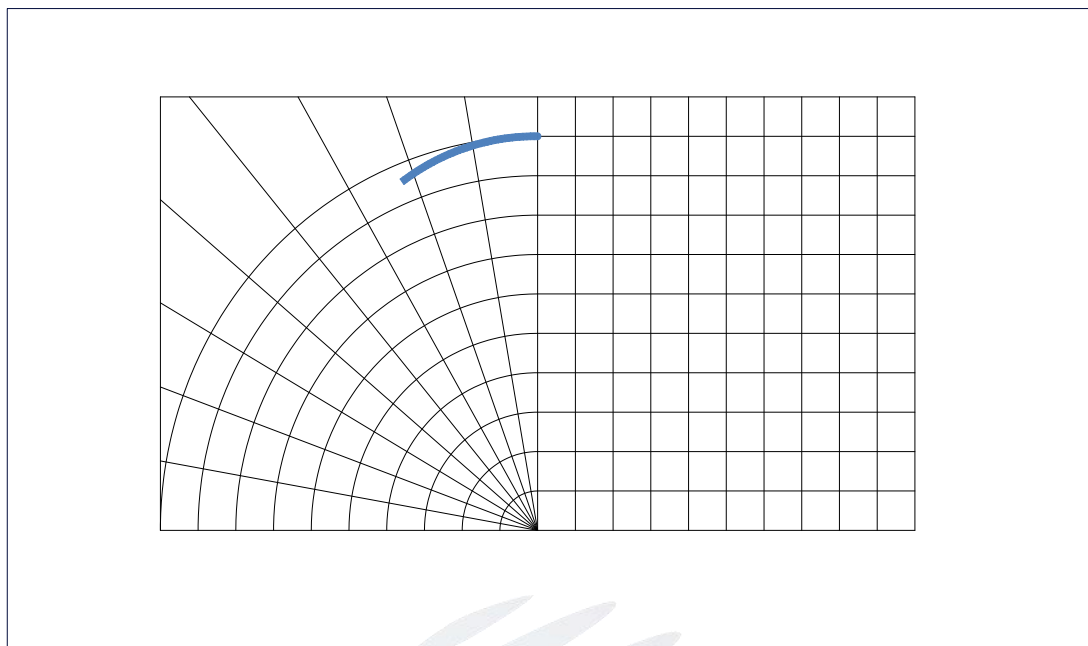

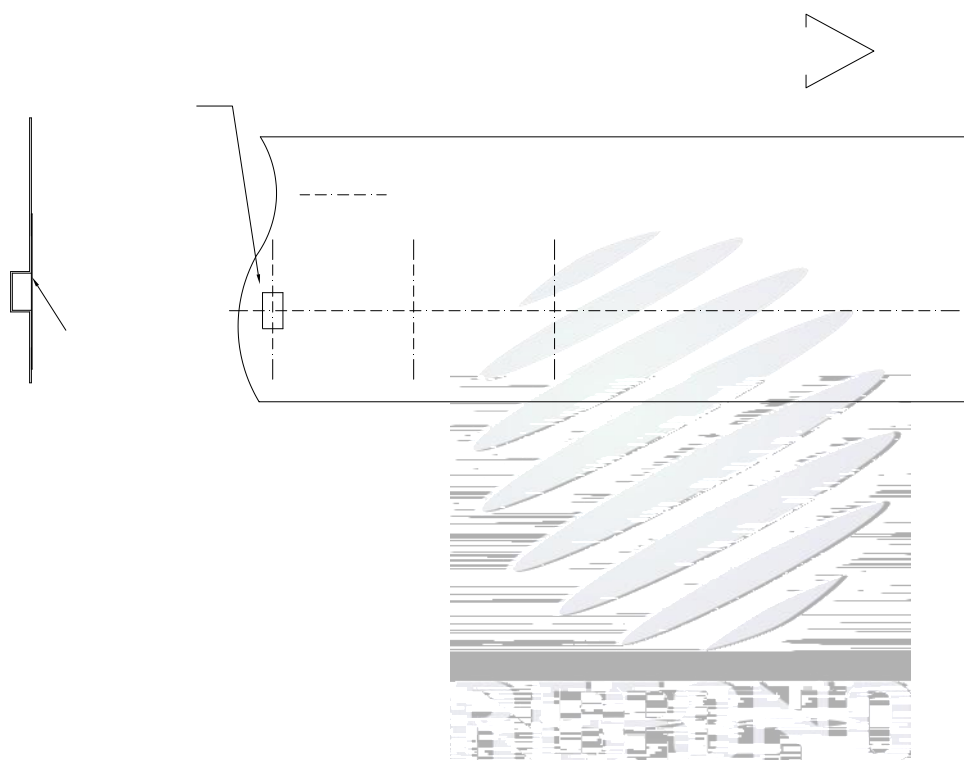



PART NO: .
 SPEC NO:
 LOT NO

BIN CODE:
 Φ: XY:
 VF: WLD:

QTY:
 DATE:



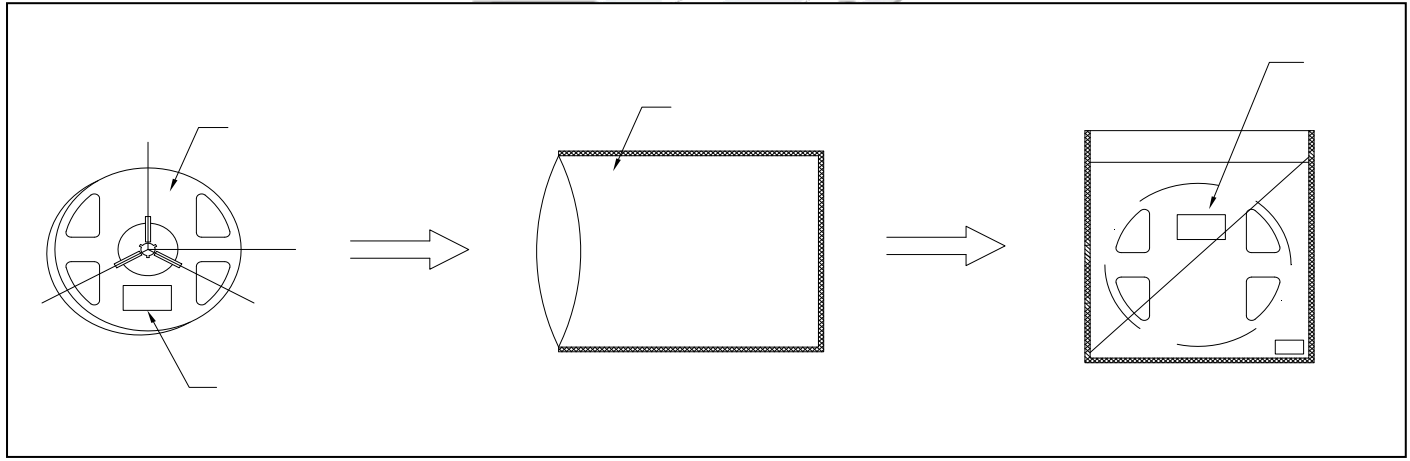

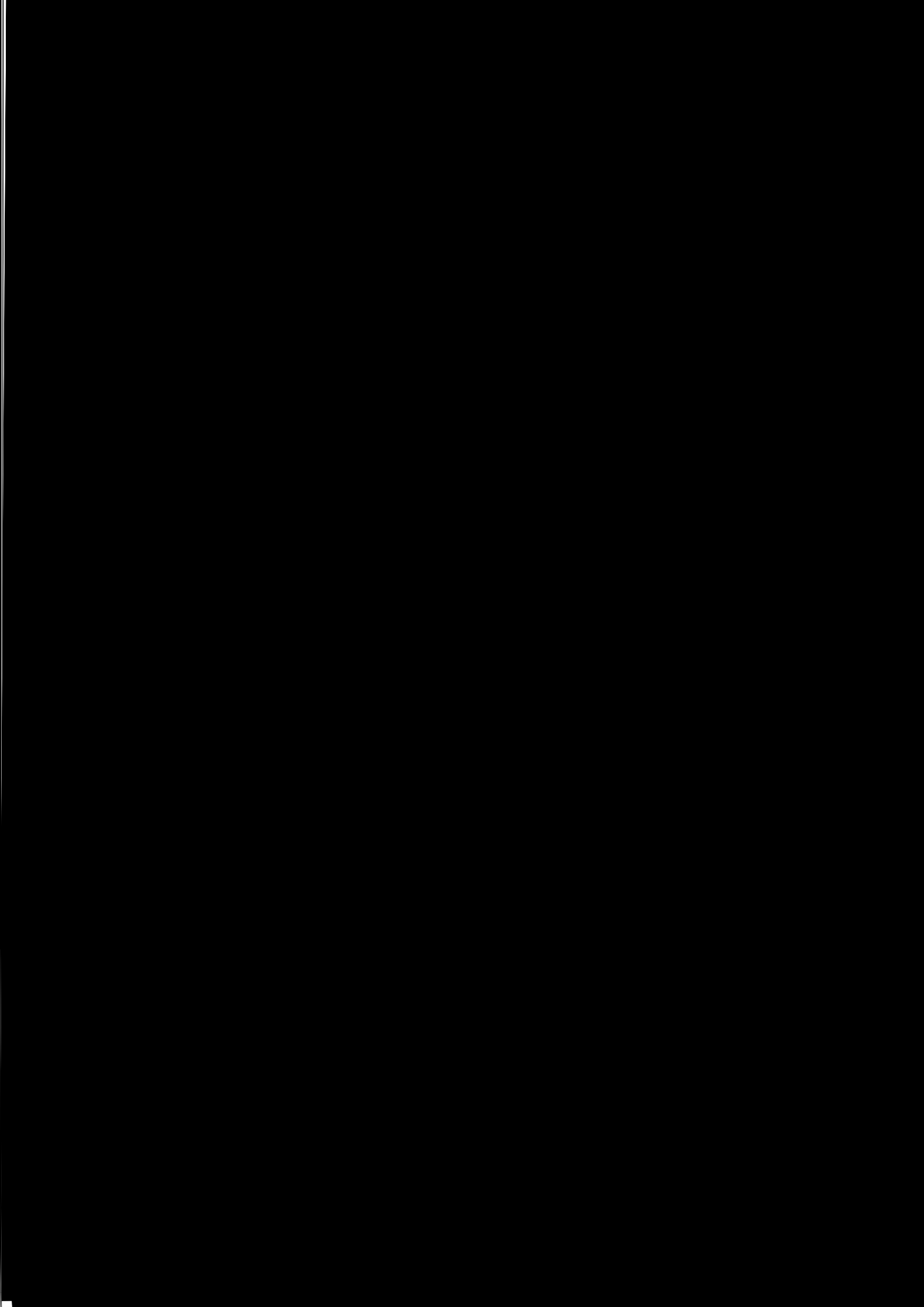



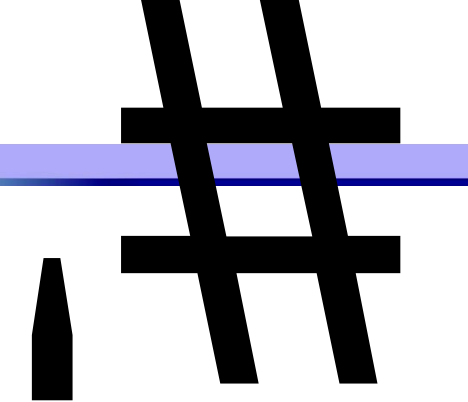

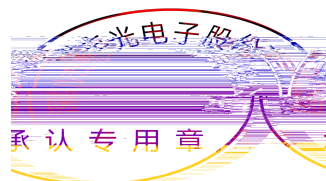



±



