

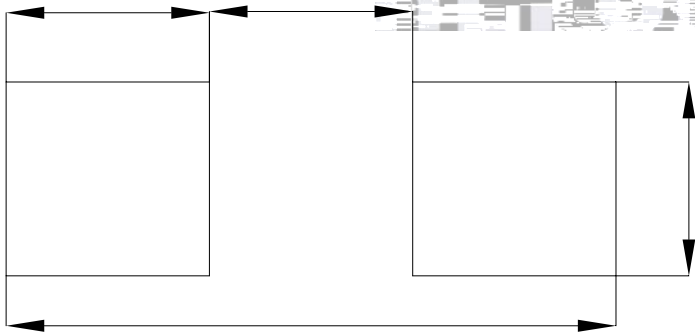

0

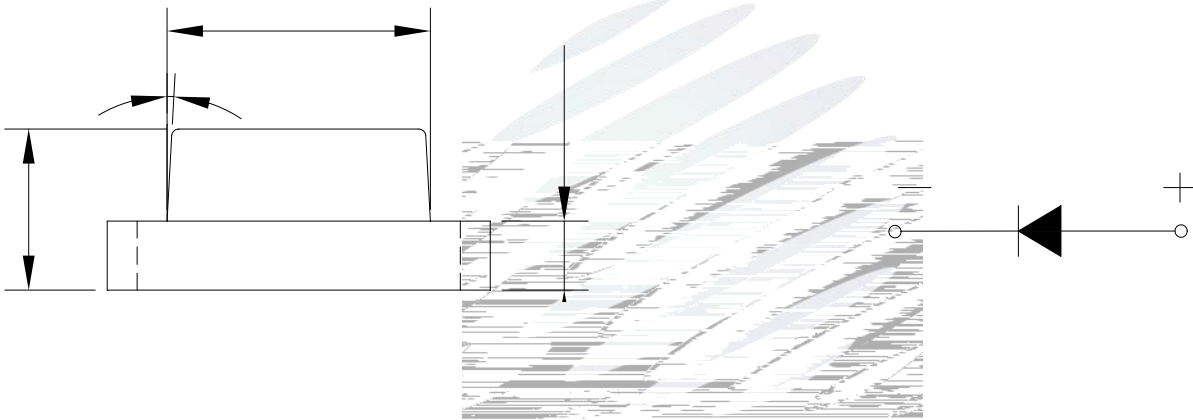

±

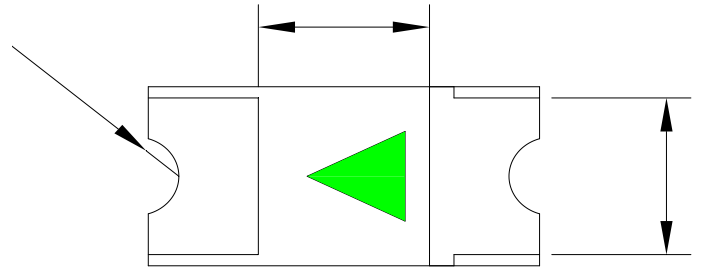
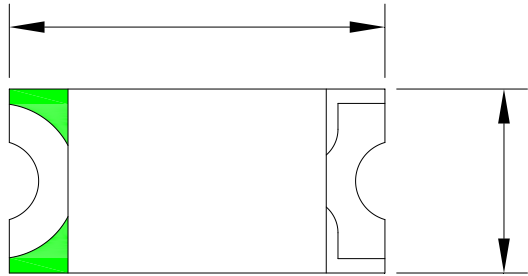
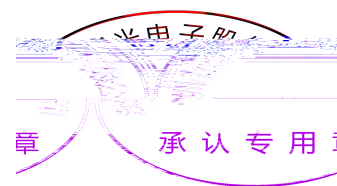

						μ

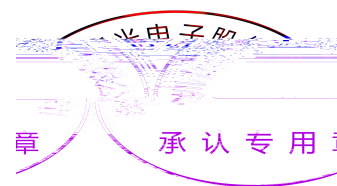

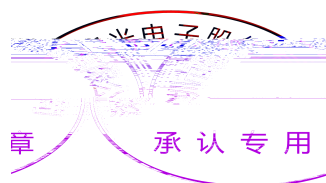
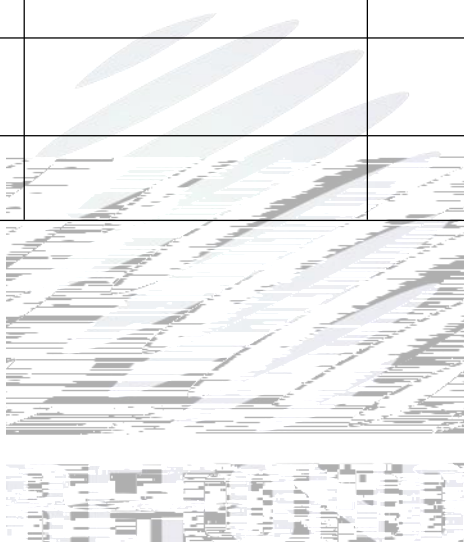

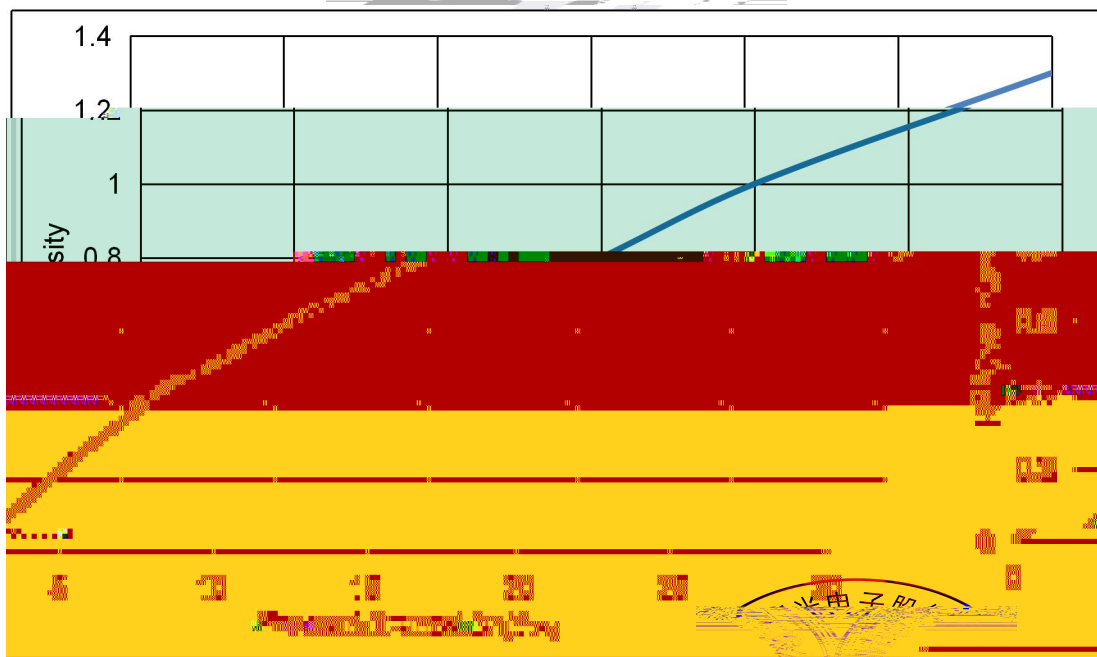
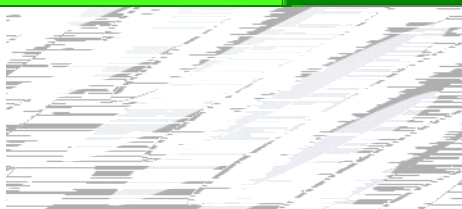
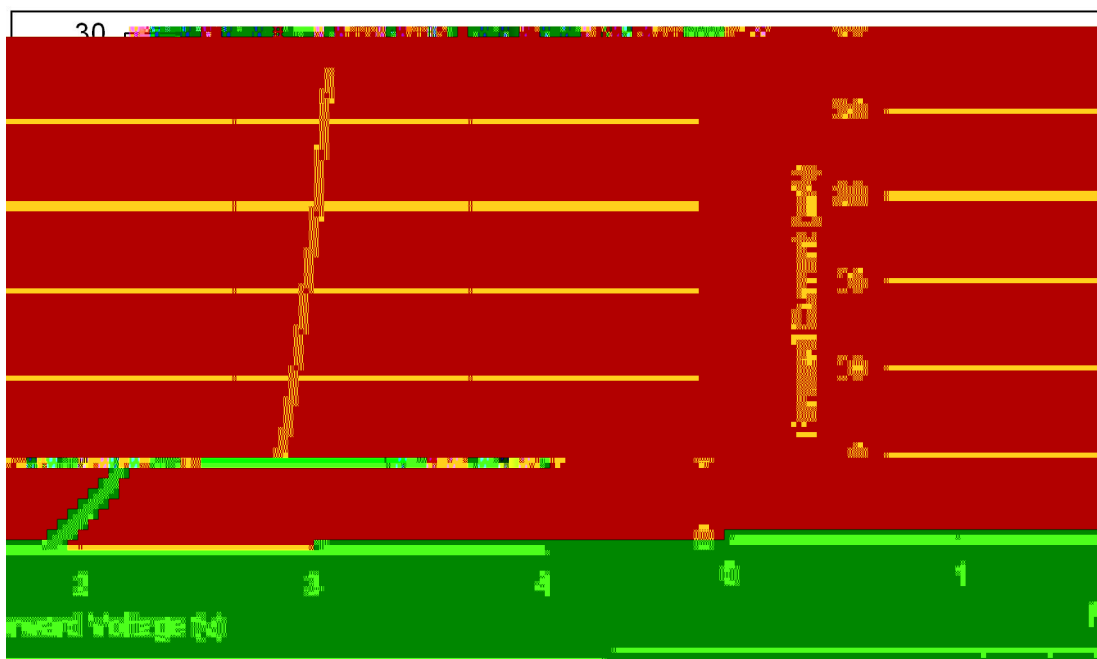

草 承认专用

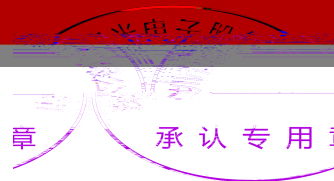
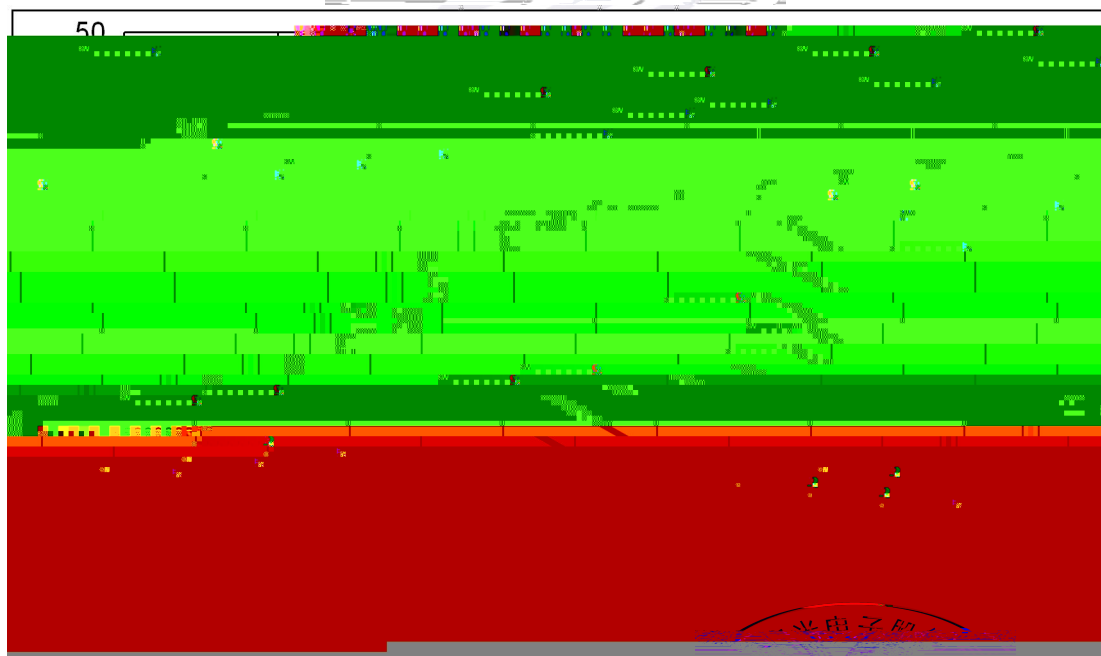
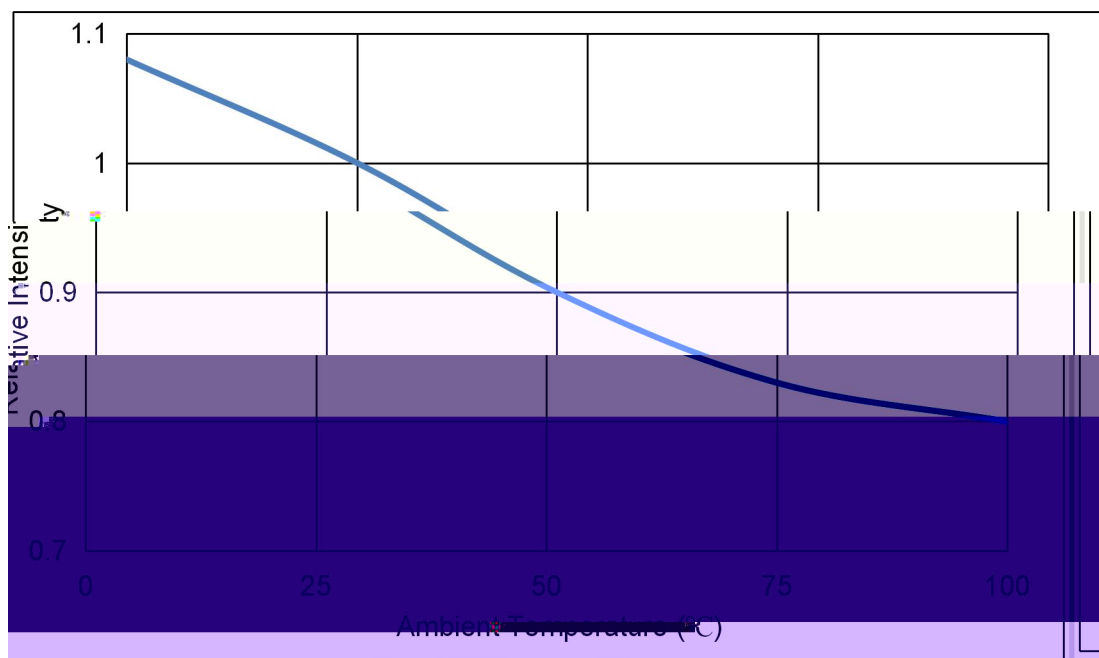

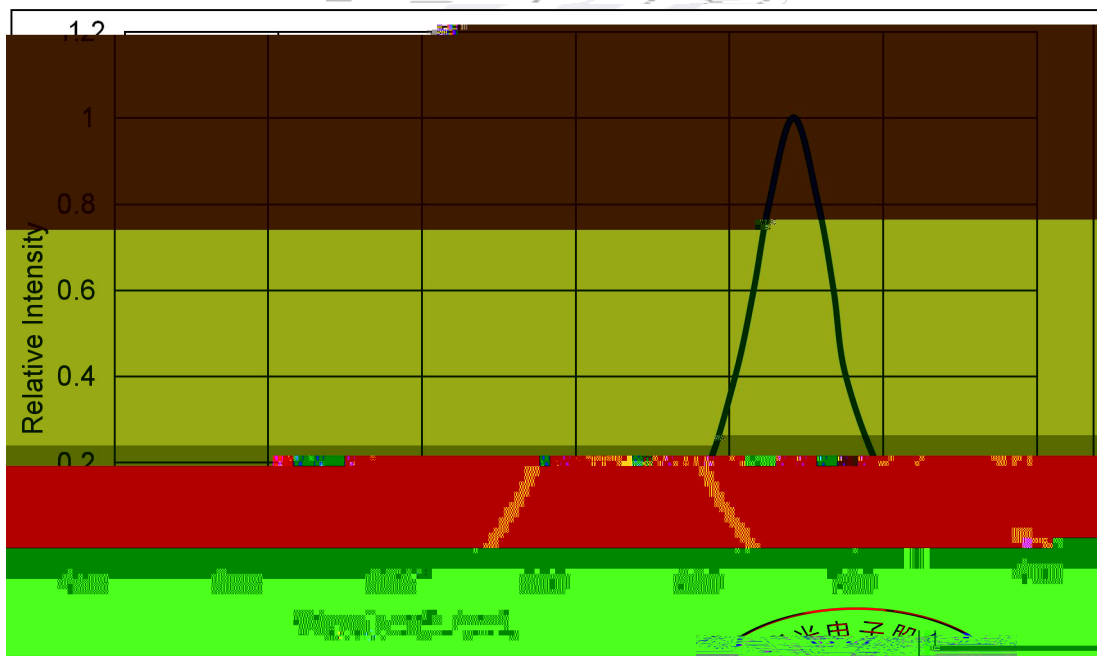
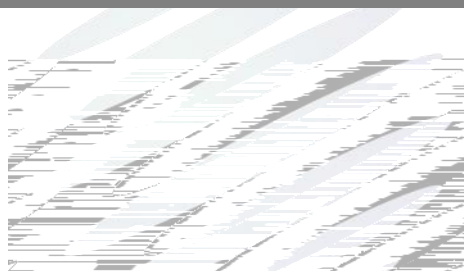
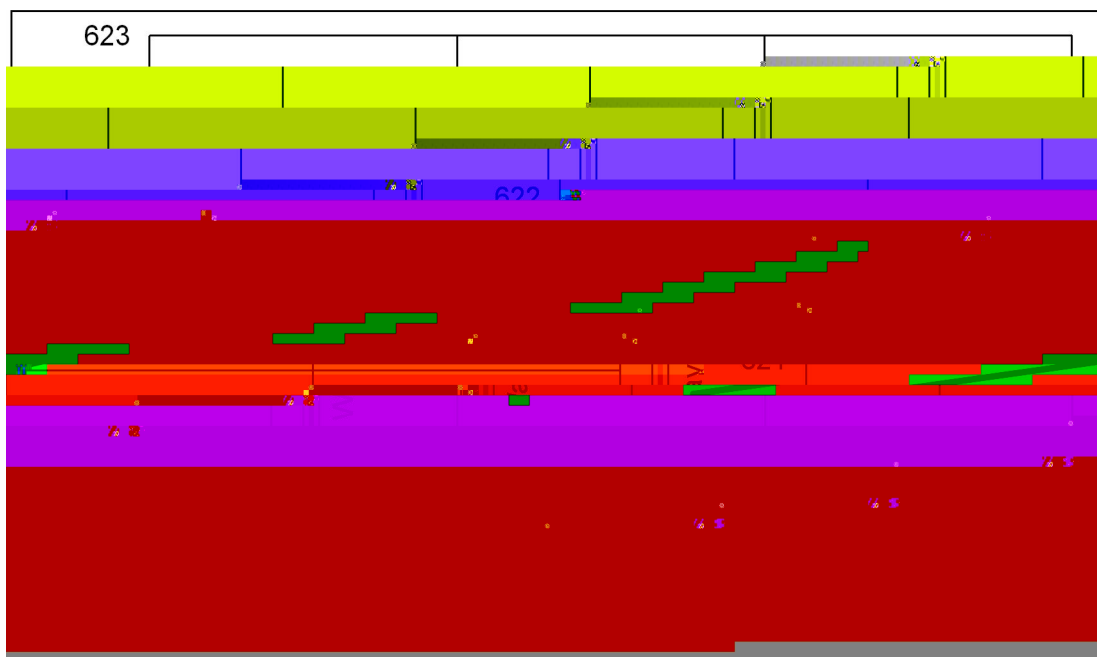

草 承认专用

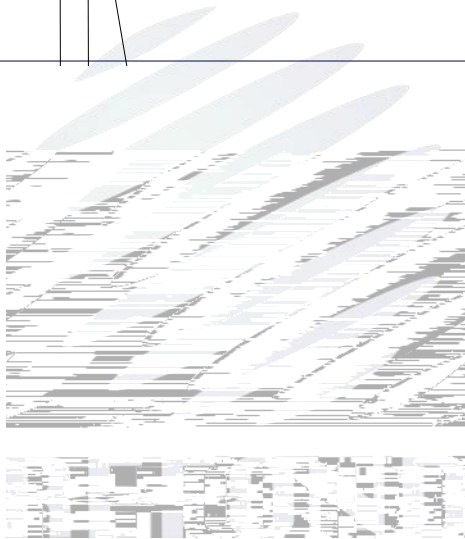
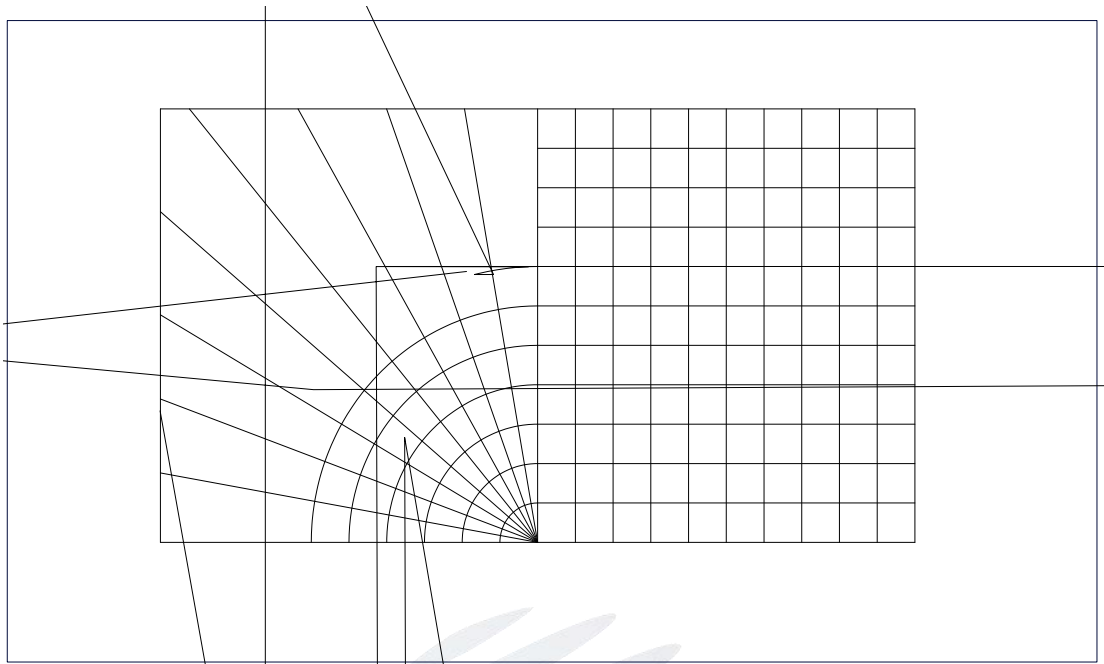

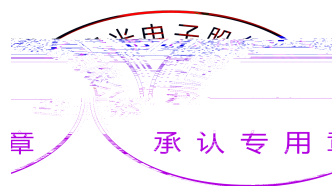
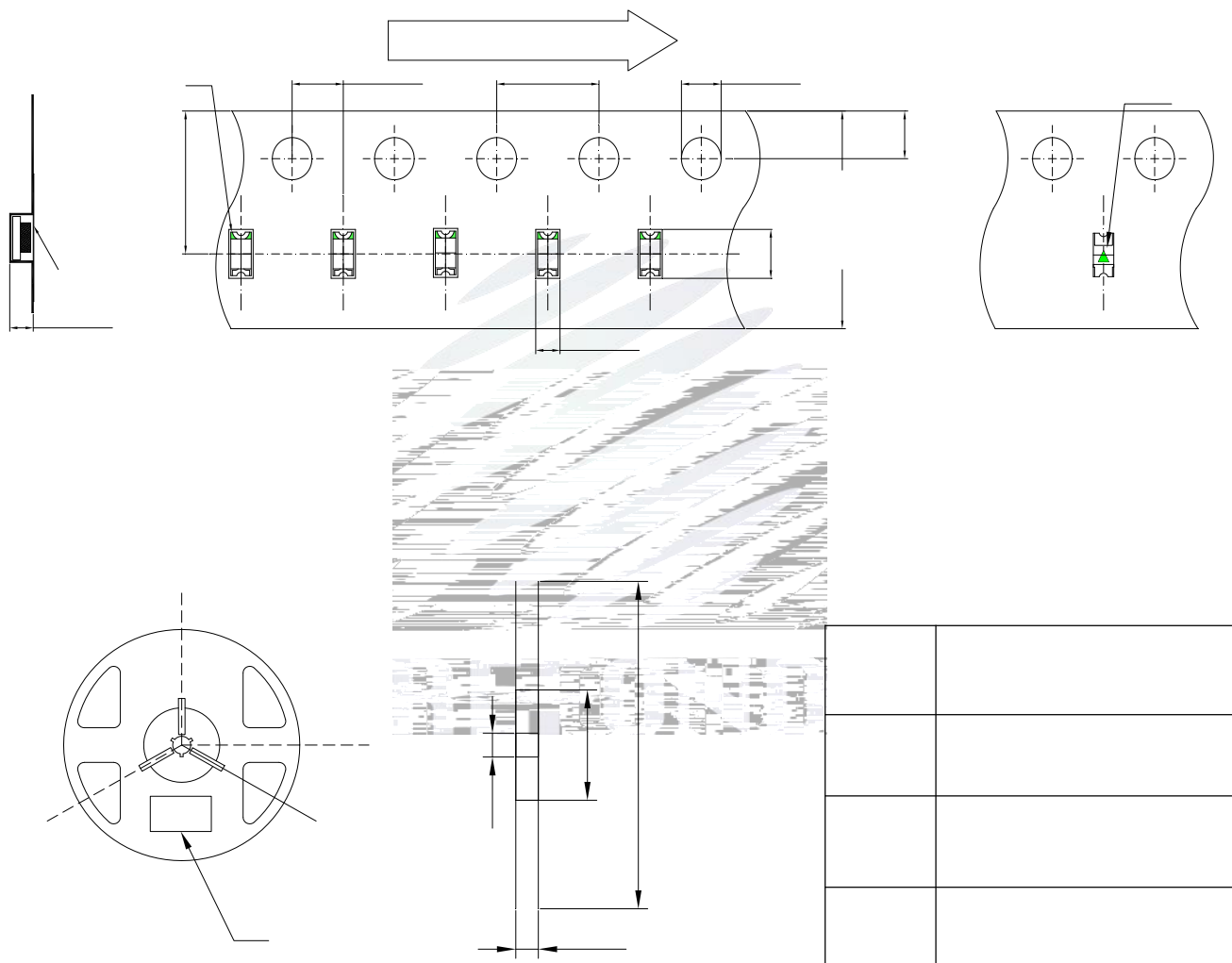

PART NO: .
 SPEC NO:
 LOT NO

BIN CODE:
 Φ: XY:
 VF: WLD:

QTY:
 DATE:



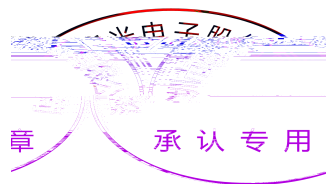
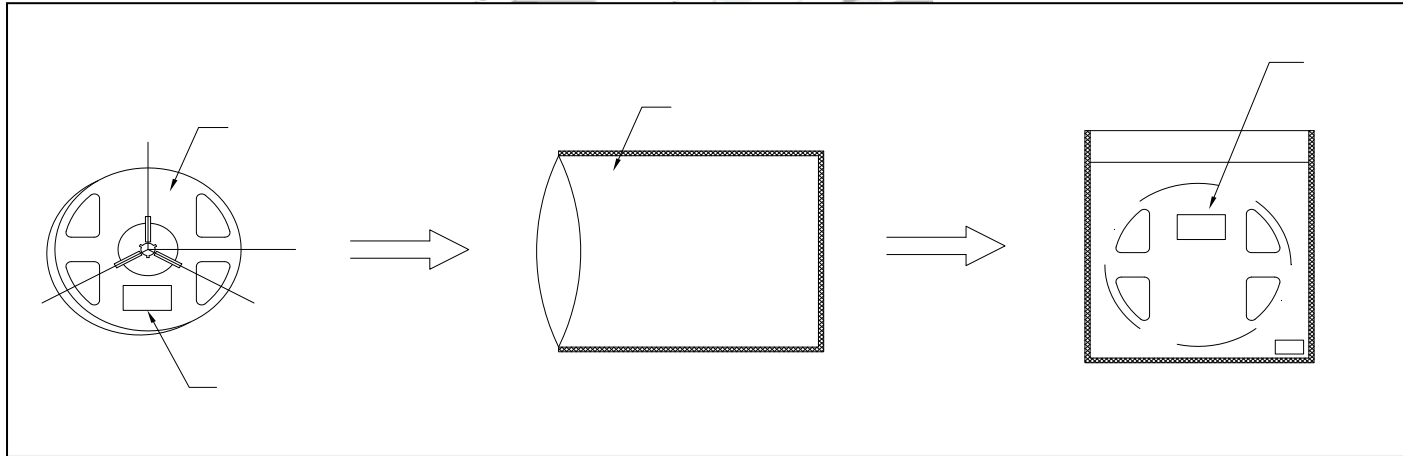

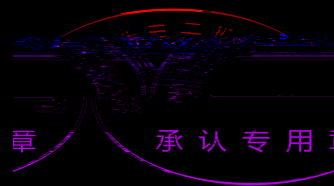

章 承认专用

