

±

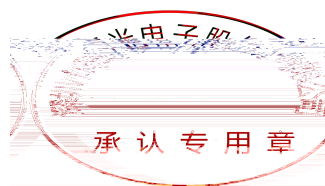

						u

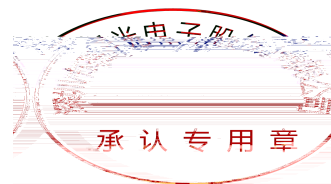

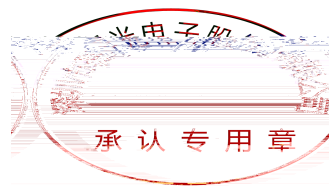
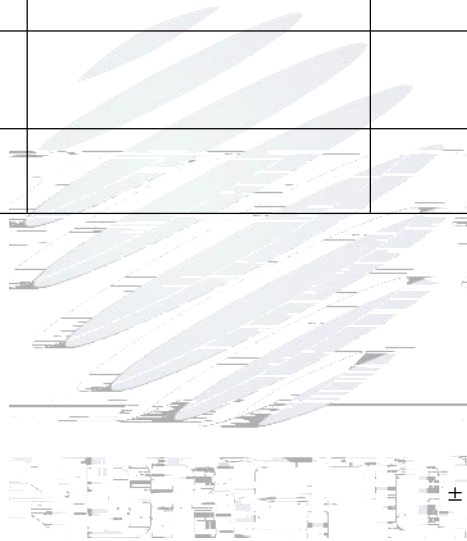

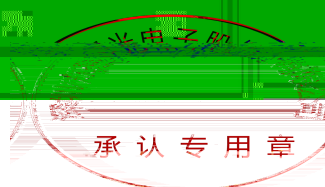
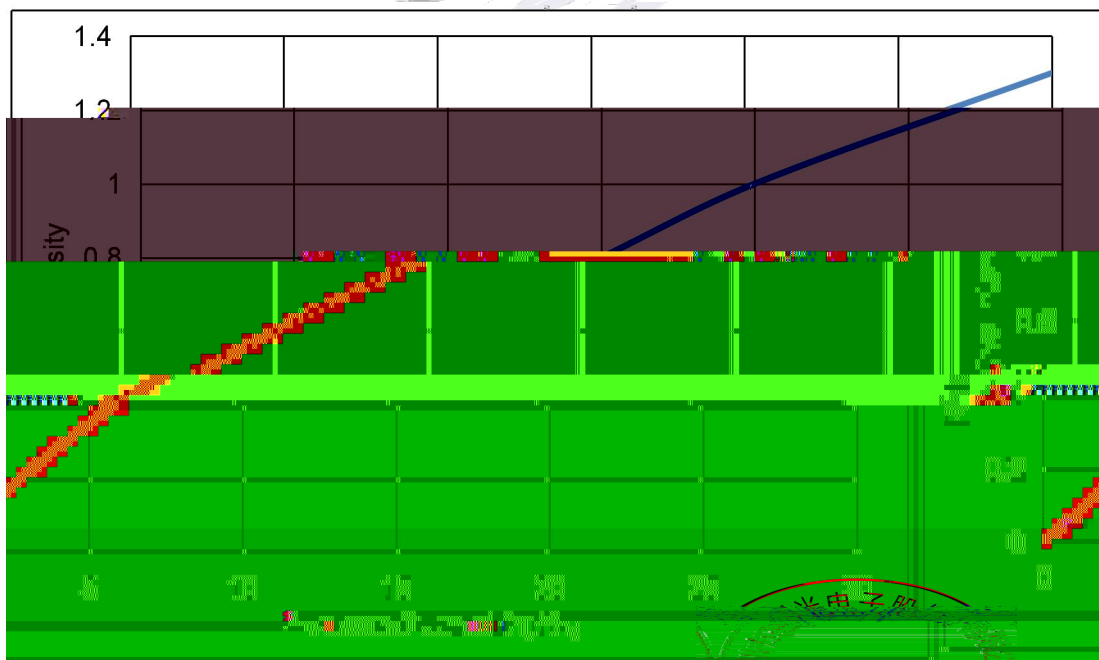
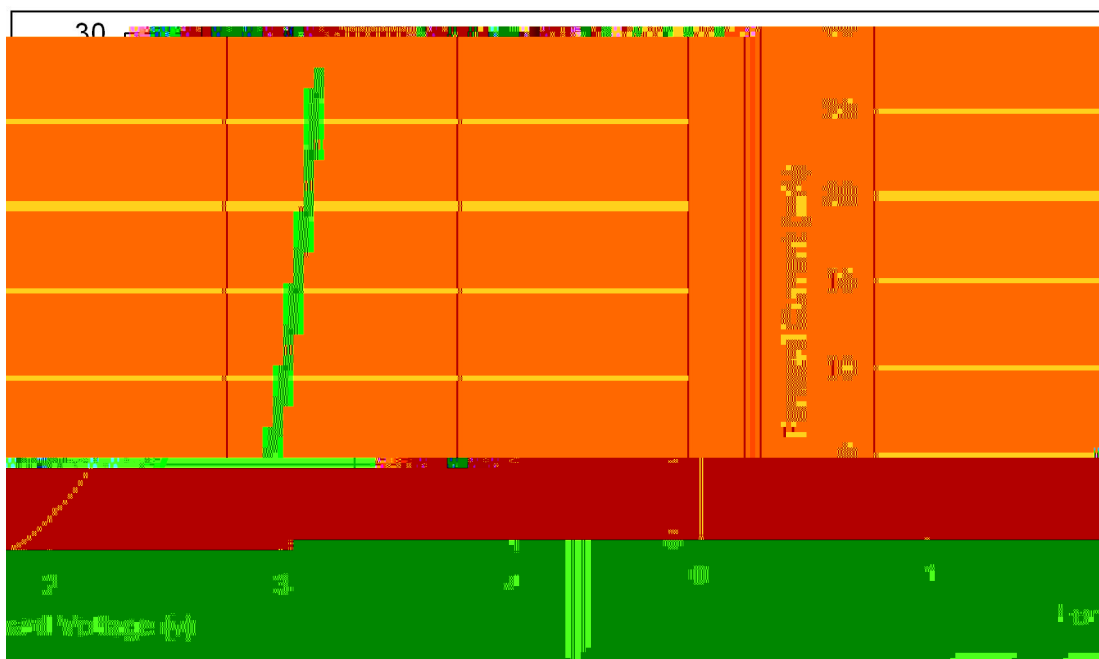

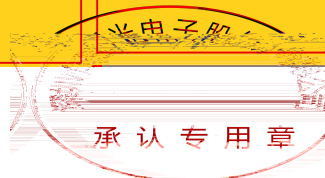
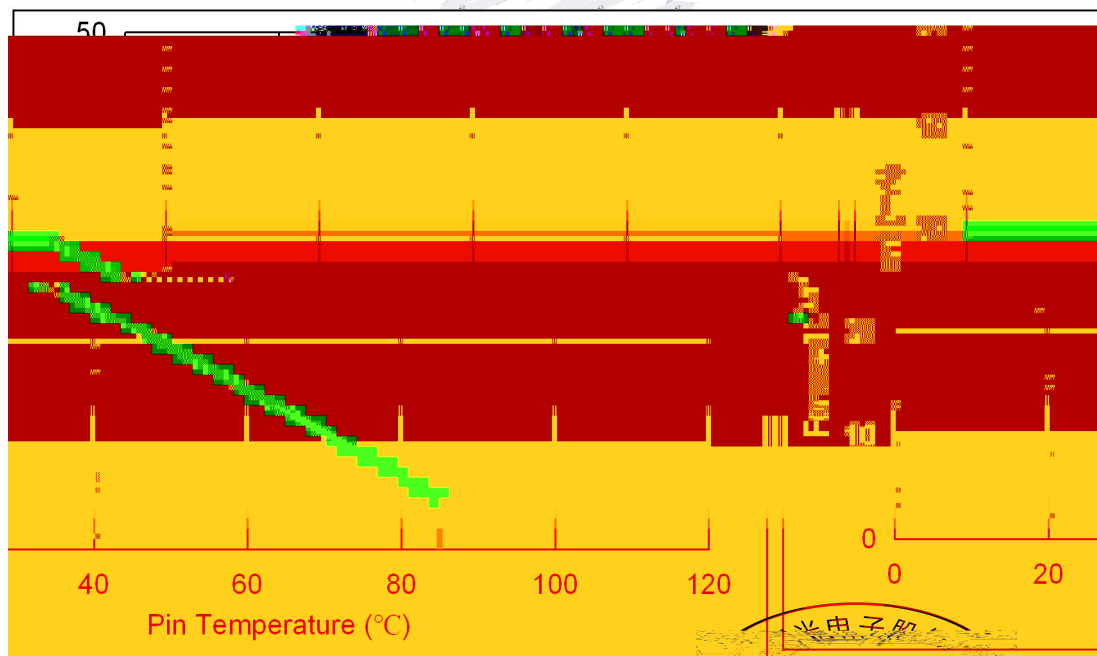
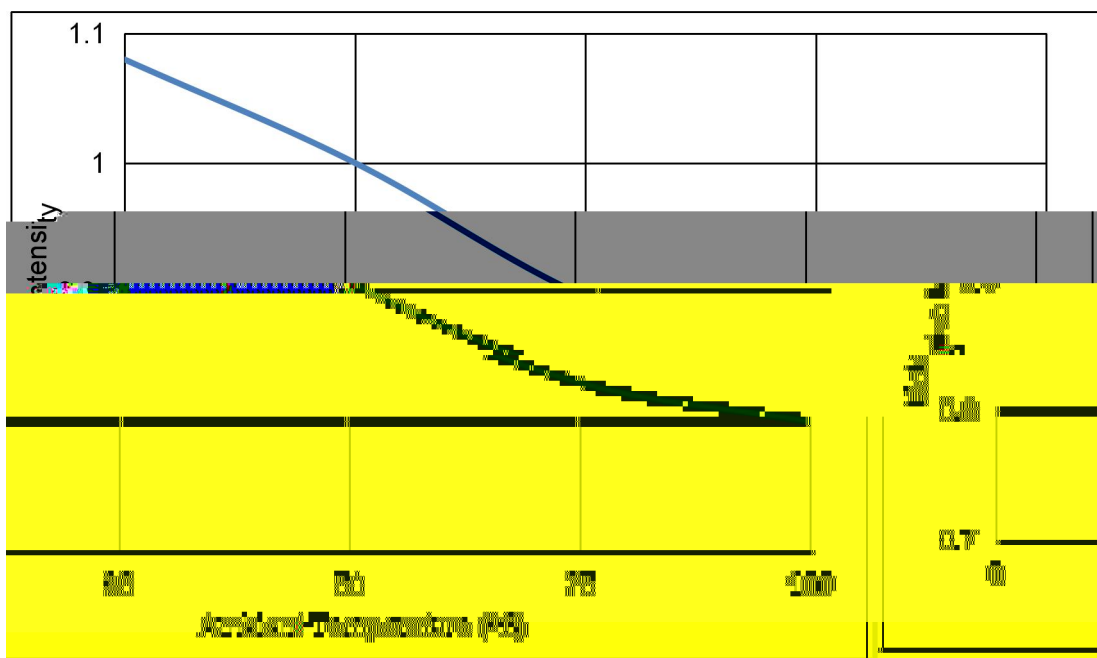

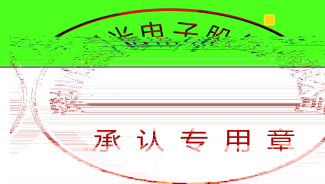
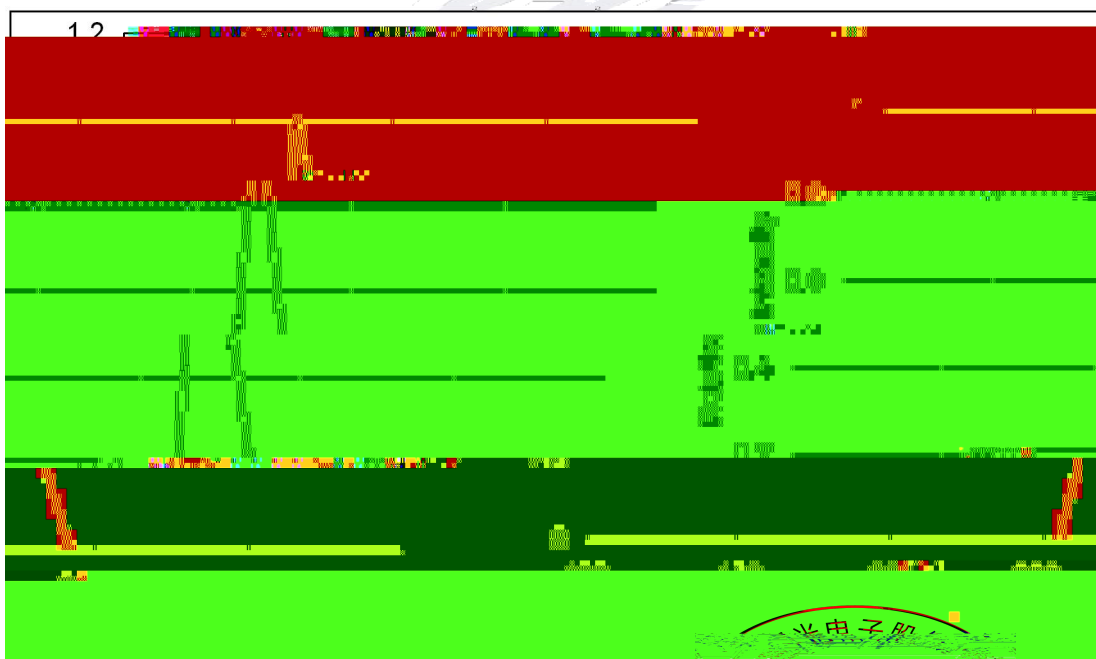
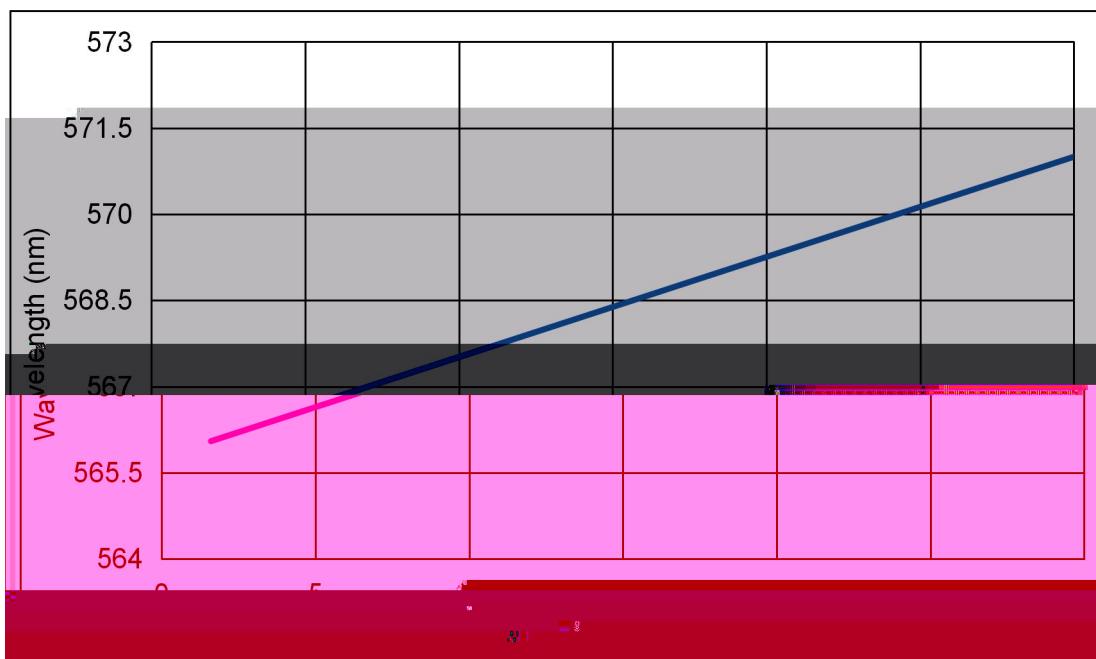

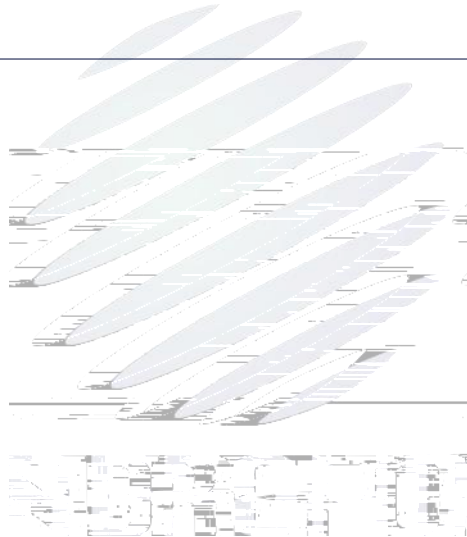
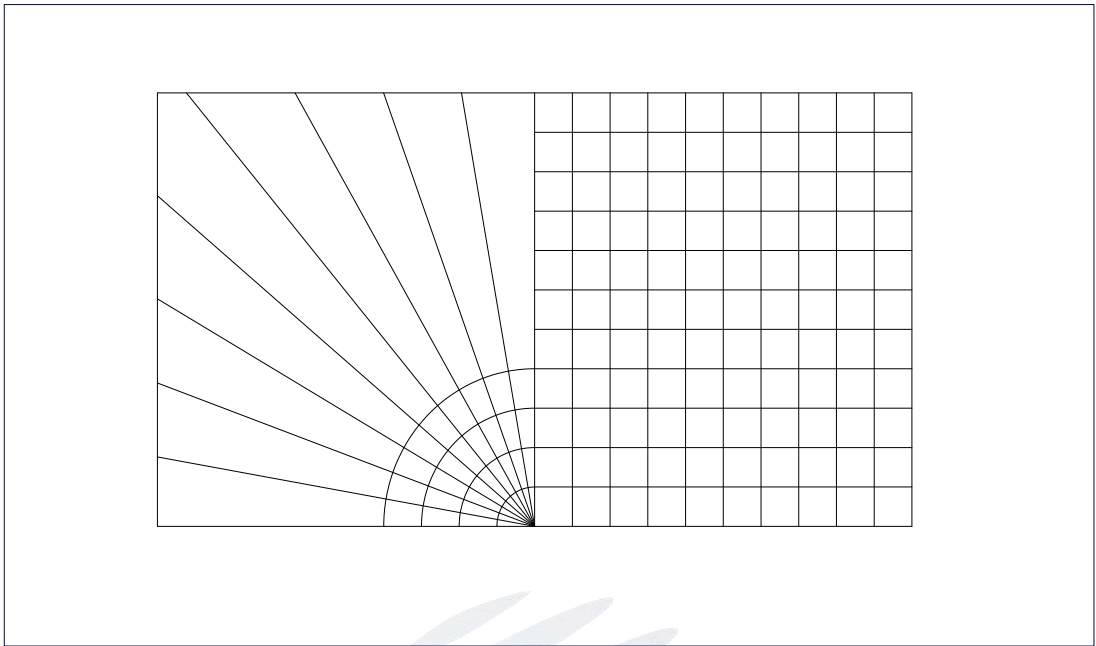

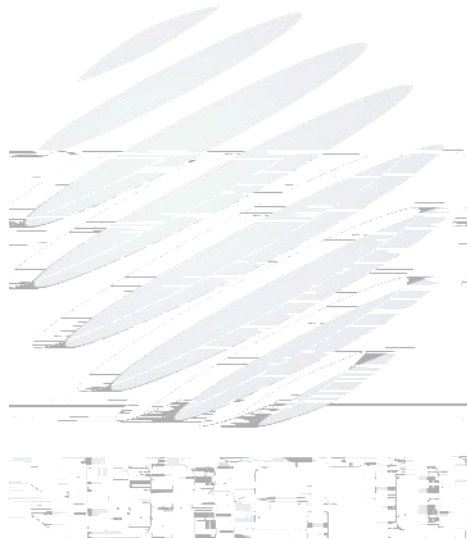

PART NO: .
 SPEC NO:
 LOT NO

BIN CODE:
 Φ: XY:
 VF: WLD:

QTY:
 DATE:



Handwritten lines for notes or additional information.

