

±

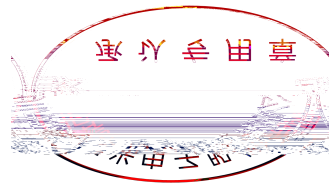







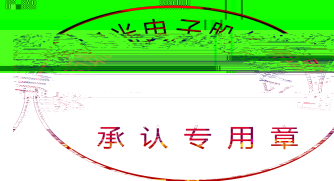
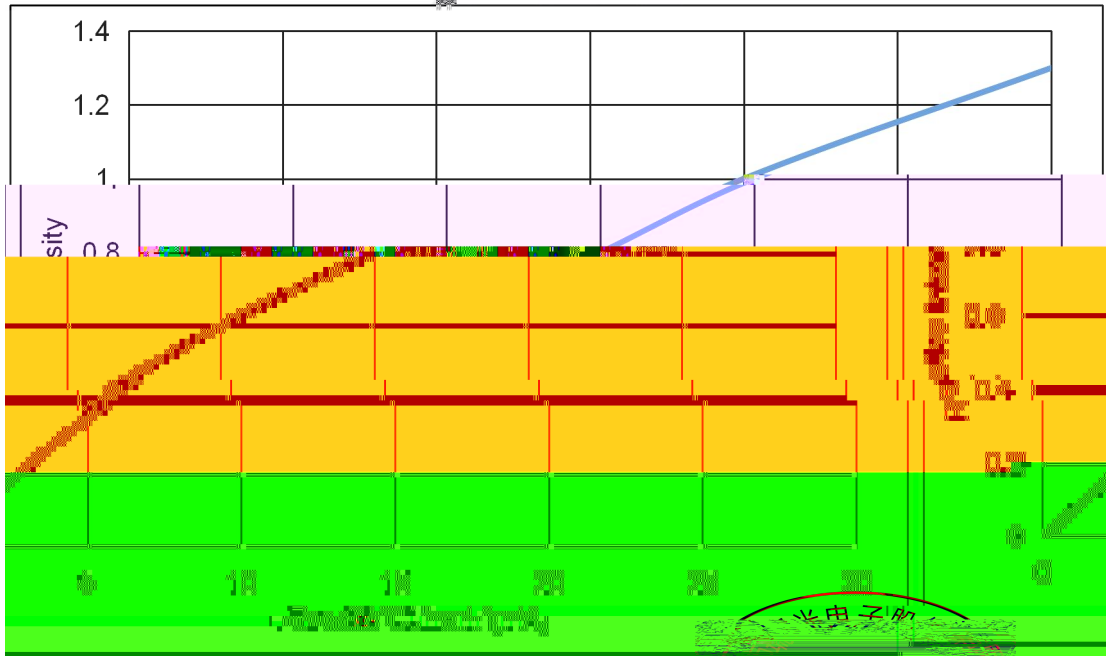
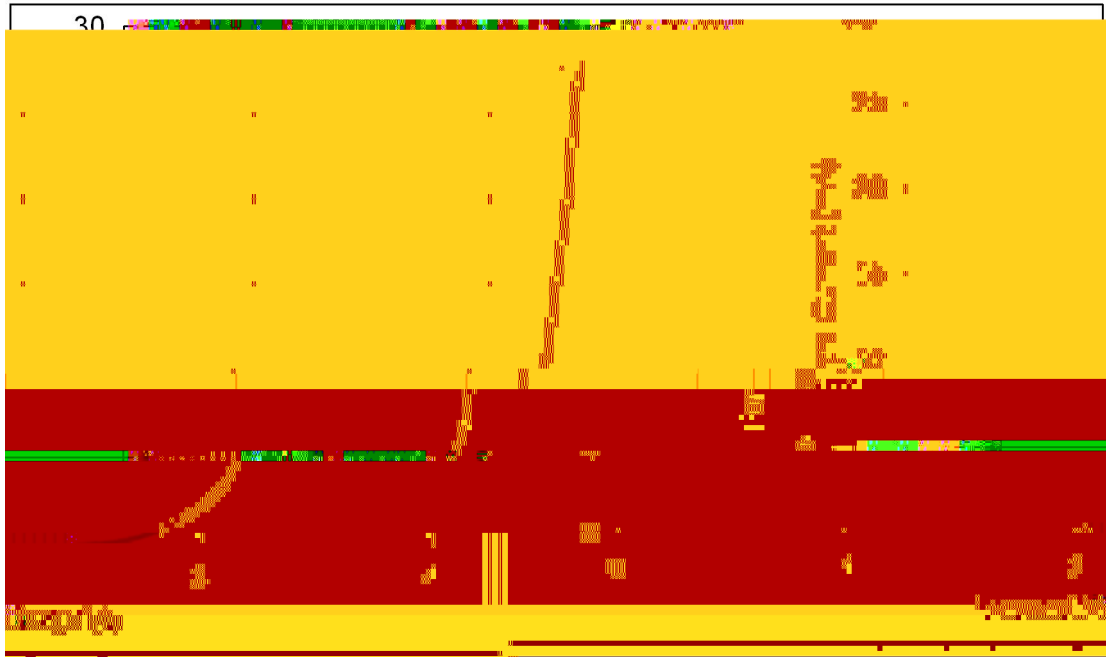

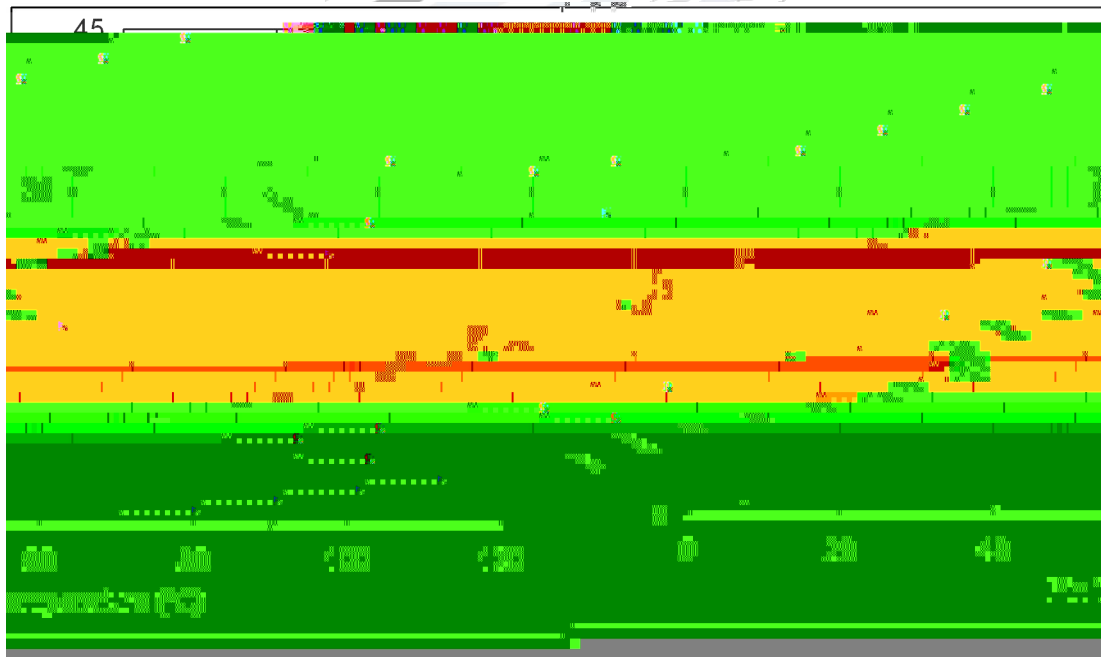
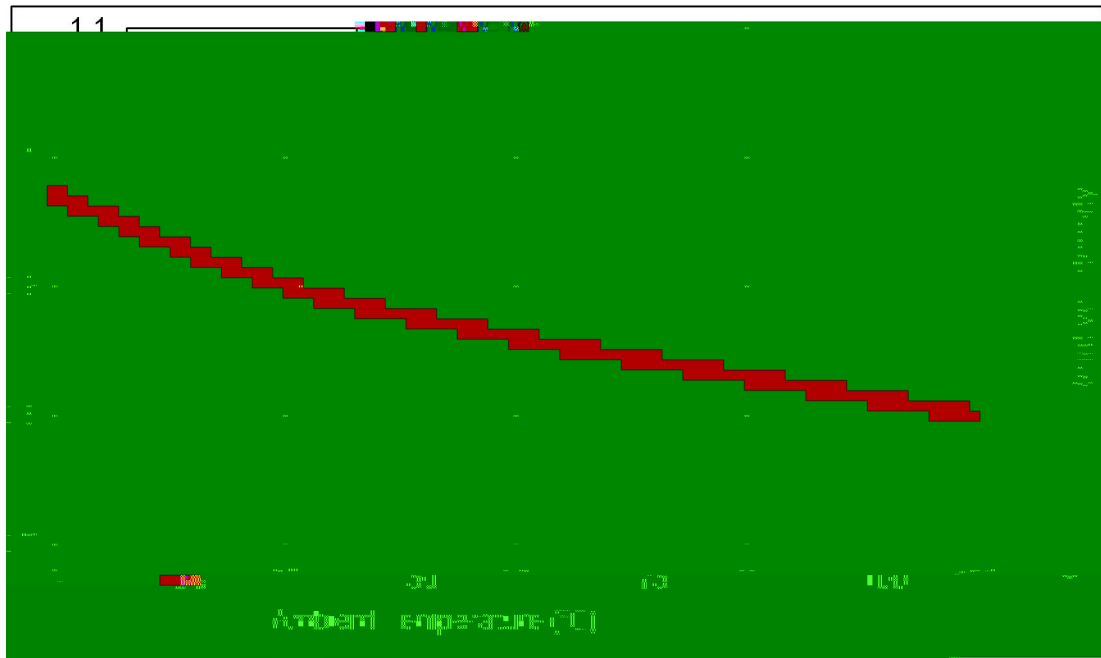

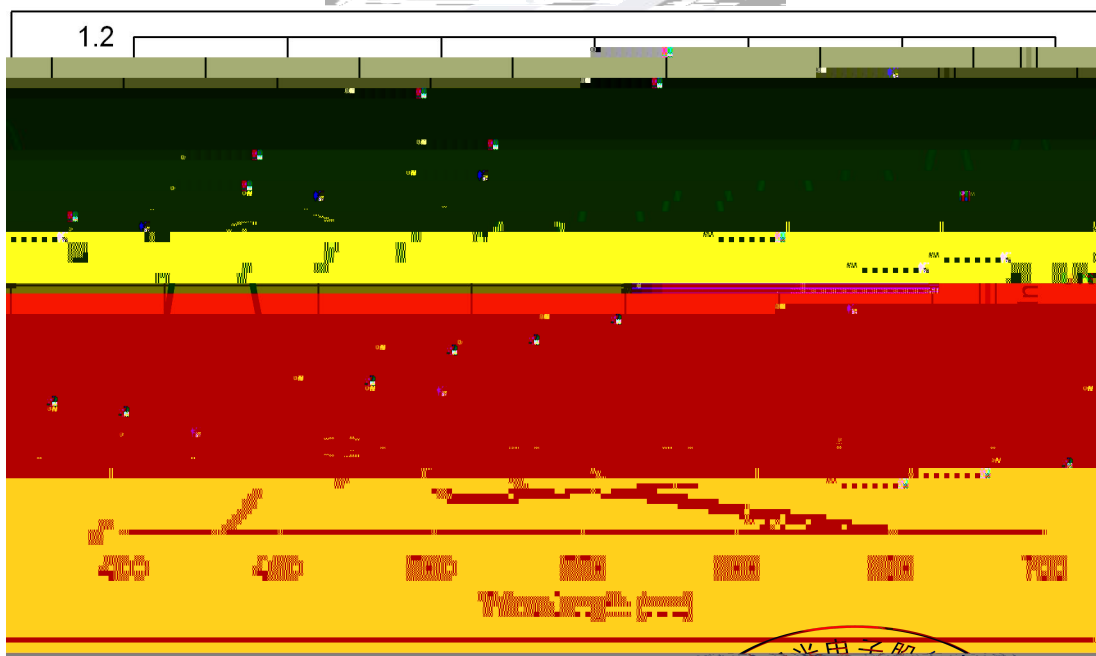
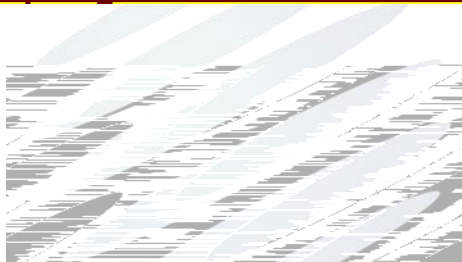
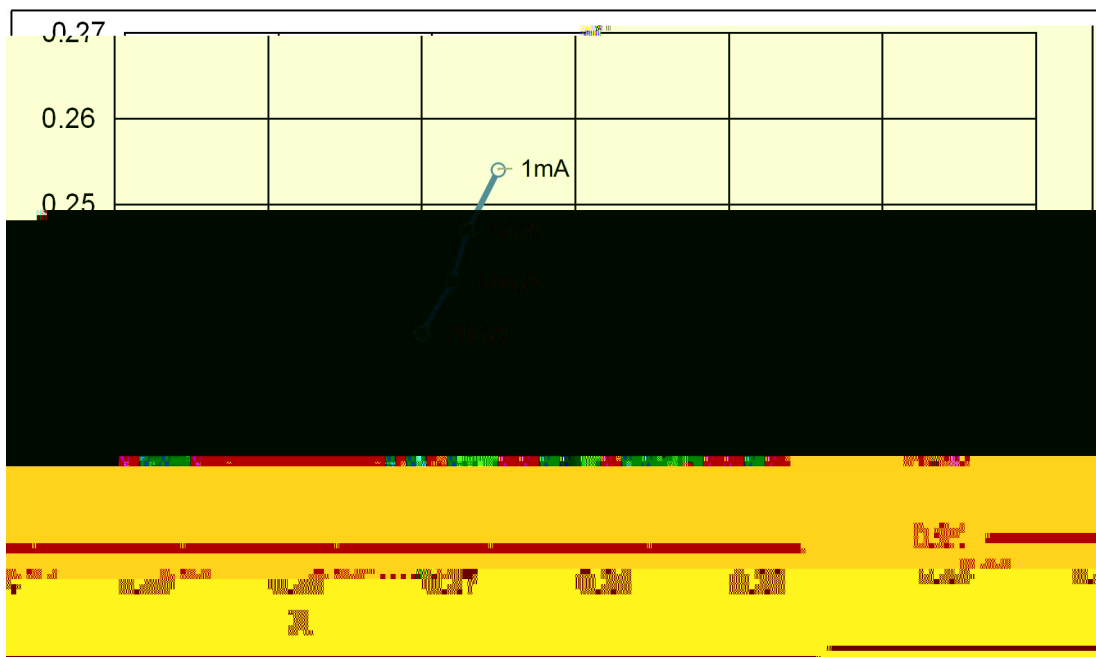

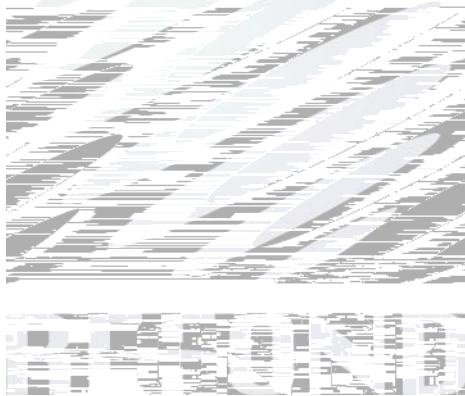
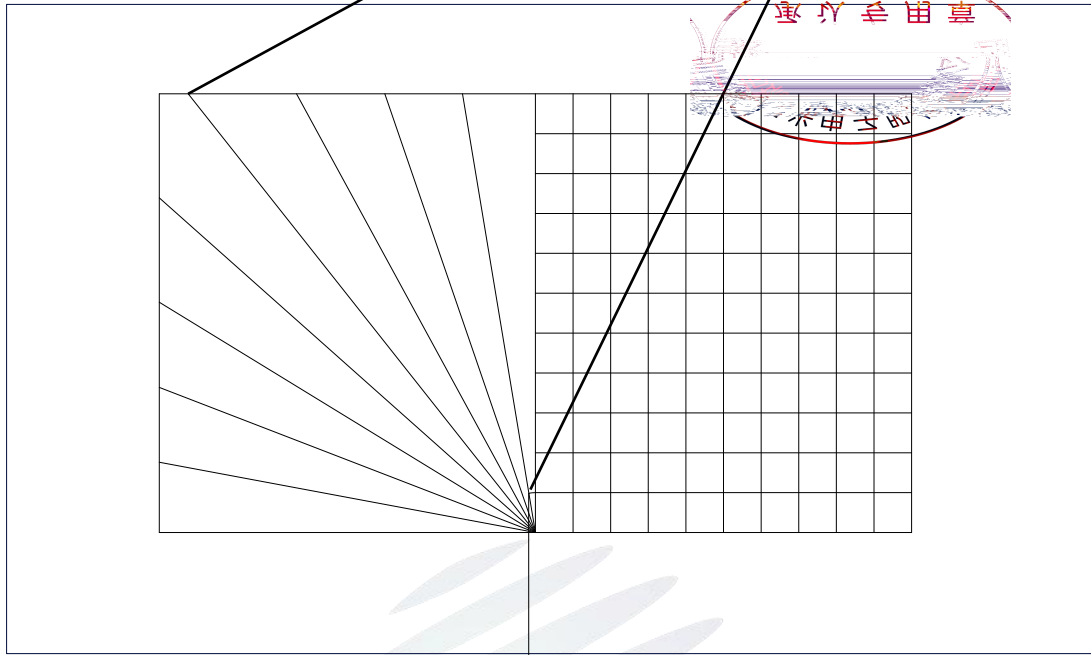

PART NO: _____
 SPEC NO: _____
 LOT NO: _____

BIN CODE:
 Φ: _____ XY: _____
 VF: _____ WLD: _____

QTY: _____
 DATE: _____



