





## 1. Description

### 1.1

The Amber source color devices are made with AlGaInp on Substrate Light Emitting Diode .

Product Package:3.50mmX2.80mmX1.84mm.

GaN

3.50mmX2.80mmX1.84mm.

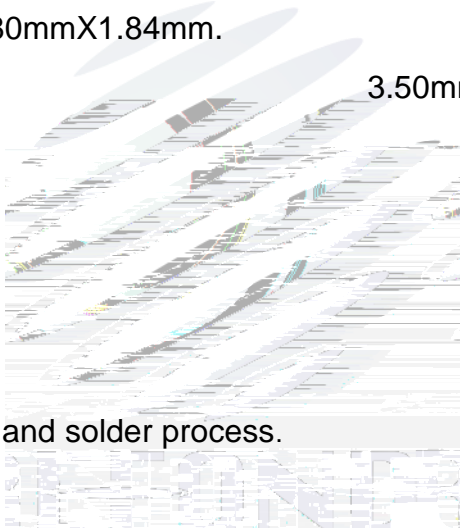

### 1.2 Features

PLCC2 Package.

Extremely wide viewing angle.

Suitable for all SMT assembly and solder process.

Available on tape and reel.

Moisture sensitivity level: Level 2.

## 1.4 Package Dimension

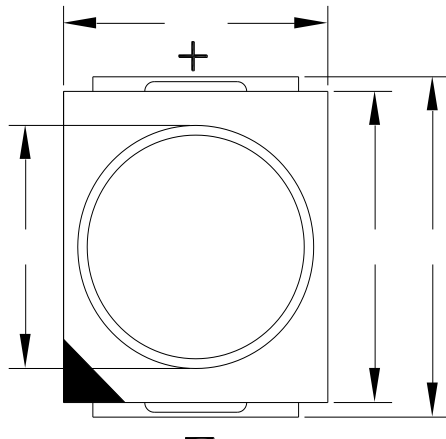

Fig.1-1 Top View

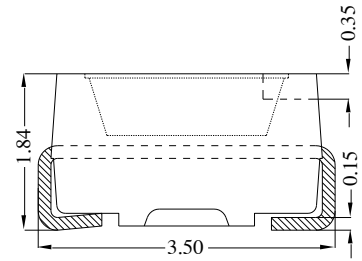

Fig.1-2 Side View

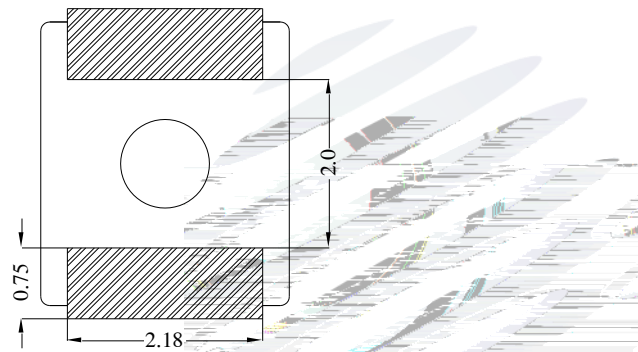

Fig.1-3 Bottom View

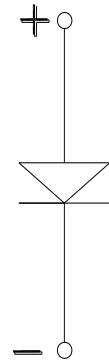

Fig.1-4 Polarity

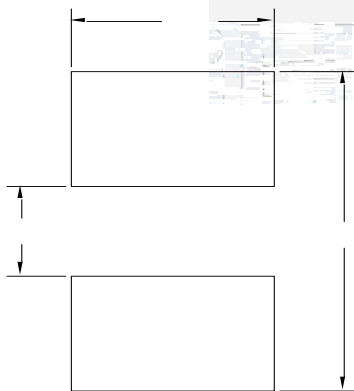
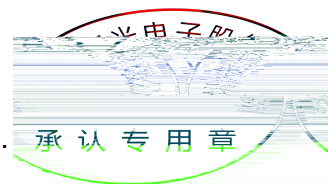

Fig.1-5 Soldering Patterns

### Notes

All dimensions units are millimeters.

All dimensions tolerances are  $\pm 0.2\text{mm}$  unless otherwise noted.



±





## 1.7 Typical Optical Characteristics Curves

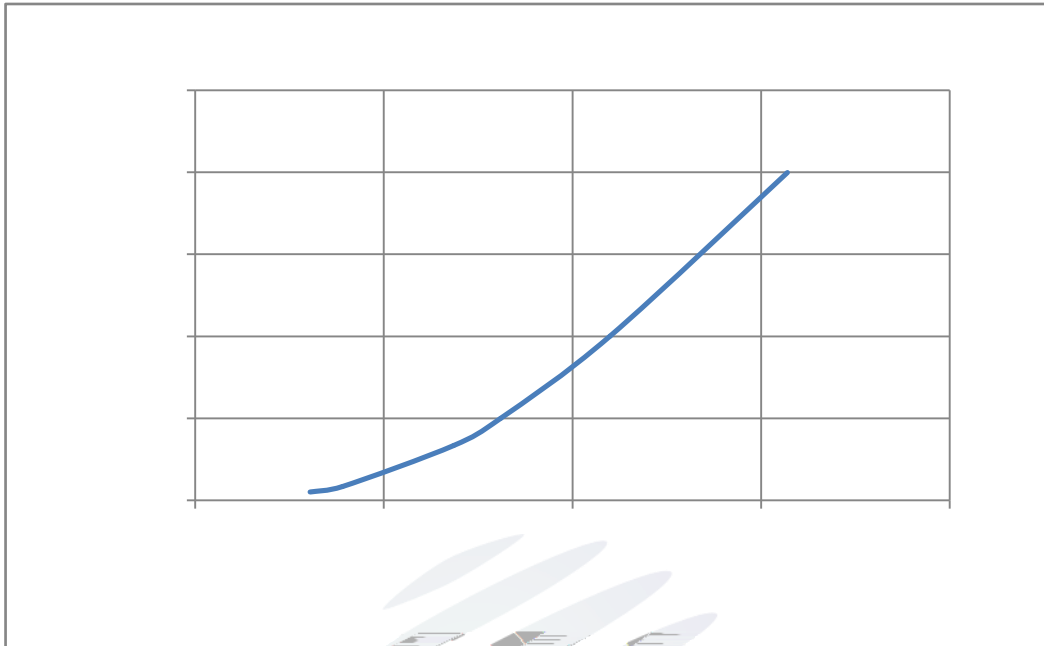

Fig. 1-7 Forward Voltage Vs Forward Current

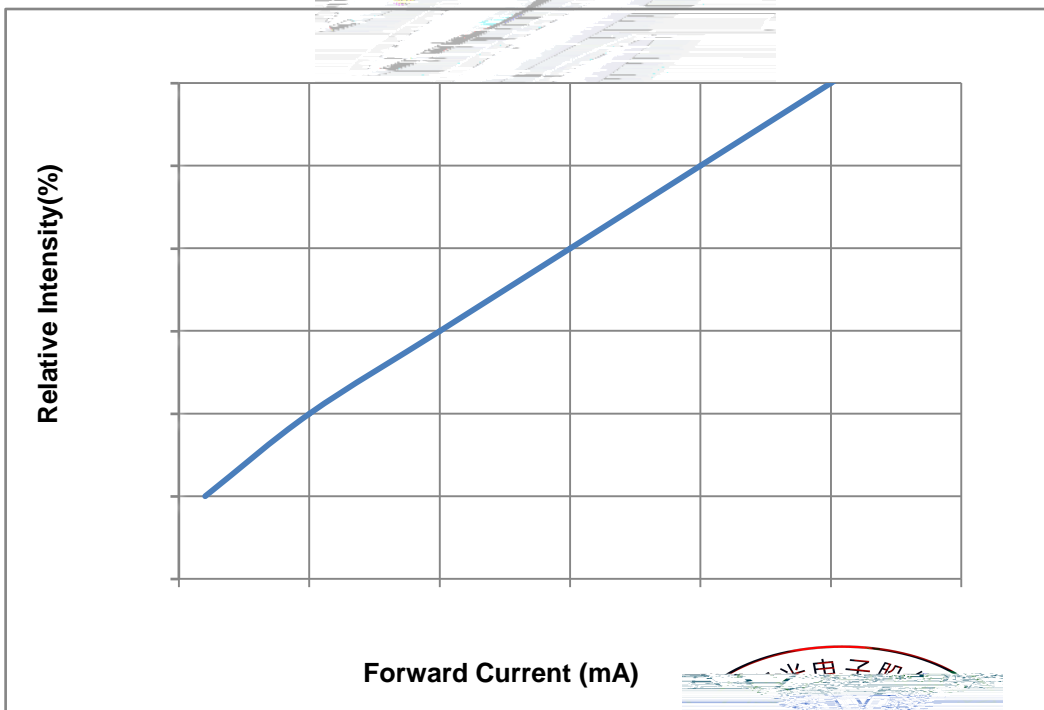
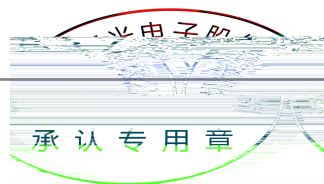
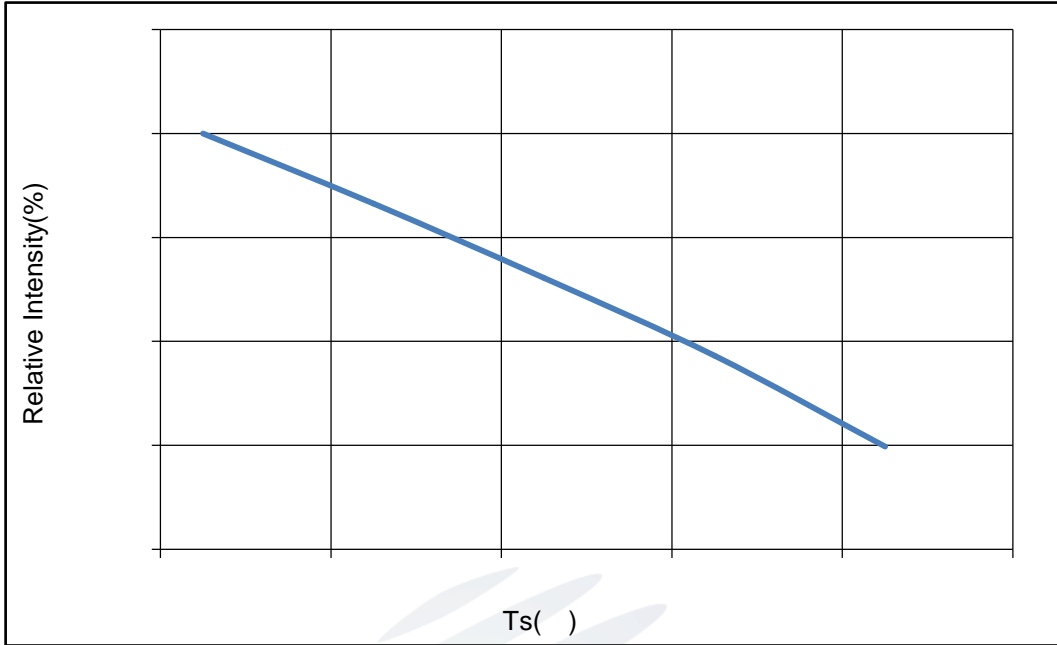

Fig. 1-8 Forward Current Vs Relative Intensity





2

Fig. 1-9 Solder Temperature Vs Relative Intensity



Fig. 1-10 Solder Temperature Vs Forward Current



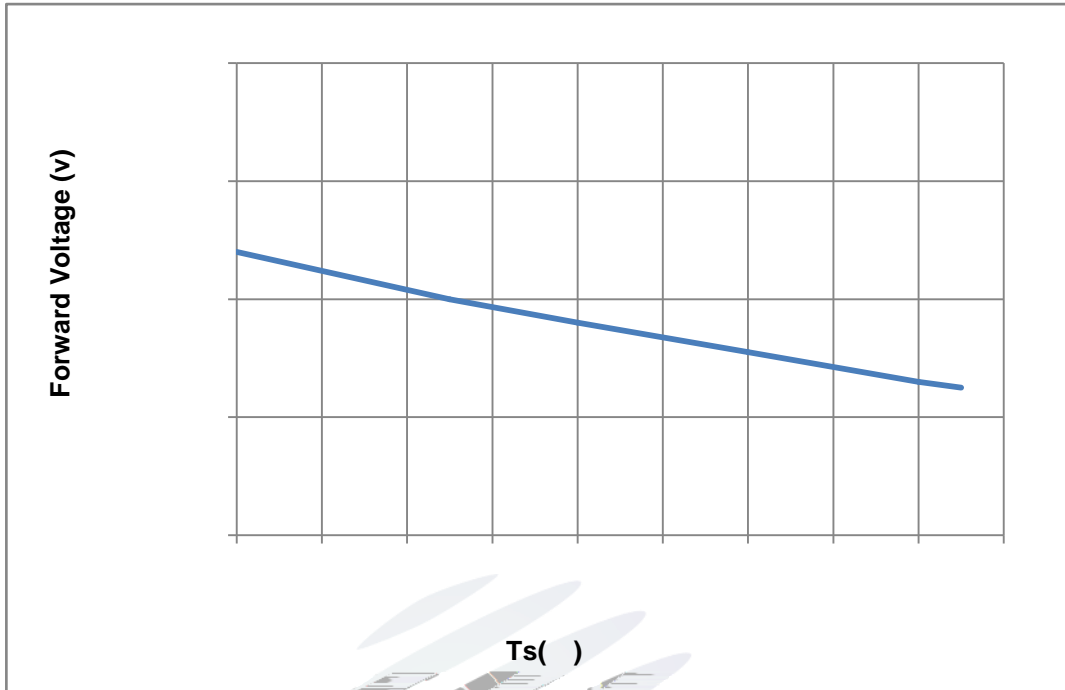

Fig. 1-11 Forward Voltage Vs Solder Temperature

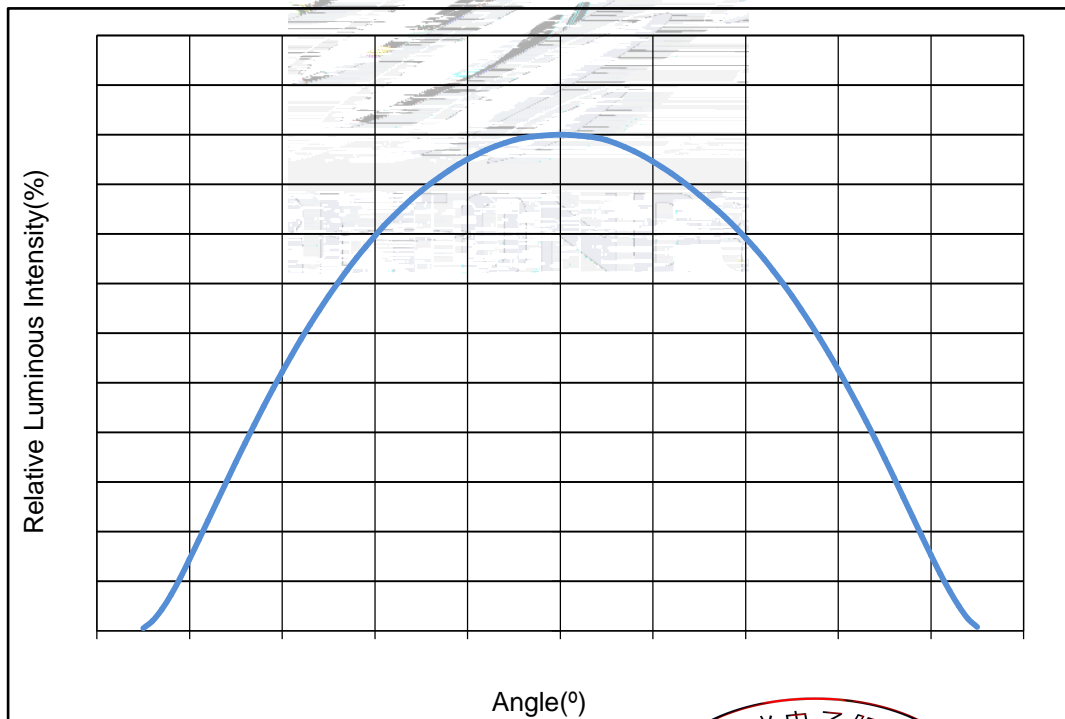
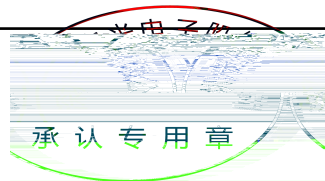

Fig. 1-12 Radiation diagram



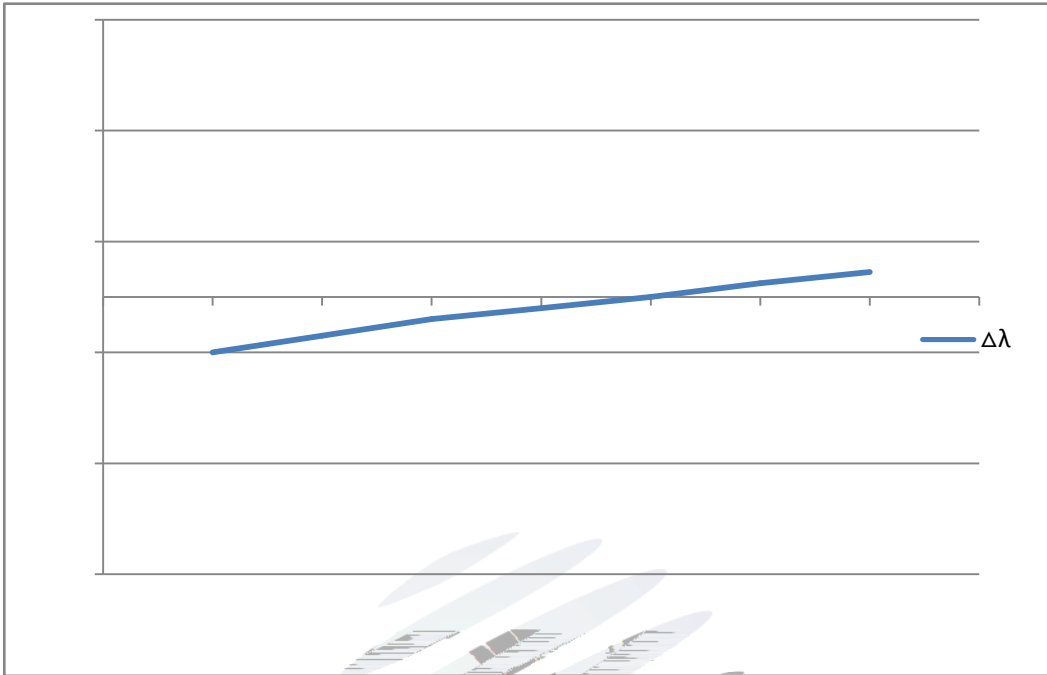

Fig. 1-13 Forward current vs. Dominate wavelength (Ts=25°C)

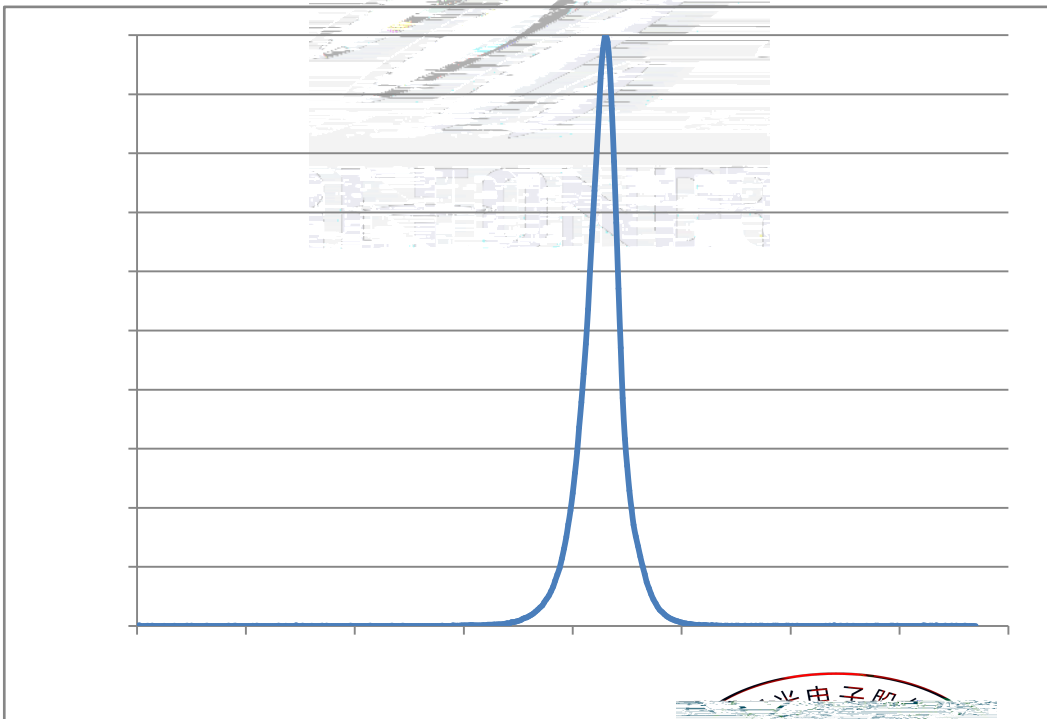
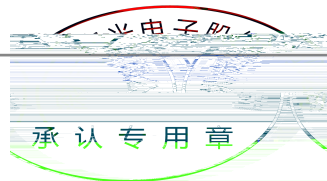

Fig. 1-14 Spectrum Distribution



## 2. Packaging

### 2.1 Packaging Specification

Package:2000pcs/reel.

#### 2.1.1 Carrier Tape Dimension

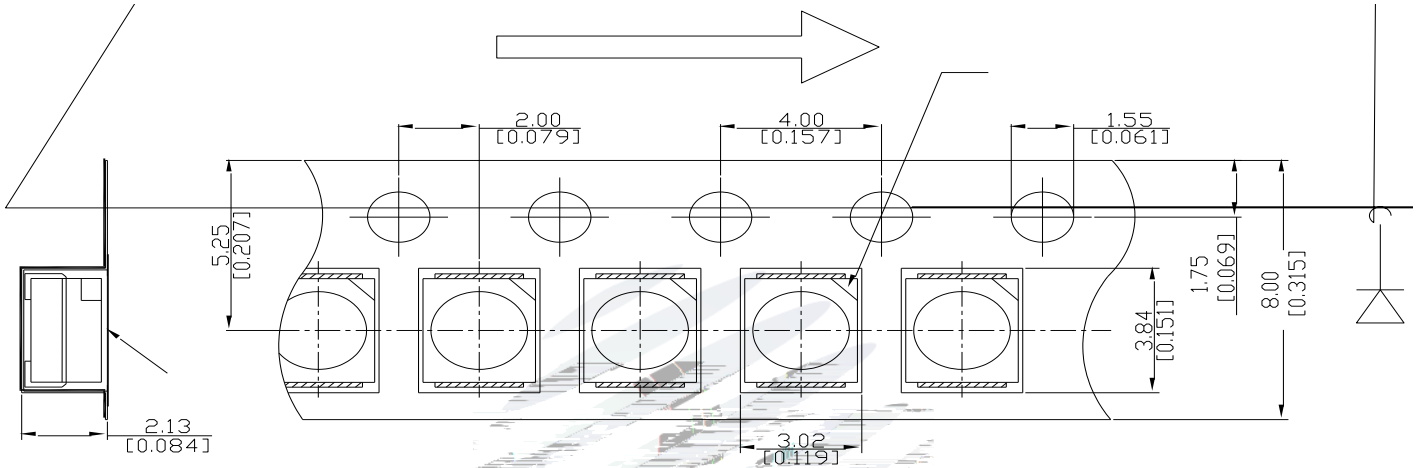

Fig.2-1 Carrier Tape Dimension

#### 2.1.2 Reel Dimension

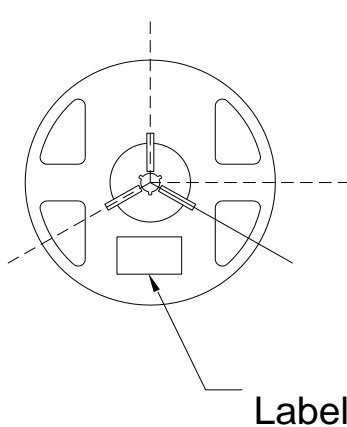

Fig.2-2 Reel Dimension

Reel Dimension

A	8.0±0.1mm
B	178±1mm
C	60±1mm
D	13.0±0.5mm

#### Notes

The tolerances unless mentioned ±0.1mm. Unit : mm

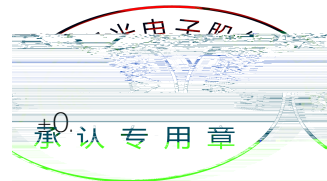

### 2.1.3 Label Form Specification

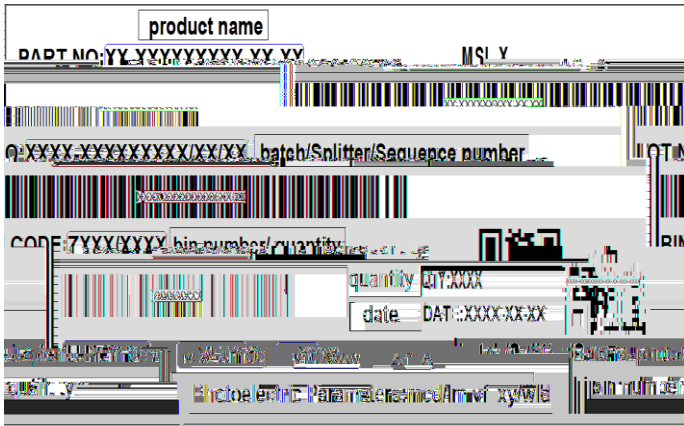

Fig. 2-3 Label Form Specification

#### Specification

PART NO.	Part Number
SPEC NO.	Spec Number
LOT NO.	Lot Number
BIN CODE	Bin Code
	Luminous flux
XY	Chromaticity Bin
V <sub>F</sub>	Forward Voltage
WLD	Wavelength
QTY	Packing Quantity
DATE	Made Date

### 2.2 Moisture Resistant Packing

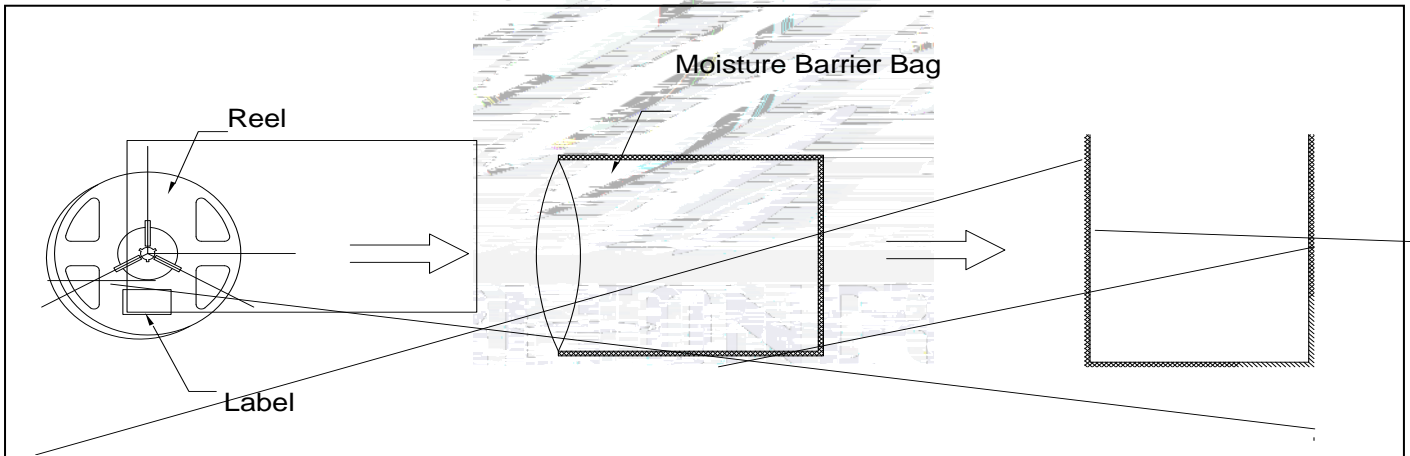
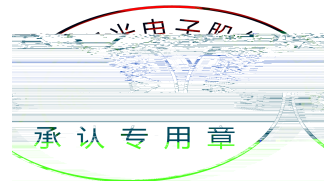

Fig.2-4 Moisture Resistant Packing



## 2.3 Cardboard Box

Fig.2- Cardboard Box

## 2.4 Reliability Test Items And Conditions

Table 2-3 Reliability Test Items And Conditions

RIemsTQQ>BDC q363.9 35

Test Items	Ref.Standard	Test Condition	Time	Quantity	Ac/Re
Reflow	JESD22-B106	Temp:260			/

High Temperature High Humidity Life Test	JESD22-A101	85 / 85%RH I <sub>F</sub> =20mA	1000hrs.	20pcs.	0/1
Temperature Humidity Storage	JEITA ED-4701 100 103	T <sub>A</sub> =85 R <sub>H</sub> =85%	1000hrs.	20pcs.	0/1

## 2.5 Criteria For Judging Damage

Table 2-4 Criteria For Judging Damage

Test Items	Symbol	Test Condition	Criteria For Judgement	
			Min.	Max.
Forward Voltage	V <sub>F</sub>	I <sub>F</sub> =20mA	-	U.S.L*)x1.1
Reverse Current	I <sub>R</sub>	V <sub>R</sub> = 5V	-	U.S.L*)x2.0
Luminous Flux		I <sub>F</sub> =20mA	L.S.L*)x0.7	-

### Notes

- 1.U.S.L: Upper standard level                      L.S.L: Lower standard level
- 2.The above reliability tests is based on the verification of a single/strip LED of Refond's existing experimental platform,the reliability experiment was taken under good heat dissipation conditions. when customers applies the LED to the series and parallel circuit, should take consideration of all the factors such as the current, voltage distribution, heat dissipation and others.

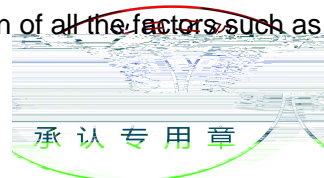



Time limit classification of peak temperature time		
$t_p$	10	Max 10s
( $T_P$ ) 5 °C		Hold time within 5 °C
with the actual peak temperature (TP)	30	







energy. The result can be a significant loss of light output from the fixture. Knowledge of the properties of the materials selected to be used in the construction of fixtures can help prevent these issues. Refond advises against the use of any chemicals or materials that have been found or are suspected to have an adverse affect on device performance or reliability. To verify compatibility, Refond recommends that all chemicals and materials be tested in the specific application and environment for which they are intended to be used. Attaching LEDs, do not use adhesives that outgas organic vapor.

(4) Handle the component along the side surface by using forceps or appropriate tools; Do not directly touch or Handle the silicone lens surface, it may damage the internal circuitry.

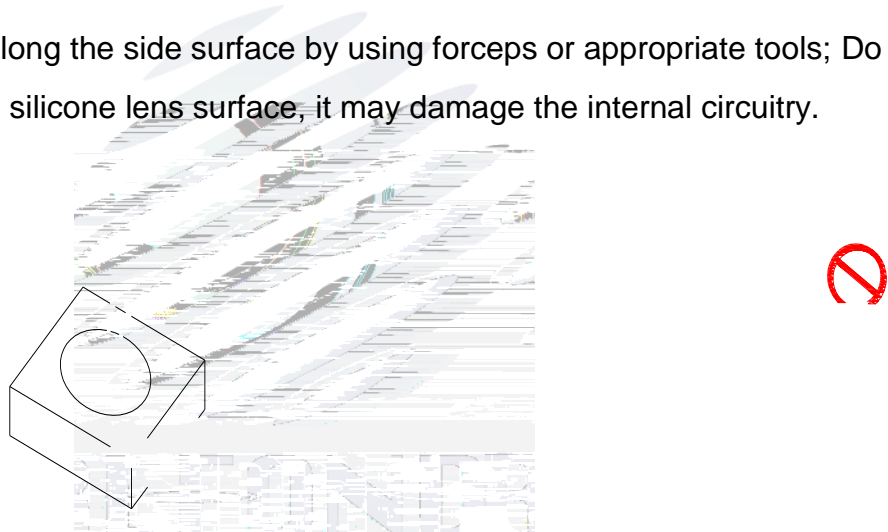
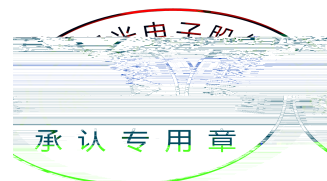

Fig 4-1 Handling Precautions

(5) In designing a circuit,the current through each LED can not exceed the absolute maximum rating specified for each LED.In the mean while,resistors for protection should be applied,other wise slight voltage shift will cause big current change,burn out may happen. The driving circuit must be designed to allow forward voltage only when it is ON or OFF.If the reverse voltage is applied to LED, migration can be generated resulting in LED damage.



(6) Thermal Design is paramount importance because heat generation may result in the Characteristics decline, such as brightness decreased, Color change and so on. Please consider the heat generation of the LEDs when making the system design. LED

(7) Compared to standard encapsulants, silicone is generally softer, and the surface is more likely to attract dust, requiring special care during processing. In cases where a minimal level of dirt and dust particles cannot be guaranteed, a suitable cleaning solution must be applied to the surface after the soldering of components. Refond suggests using isopropyl alcohol for cleaning. In case other solvents are used, it must be assured that these solvents do not dissolve the package or resin. Ultrasonic cleaning is not recommended. Ultrasonic cleaning may cause damage to the LED.



Table 4-1 Storage

Conditions		Temperature	Humidity	Time
Storage	Before Opening Aluminum Bag	30	75%	Within 1 Year From Date
	After Opening Aluminum Bag	30	60%	Recommended for use within 24 hours
Baking		60±5	-	24hours 24

(8) If the moisture absorbent material silica gel

following condition 65 5 for above 24 hours.

±

If the package is flatulence or damaged, please notify the sales staff to assist.

(9) Similar to most Solid state devices; LEDs are sensitive to Electro-Static Discharge (ESD) and Electrical Over Stress (EOS).

(10) Other points for attention, please refer to our relevant information.

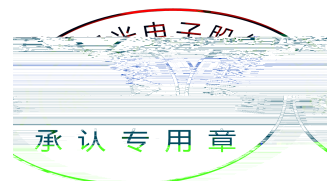





www.refond.com

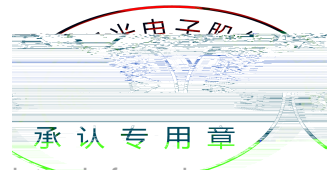

Declare

This specification is written both in English and in Chinese and the latter is formal.