

SPECIFICATION

REFOND P/N

RF-WMRB14DS-WY-F

R&D

Mass Production

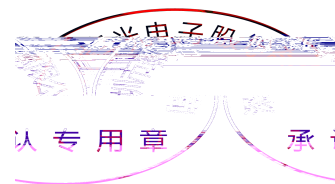

Contents

- 1. Description
- 1.1 General Description

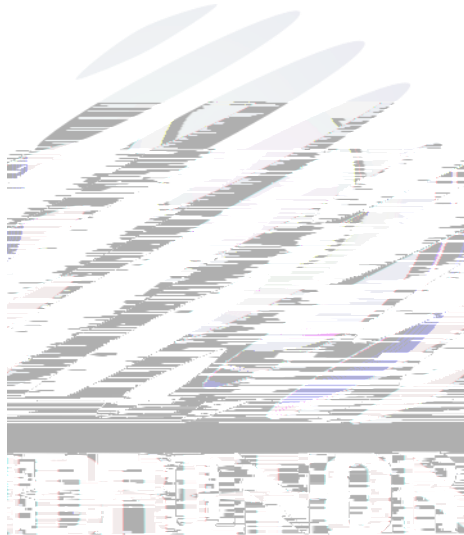

1. Description 产品介绍

1.1 产品描述

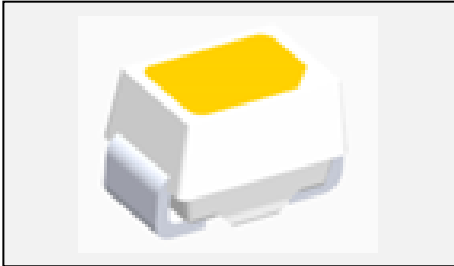

The Yellow LED, which was fabricated by using a blue chip and the phosphor.

Product Package: 2.2mmX1.4mmX1.3mm.

LED

2.2mmX1.4mmX1.3mm

1.2 Features 产品特点

PLCC2 Package. PLCC2

Extremely wide viewing angle.

Suitable for all SMT assembly and solder process.

Available on tape and reel.

Moisture sensitivity level: Level 2.

Level2

Compliance with RoHS and REACH.

RoHS REACH

Qualifications: The product qualification test plan is based on the guidelines of AEC-Q101 Stress Test Qualification for Automotive Grade Discrete Semiconductors

AEC-Q101

1.3 Application 产品应用

Automotive Interior Lighting.

Switches.

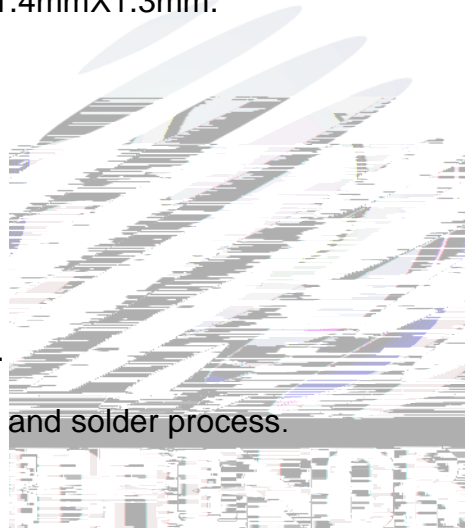

SMT

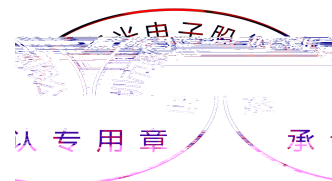

1.4 Package Dimension 封装尺寸

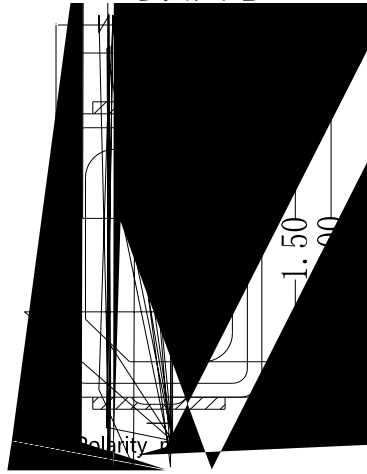

Fig.1-1 Top View

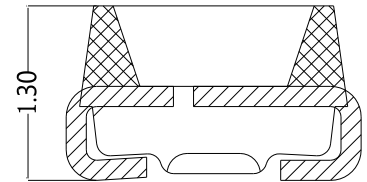

Fig.1-2 Side View

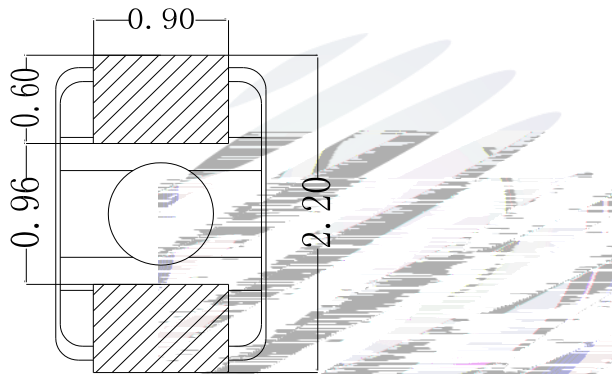

Fig.1-3 Bottom View

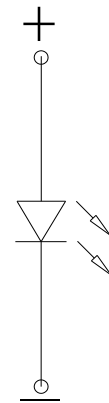

Fig.1-4 Polarity

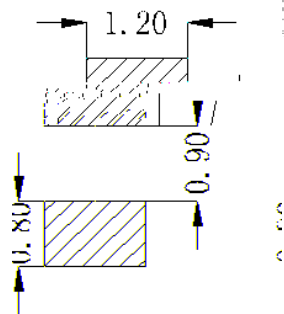
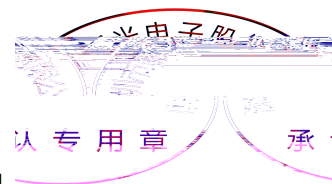

Fig.1-5 Soldering Patterns

Notes

1. All dimensions units are millimeters.
2. All dimensions tolerances are ± 0.2 mm unless otherwise noted.



± 0.2

1.5 Product Parameters

Table 1-1 Electrical / Optical Characteristics at Ts=25°C

Item	Symbol	Test Condition	Value			Unit
			Min.	Typ.	Max.	
Forward Voltage	V_F	$I_F=30\text{mA}$	2.7	3.0	3.3	V
Reverse Current	I_R	$V_R=5\text{V}$	Not designed for reverse operation			μA
Luminous Intensity	I_V	$I_F=30\text{mA}$	2300	2450	3500	mcd
Viewing Angle		$I_F=30\text{mA}$	---	120		

Table 1-2 Absolute Maximum Ratings at Ts=25°C

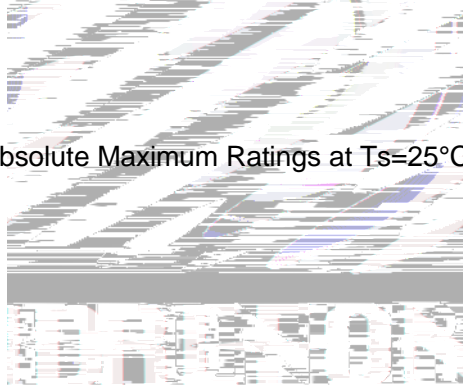

Notes

1. 1/10 Duty cycle, 10ms pulse width. 10ms, 1/10.
2. The above forward voltage measurement allowance tolerance is $\pm 0.1V$. $\pm 0.1V$.
3. The above color coordinates measurement allowance tolerance is ± 0.005 . ± 0.005 .
4. The above luminous intensity measurement allowance tolerance $\pm 10\%$. $\pm 10\%$.
5. Care is to be taken that power dissipation does not exceed the absolute maximum rating of the product.

6. All measurements were made under the standardized environment of Refond.

7. When the LEDs are in operation the maximum current should be decided after measuring the package temperature, junction temperature should not exceed the maximum rate. LED

8. ESD yield is over 90% at 8000V ESD (HBM). ESD protection during products handing is needed. 90% LED
ESD8000V ,

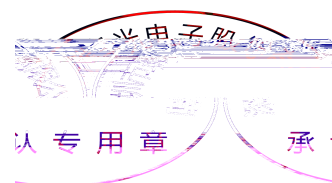
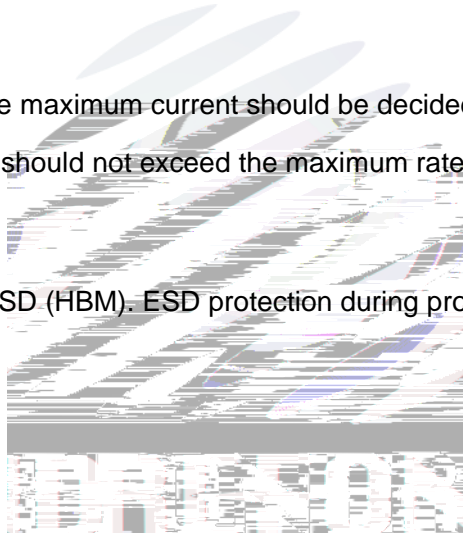

1.6Bin Range Of Forward Voltage and Luminous Intensity (IF=30mA)电压与发光强度分 BIN 范围(IF=30mA)

Table 1-3

V _F V	F2	G1	G2	H1	H2	I1
	2.7-2.8	2.8-2.9	2.9-3.0	3.0-3.1	3.1-3.2	3.2-3.3
IV(mcd)	N2	O1				

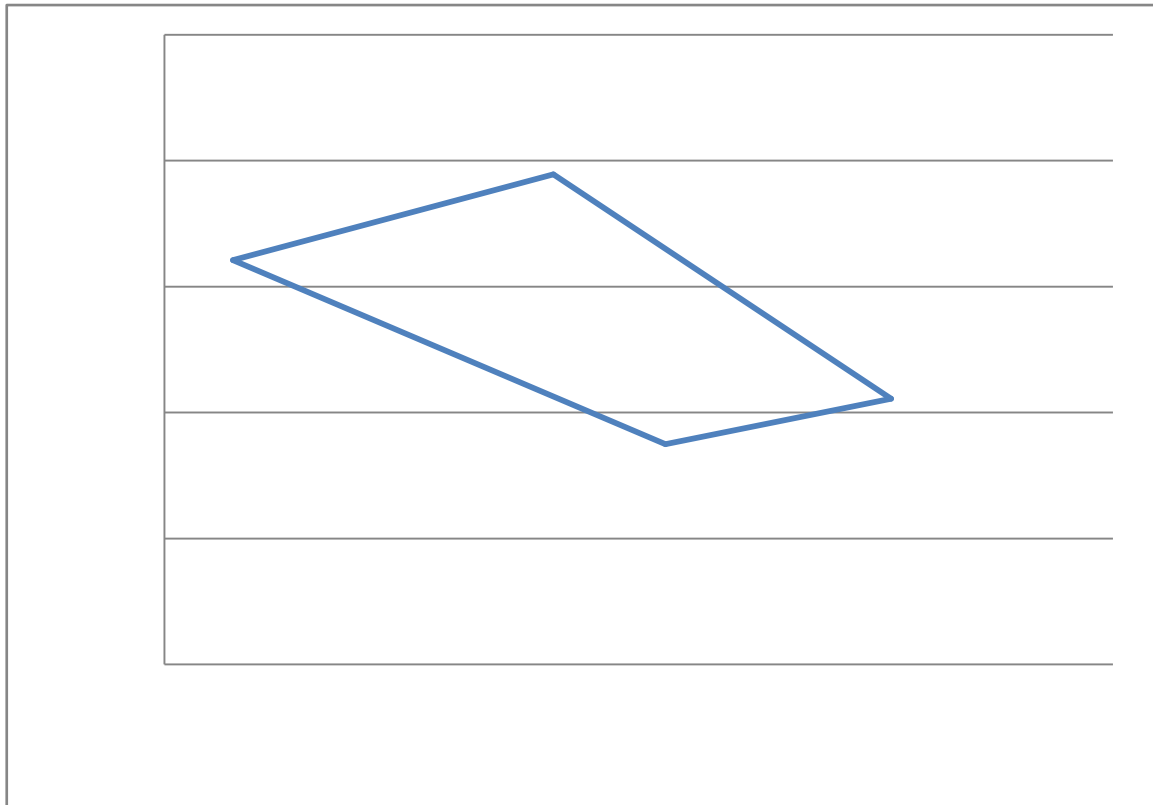

Fig. 1-6 The C.I.E Chromaticity Diagram CIE

Table 1-4

BIN CODE	CIE-X1	CIE-Y1	CIE-X2	CIE-Y2	CIE-X3
----------	--------	--------	--------	--------	--------

1.7 Typical Optical Characteristics Curves 典型光学特性曲线

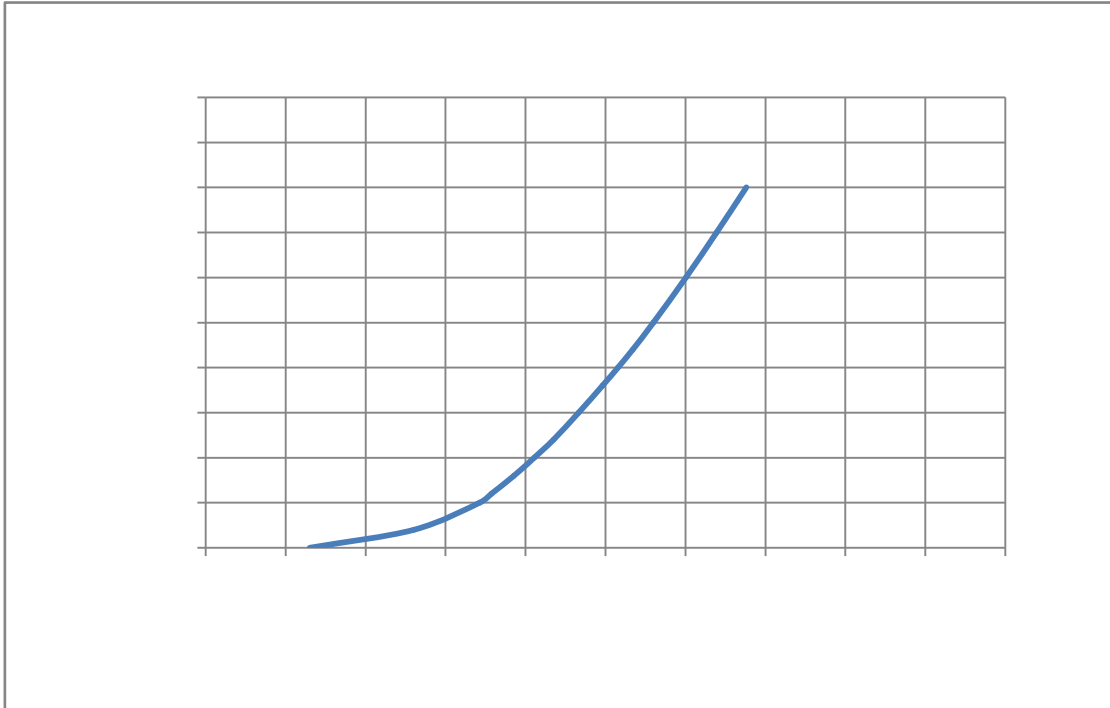

Fig. 1-7 Forward Voltage Vs Forward Current

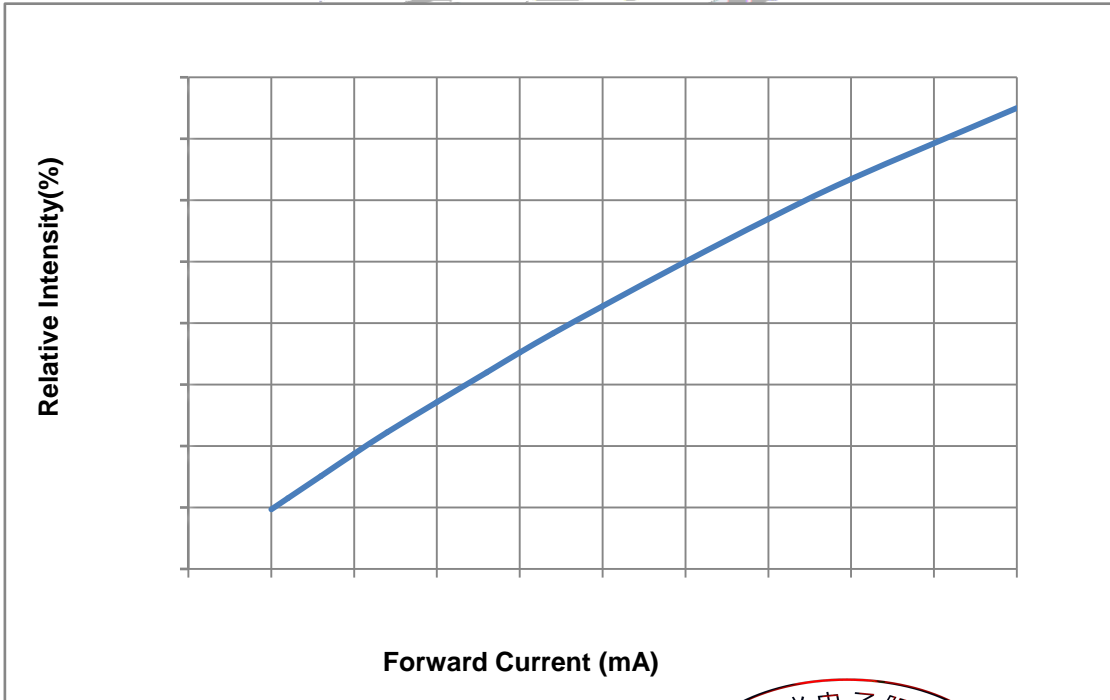
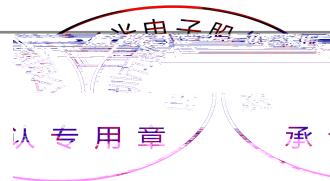

Fig. 1-8 Forward Current Vs Relative Intensity



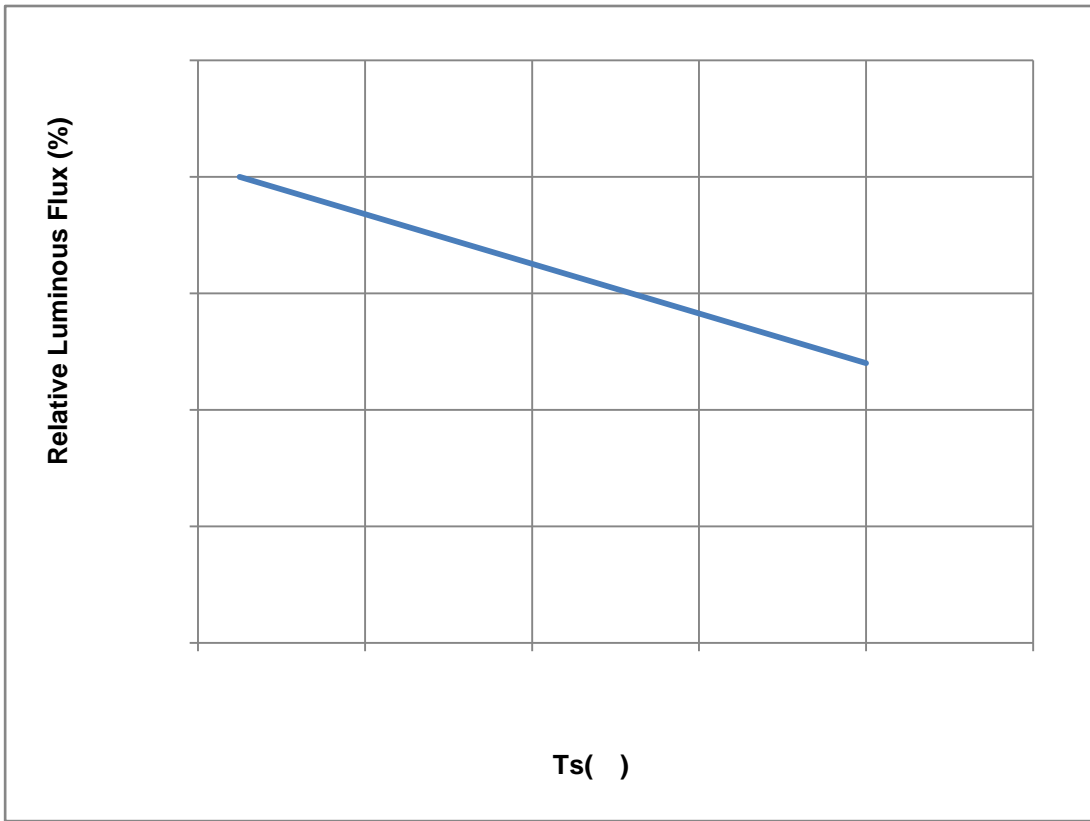

Fig. 1-9 Solder Temperature Vs Relative Intensity

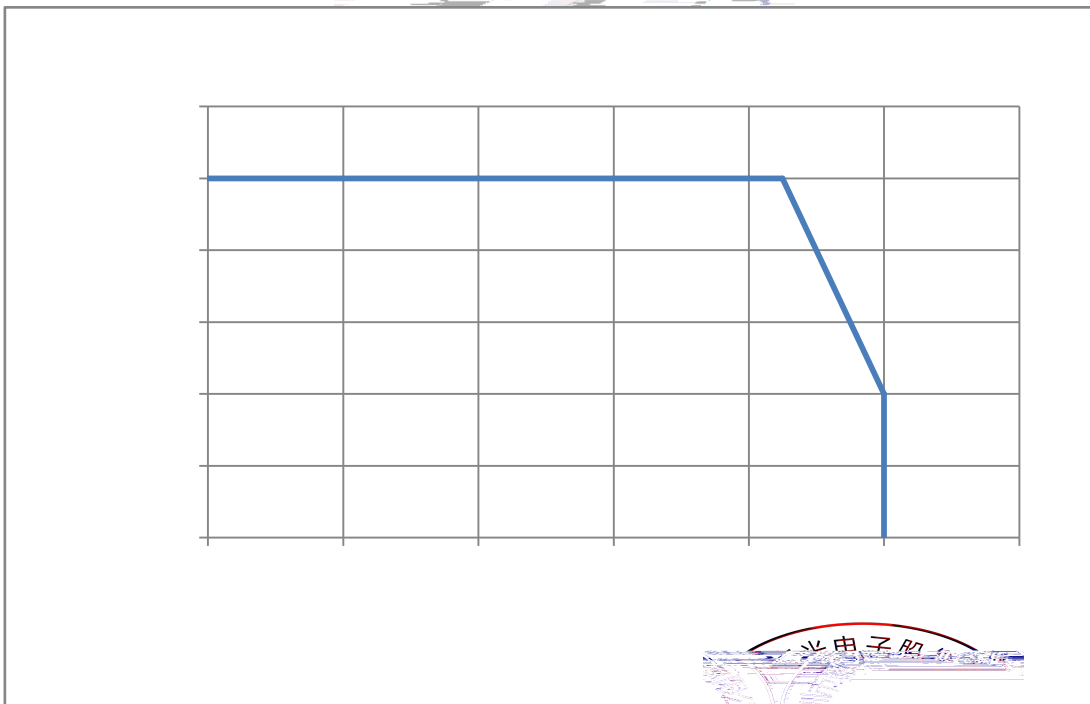
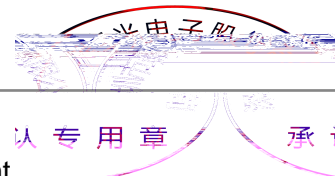

Fig. 1-10 Solder Temperature Vs Forward Current



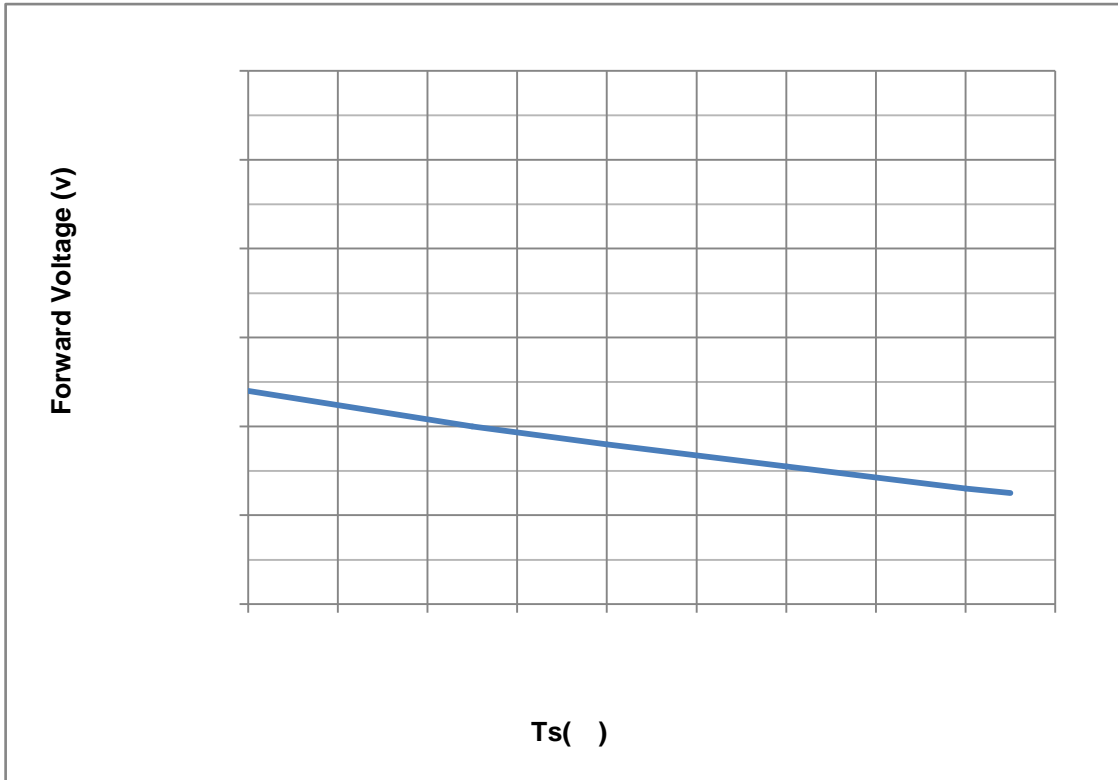

Fig. 1-11 Forward Voltage Vs Solder Temperature

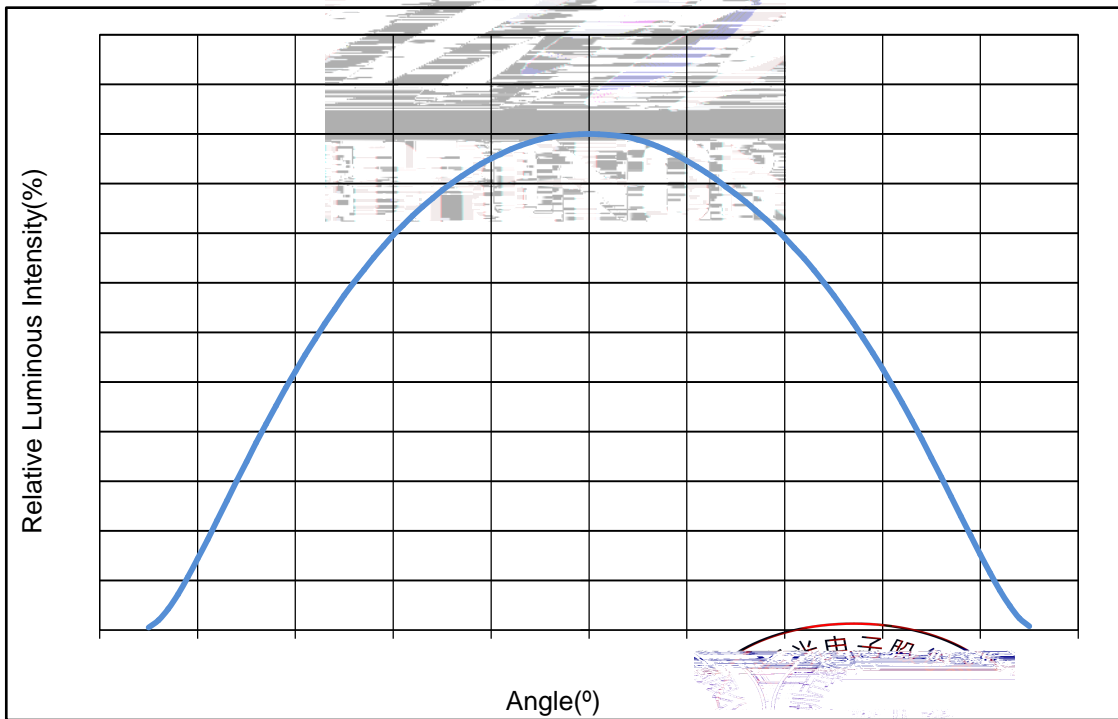
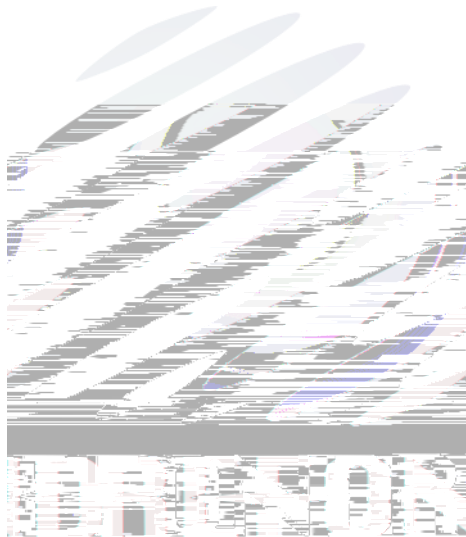

Fig. 1-12 Radiation diagram



2. Packaging 产品包装

2.1 Packaging Specification 包装规格

Package:3000pcs/reel.

2.1.1 Carrier Tape Dimension

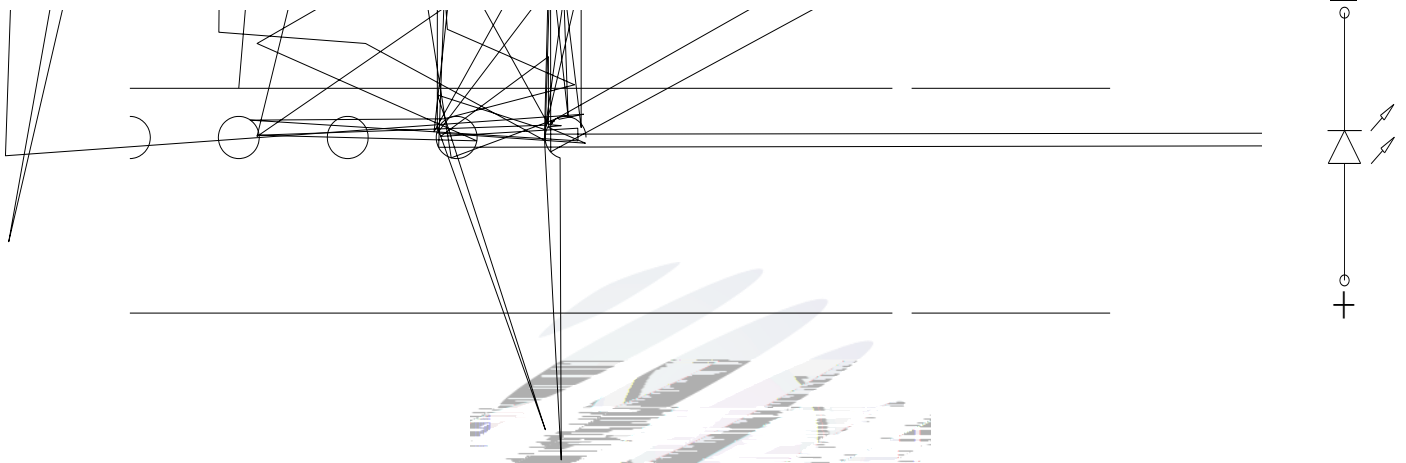

Fig.2-1 Carrier Tape Dimension

2.1.2 Reel Dimension

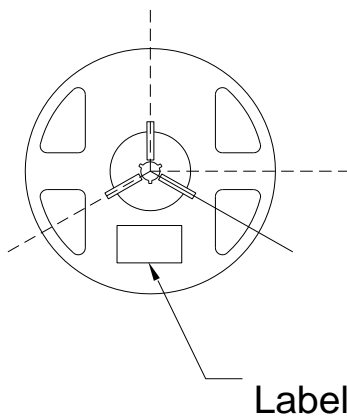

Fig.2-2 Reel Dimension 卷盘尺寸

Table 2-1 Reel Dimension 卷盘尺寸

A	8.0±0.1mm
B	178±1mm
C	60±1mm
D	13.0±0.5mm

Notes

The tolerances unless mentioned ±0.1mm. Unit : mm

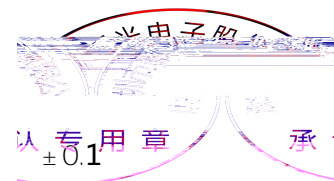

2.1.3 Label Form Specification

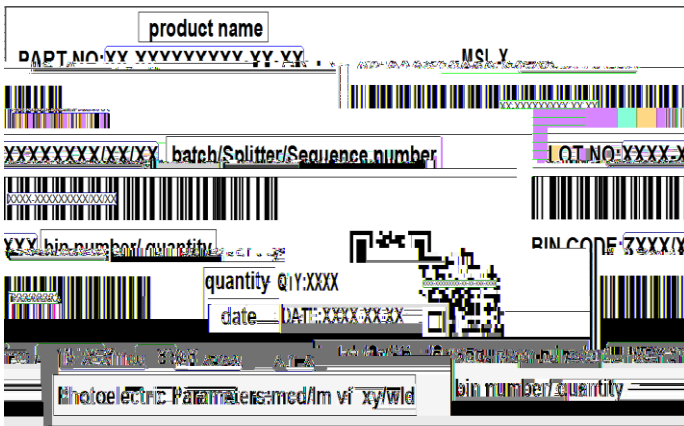

Fig. 2-3 Label Form Specification

Table 2-2 Specification

PART NO.	Part Number
SPEC NO.	Spec Number
LOT NO.	Lot Number
BIN CODE	Bin Code
	Luminous flux
XY	Chromaticity Bin
V _F	Forward Voltage
WLD	Wavelength
QTY	Packing Quantity
DATE	Made Date

2.2 Moisture Resistant Packing 防潮包装



Fig.2-4 Moisture Resistant Packing 防潮包装

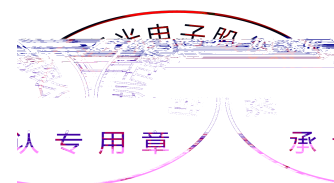

2.3 Cardboard Box 包装纸箱

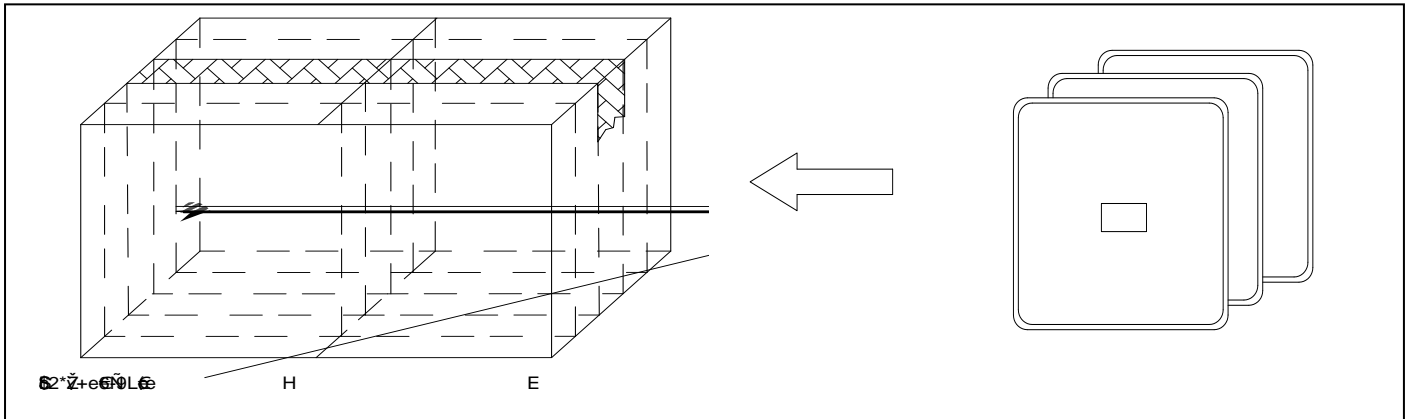

Fig.2-5 Cardboard Box 包装纸箱

2.4 Reliability Test Items And Conditions 信赖性测试项目及条件

Table 2-3 Reliability Test Items And Conditions

Test Items	Ref. Standard	Test Condition	Time	Quantity	Ac/Re
Reflow	JESD22-B106	Temp:260 max T=10 sec	2times	20pcs.	0/1
Thermal Shock	JEITAED-4701 300307	-40 15min 10s 125 15min	1000 cycle	20pcs.	0/1
High Temperature Storage	JEITAED-4701 200 201	Temp:125	1000hrs.	20pcs.	0/1
Low Temperature Storage	JEITA ED-4701 200 202	Temp:-40	1000hrs.	20pcs.	0/1
Life Test	JESD22-A108	Ta=25 If=30mA	1000hrs.	20pcs.	0/1

High Temperature High Humidity Life Test	JESD22-A101	85 / 85%RH I _F =30mA	1000hrs.	20pcs.	0/1
Temperature Humidity Storage	JEITA ED-4701 100 103	T _A =85 R _H =85%	1000hrs.	20pcs.	0/1

2.5 Criteria For Judging Damage 失效判定标准

Table 2-4 Criteria For Judging Damage

Test Items	Symbol	Test Condition	Criteria For Judgement	
			Min.	Max.
Forward Voltage	V _F	I _F =30mA	-	U.S.L*)x1.1
Reverse Current	I _R	V _R = 5V	-	U.S.L*)x2.0
Luminous Flux		I _F =30mA	L.S.L*)x0.7	-

Notes

- 1.U.S.L: Upper standard level L.S.L: Lower standard level
- 2.The above reliability tests is based on the verification of a single/strip LED of Refond's existing experimental platform,the reliability experiment was taken under good heat dissipation conditions, when customers applies the LED to the series and parallel circuit, should take consideration of all the factors such as the current, voltage distribution, heat dissipation and others.

LED

LED 承 / 章 用 专 认

3.The technical information shown in the data sheets is limited to the typical characteristics and circuit examples of the referenced products. It does not constitute the warranting of industrial property nor the granting of any license.

3. SMT Reflow Soldering Instructions SMT 回流焊说明

3.1 SMT Reflow Soldering Instructions SMT 回流焊说明

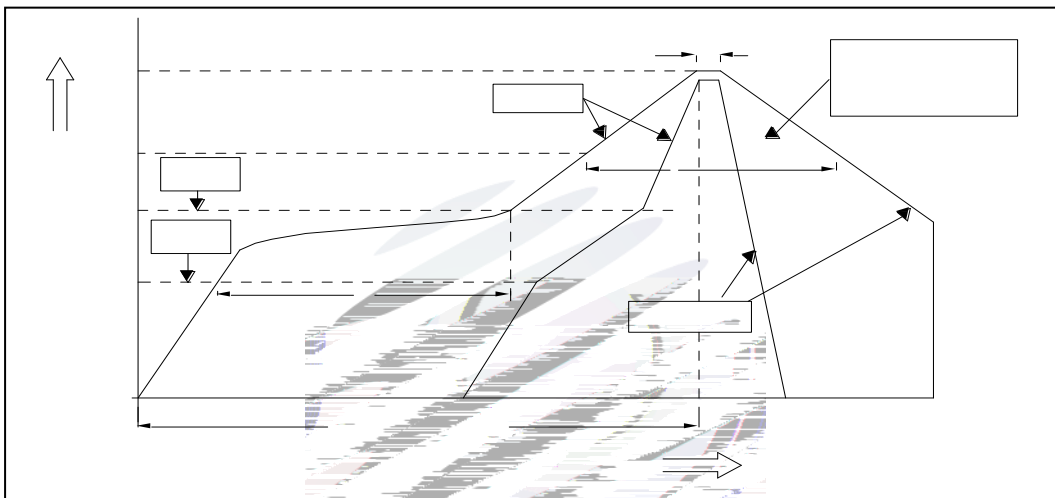

Fig.3-1 SMT Reflow Soldering Instructions SMT 回流焊说明

Table 3-1 Reflow parameters 回流焊参数

Average temperature rise speed	$T_{smax} - T_p$	3 °C/ s Max 3 °C/ s
Preheating: minimum temperature	(T_{smin})	150 °C
Preheating: Max temperature	(T_{smax})	200 °C
Preheating: Time	$T_{smin} - T_{smax}$	60 - 120 60s-120s
Time limited to maintain high temperature: the temperature	(T_L)	217 °C
Time limited to maintain high temperature: The Time	(t_L)	60 Max 60s

Peak /Classification of temperature: / (T _P)	260 °C
Time limit classification of peak temperature time t _p	10 Max 10s
(T _P) 5 °C Hold time within 5 °C with the actual peak temperature (TP)	30 Max 30s
Cooling speed	6 °C/ Max 6 °C/ s
25 °C Needed time from 25 °C to T _p	8 Max 8 minutes

Notes

(1)Reflow soldering should not be done more than twice. If more than 24 hours between the two solderings , LED will be damaged.

24 LED

(2)Whensoldering , do not put stress on the LEDs during heating.

3.1.1 Soldering Iron

(1) When do soldering by hand, keep the temperature of iron below less 300°C less than 3 seconds.

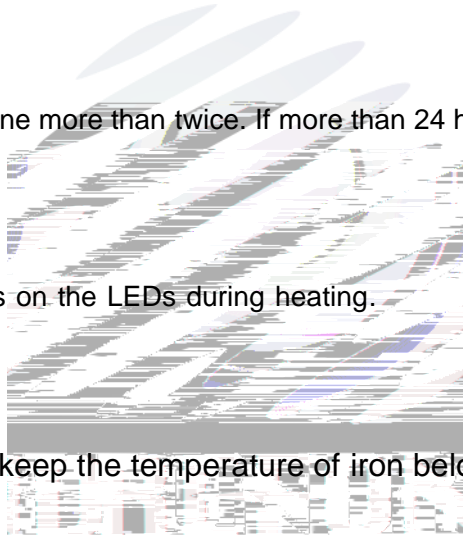

3.1.3 Cautions

(1) The encapsulated material of the LEDs is silicone. Therefore the LEDs have a soft surface on the top of package. The pressure to the top surface will be impacted on the reliability of the LEDs. Precautions should be taken to avoid the strong pressure on the encapsulated part. So when use the picking up nozzle, the pressure on the silicone resin should be proper. LED

LED

(2) Components should not be mounted on warped (non coplanar) portion of PCB. After soldering, do not warp the circuit board. LED PCB

(3) Do not apply mechanical force or excess vibration during the cooling process to normal temperature after soldering. Do not rapidly cool device after soldering.

4. Handling Precautions 产品使用注意事项

4.1 Handling Precautions 产品使用注意事项

(1) LED operating environment and sulfur element composition cannot be over 100PPM in the LED mating usage material. This is provided for informational purposes only and is not a guarantee.

(3) VOCs (Volatile organic compounds) emitted from materials used in the construction of fixtures can penetrate silicone encapsulants of LEDs and discolor when exposed to heat and photonic energy. The result can be a significant loss of light output from the fixture. Knowledge of the properties of the materials selected to be used in the construction of fixtures can help prevent these issues. Refond advises against the use of any chemicals or materials that have been found or are suspected to have an adverse effect on device performance or reliability. To verify compatibility, Refond recommends that all chemicals and materials be tested in the specific application and environment for which they are intended to be used. Attaching LEDs, do not use adhesives that outgas organic vapor.

LED

LED

LED

(4) Handle the component along the side surface by using forceps or appropriate tools; Do not directly touch or Handle the silicone lens surface, it may damage the internal circuitry.

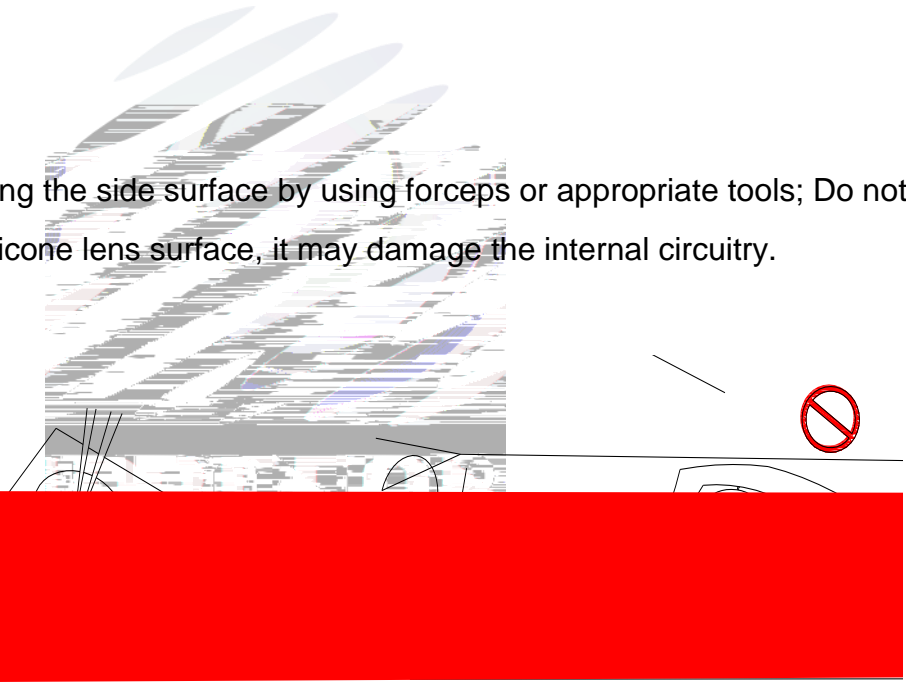
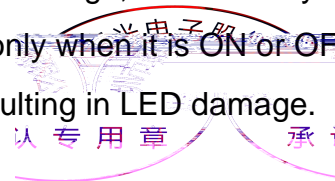

Fig 4-1 Handling Precautions

(5) In designing a circuit, the current through each LED can not exceed the absolute maximum rating specified for each LED. In the meanwhile, resistors for protection should be applied, otherwise slight voltage shift will cause big current change, burn out may happen. The driving circuit must be designed to allow forward voltage only when it is ON or OFF. If the reverse voltage is applied to LED, migration can be generated resulting in LED damage.

LED



LED

(6) Thermal Design is paramount importance because heat generation may result in the Characteristics decline, such as brightness decreased, Color change and so on. Please consider the heat generation of the LEDs when making the system design. LED

LED

(7) Compared to standard encapsulants, silicone is generally softer, and the surface is more likely to attract dust, requiring special care during processing. In cases where a minimal level of dirt and dust particles cannot be guaranteed, a suitable cleaning solution must be applied to the surface after the soldering of components. Refond suggests using isopropyl alcohol for cleaning. In case other solvents are used, it must be assured that these solvents do not dissolve the package or resin. Ultrasonic cleaning is not recommended. Ultrasonic cleaning may cause damage to the LED.

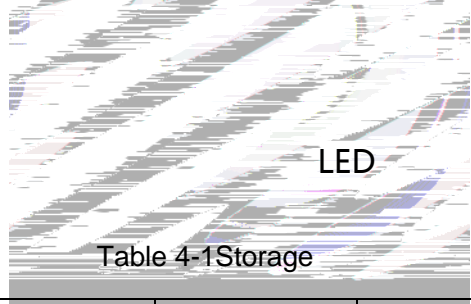

Table 4-1 Storage

Conditions		Temperature	Humidity	Time
Storage	Before Opening Aluminum Bag	30	75%	Within 1 Year From Date
	After Opening Aluminum Bag	30	60%	Recommended for use within 24 hours

Baking

(8) If the moisture absorbent material (silica gel) has faded away or the LEDs have exceeded the storage time,baking treatment should be performed after unpacking and based on the following condition (65 ± 5) °C for above 24 hours.

60 ± 5 24

If the package is flatulence or damaged,please notify the sales staff to assist.

(9)Similar to most Solid state devices; LEDs are sensitive to Electro-Static Discharge (ESD) and Electrical Over Stress (EOS). LED

(10) Other points for attention, please refer to our relevant information.

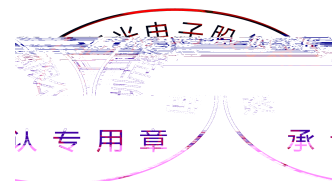
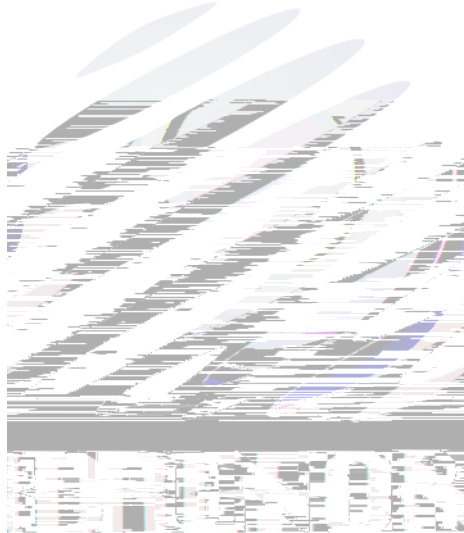

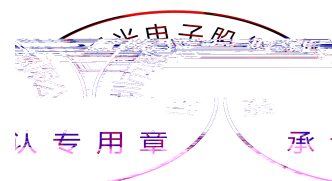

Declare

This specification is written both in English and in Chinese and the latter is formal.